



ANNIN ROBOTICS



Build Manual Version 1.8

AR4-MK3 Robot Manual
Free Design 6 axis robot

Contents:

- [Electrical Safety](#)
- [Overview](#)
- [Chapter 1 – Robot Bill of Materials](#)
- [Chapter 2 – Robot Assembly](#)
- [Chapter 3 – PLC Modbus Option](#)
- [Chapter 4 – Pneumatic Gripper](#)
- [Chapter 5 – Servo Gripper](#)
- [Chapter 6 – Addition Axis](#)
- [Chapter 7 – Spec's / Diagrams](#)
- [Chapter 8 – Startup Procedure](#)
- [Chapter 9 – Programming](#)
- [Version Log](#)



Electrical Safety

- ▶ **ELECTRIC SHOCK HAZARD.** The construction of this control enclosure poses potential exposure to alternating current and direct current which has the potential to cause injury or death. This equipment should be constructed and serviced by trained or qualified persons.
- ▶ Keep the area around the device clear and free from dust before, during, and after installation.
- ▶ Wear safety glasses if you are working under any conditions that could be hazardous to your eyes.
- ▶ Do not perform any actions that create a potential hazard to people or make the equipment unsafe.
- ▶ Never install or manipulate wiring during electrical storms.
- ▶ Never install electrical jacks in wet locations unless the jacks are specifically designed for wet environments.
- ▶ Operate the device only when it is properly grounded.
- ▶ Ensure that the separate protective earthing terminal provided on this device is permanently connected to earth.
- ▶ Replace fuses only with fuses of the same type and rating.
- ▶ Do not open or remove chassis covers or sheet-metal parts unless instructions are provided in the hardware documentation for this device. Such an action could cause severe electrical shock.
- ▶ Do not push or force any objects through any opening in the chassis frame. Such an action could result in electrical shock or fire.
- ▶ Avoid spilling liquid onto the chassis or onto any device component. Such an action could cause electrical shock or damage the device.
- ▶ Avoid touching uninsulated electrical wires or terminals that have not been disconnected from their power source. Such an action could cause electrical shock.
- ▶ Always ensure that all modules, power supplies, and cover panels are fully inserted and that the installation screws are fully tightened.



OVERVIEW

About building this robot:

The AR4 is an open design 6 axis robot that anyone can build. All software, print files and manuals are available for download on the Annin Robotics website downloads page. All the components you need to build this robot are outlined in Chapter 1. The assembly of the robot arm is outlined in Chapter 2. Chapter 3 covers the installation of a pneumatic gripper on the robot and Chapter 4 covers the installation of a servo gripper on the robot. (both chapters on robot grippers have a separate bill of materials listing the items needed for each type of gripper).

Components Needed to Build this Robot:

The following is an overview of the 5 component groups needed:

- **3D covers and spacers** (you must print these yourself) see chapter one “spacers and covers” section.
- **Structural components** - You can print these yourself to build a 3D printed robot or you can purchase an aluminum parts kit from the robot kits page to build your robot from aluminum <https://www.anninrobotics.com/robot-kits>. There are 27 structural components – see chapter one “structural components” section.
- **Hardware components** – this includes the bearings, belts, pulleys, sprockets, chain, shafts, pins, machine screws and set screws. These can be purchased from multiple sources – see chapter one “hardware components” section. If you have difficulty finding these component or wish to buy them all in one place I buy them all in bulk and have made a hardware components kit available on the robot kits page: <https://www.anninrobotics.com/robot-kits>.
- **Stepper Motors and Drivers** – the 6 motors, drivers and power supply are available directly from Stepperonline, there is a link to this package on the robot kits page: <https://www.anninrobotics.com/robot-kits>.
- **Electrical components** – The primary electrical components can be purchased on the robot kits page or can be sources separately – all parts are listed in the bill of materials.



General Robot Assembly notes:

- Use low strength thread locking compound on screws sized M4 and larger. Do not use thread locking compound and M3 and smaller.
- All belts should be tensioned using moderate tension (do not over tighten or stress belts or components).

Tools & Materials Needed:

- General hand tools including metric hex key set, locking pliers, wire cutters, wire strippers.
- Soldering Iron and flux core silver bearing solder.
- 1.5mm or 2mm heat shrink tubing for most connections. A short length of 6mm heat shrink tube is used for the servo gripper in chapter 4.
- Heat gun or lighter for shrink tubing.
- Digital calipers.
- 3D printer and printer filament.
- Various size drill bits for clearing holes in 3D printed components.
- M3 and M4 taps for threading plastic components.
- Epoxy is used for the J6 limit switch tip. Epoxy is also used in some areas of the robot assembly when using 3D printed components.
- A digital level is recommended to assist in fine tuning the robots auto calibration.
- A general angle gauge is used to set the position of Joint #5.
- White lithium grease or general-purpose grease.
- Bearing retaining compound.
- Low strength thread locking compound.
- Liquid electrical tape.
- Cable ties, medium and small.

Bearing Fit:

The CAD models for the AR4 robot are sized for a slight press fit on all bearing and race diameters. The assembly steps in this manual also reference pressing the bearings and races in place. I have tried to make sure the aluminum kits offered are closer to a slip or light press fit. If bearings get improperly wedged or tilted and then attempt to press, severe damage can occur – use a quality bearing press, arbor press or vise and be very careful that bearing races are pressed or inserted square and true to the housing body. **NEVER USE A HAMMER.** Aluminum housings can be heated with a heat gun or mug warmer to increase size and assist in inserting bearings. If the tolerance stack up on your components results in a race that is slightly loose, please use bearing retaining compound to alleviate any movement. If the tolerance stack up of your components result in a shaft that is slight too tight shafts can be carefully polished until a slip fit is achieved - bearings can also be warmed up with a heat gun or placed on a mug warmer to slightly increase size and make insertion onto aluminum shafts a little easier.

▶ A small amount of white lithium or standard bearing grease is recommended on all bearings.

3D Printing Your Robot:

This manual shows the construction of the robot using aluminum for the main structural components but the robot can also be constructed using all 3D printed components. The .stl print files for all components are here: <https://www.anninrobotics.com/downloads> The construction illustrated in this manual is the same using either aluminum or 3D printed components - note the following details if using 3D printed components:

- 3D printed components require all threaded holes to be cleared with appropriate drill size and then tapped.
- All printed structural components were printed at minimum 50% infill with the exception of the J2 and J3 drive spindles and tension rings which were printed at 90%+ solid. Parts were printed at 2mm layer height and 5 layer thick shells.
- All printed covers and spacers were printed at 20% infill at .2mm layer height and 5 layer thick shells.
- The robots I have 3D printed were made using ABS at 220° nozzle temperature. I have not personally tried using other materials but I have received feedback from numerous people who have used PLA, PETG and carbon fiber reinforced filaments without issues.
- The J1 baseplate, J1 baseplate spacer and J2 arm larger than most 3D printer beds and therefore are printed in 2 pieces and require being epoxied together.
- The J1 spindle is printed in 2 pieces and requires the center alignment plug be epoxied into the end of the spindle – this is the center hub that centers the 60T timing pulley.
- The printed design calls for additional reinforcements to be epoxide in place around the J1 base and at the base of the J2 arm (see details at the end of this manual)
- The J4 tube cannot be 3D printed; if building a fully 3D printed robot you will need to cut and drill aluminum tubing as shown in structural components BOM section of chapter 1.
- 2 spools of filament are needed for printing the primary structural components. A 3rd spool is needed if you wish to print your covers and spacers in a different color.

GRIPPERS AND 5V DEVICES:

The software has the ability to control grippers or any other clamp or servo device you need the robot to control. When you review the chapters on pneumatic and servo grippers you will find an additional Arduino board is needed. The reason for this is that the Teensy board operates at 3.3v and has limited pins available therefore I wrote the software to use this Arduino Nano or Mega board for controlling peripheral devices – also this board operates at 5v and 5v relays and servos are much more common and reliable than 3.3 which is why the teensy is only used for control of the robot arm.



Using Braided Sleeve

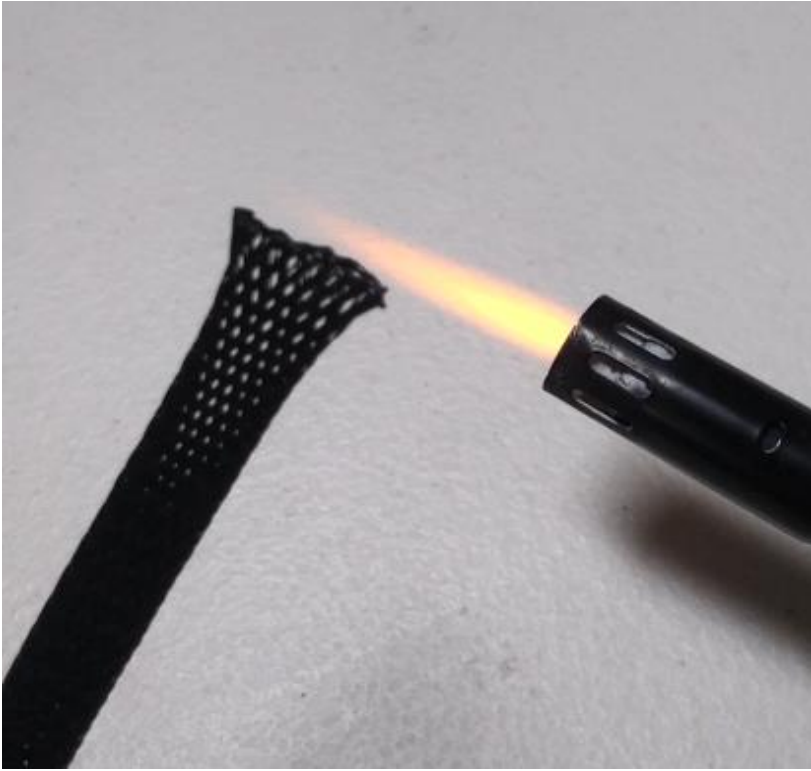

Several Steps in this manual will call for braided sleeve to be placed over electrical wires. Make sure that as soon as you cut any braided sleeve you use a lighter or flame to carefully melt the ends of the sleeve as shown.

If you do not melt the ends the sleeve will un-braid and not hold the wires together.



Soldering Wire Connections

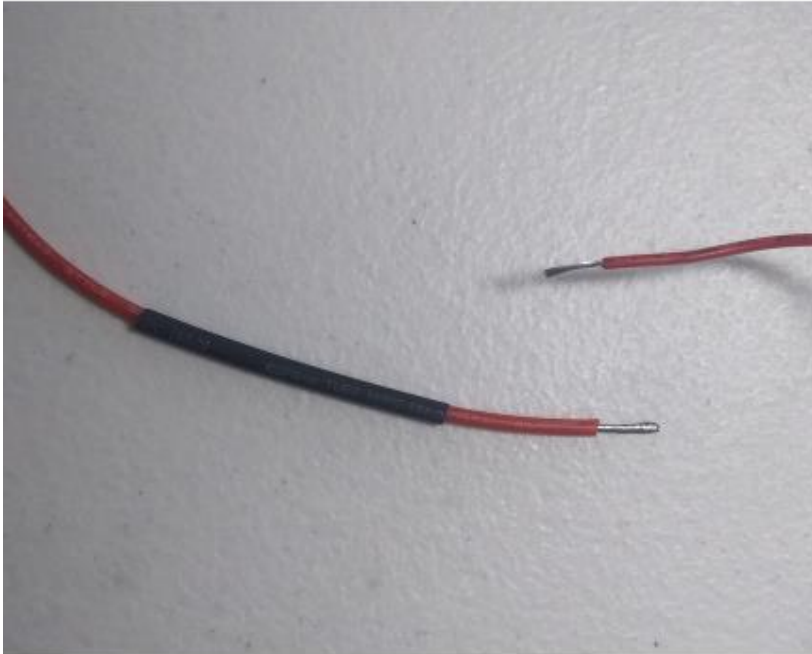

Several steps in this manual will call for soldering and heat shrinking wire connections together.

Strip wire ends of both wires and twist wire strands.

Insert length of heat shrink tube over one of the wire ends.

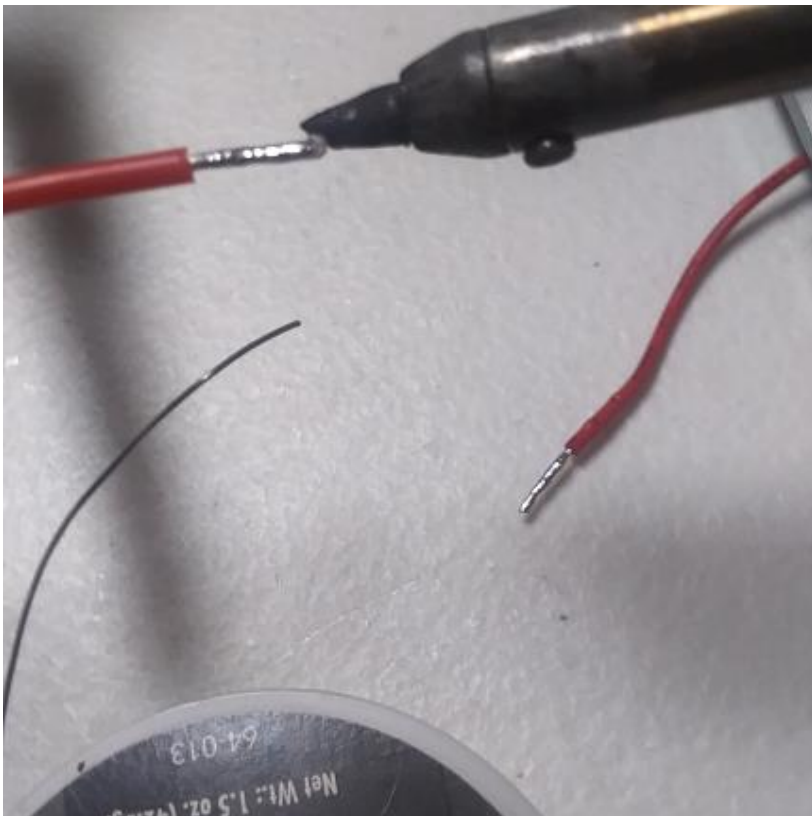

Use soldering iron and rosin core electrical solder to pre apply solder to the ends of each wire.

This is also known as “tinning” the wire end.



Use soldering iron to melt solder on both wire ends so that wire ends are overlapping and solder forms a complete bond between the two wire ends.

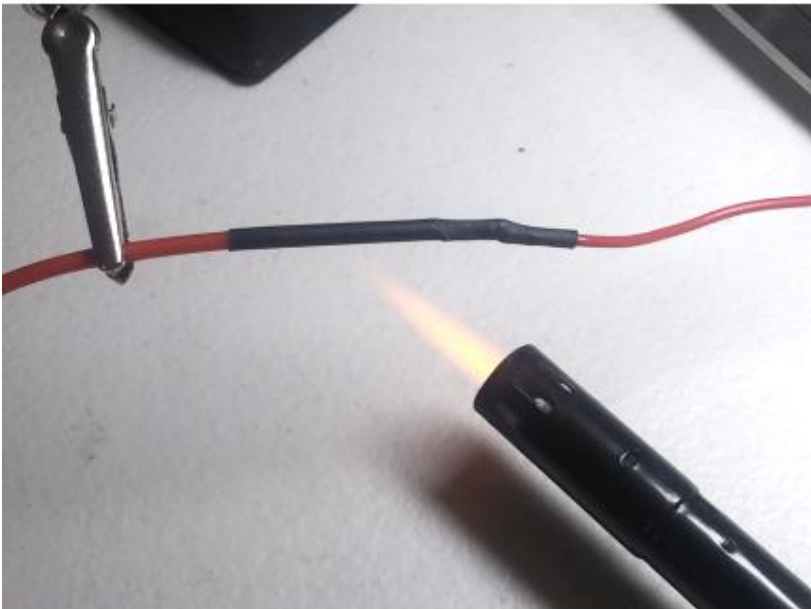

Slide the heat shrink tube over the solder joint and then use a lighter flame to shrink the tubing over the joint.

Gently sweep the flame back and forth over the heat shrink tubing taking care not to apply too much heat.

Do not use open flame around any combustible materials and be careful not to inadvertently melt any of your plastic components or braided sleeve.



Removing jacket and shielding from continuous flex Cat6 cable

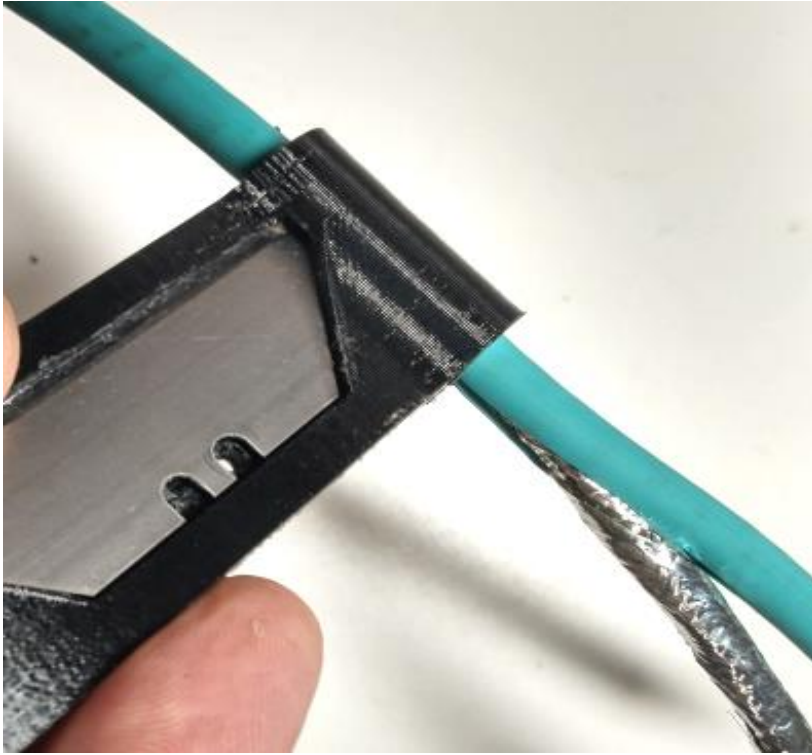

Install razor blade into 3D printed CF Cat6 Jacket Stripper and then feed cable through the round passage in tool.

The jacket will be split as it passes through and you can then peel off the jacket.



Remove foil wrap from around cable shielding.

Several steps in the manual will call for removing a length of shielding from the end of Cat6 cable.

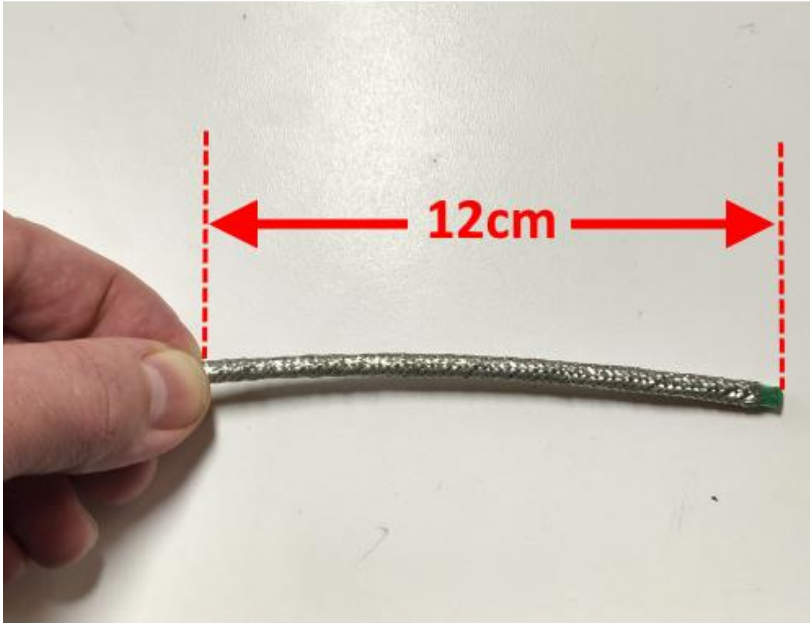

In this example I will remove 12cm of shielding.

In one hand pinch the cable at the position you want to remove the shielding from.

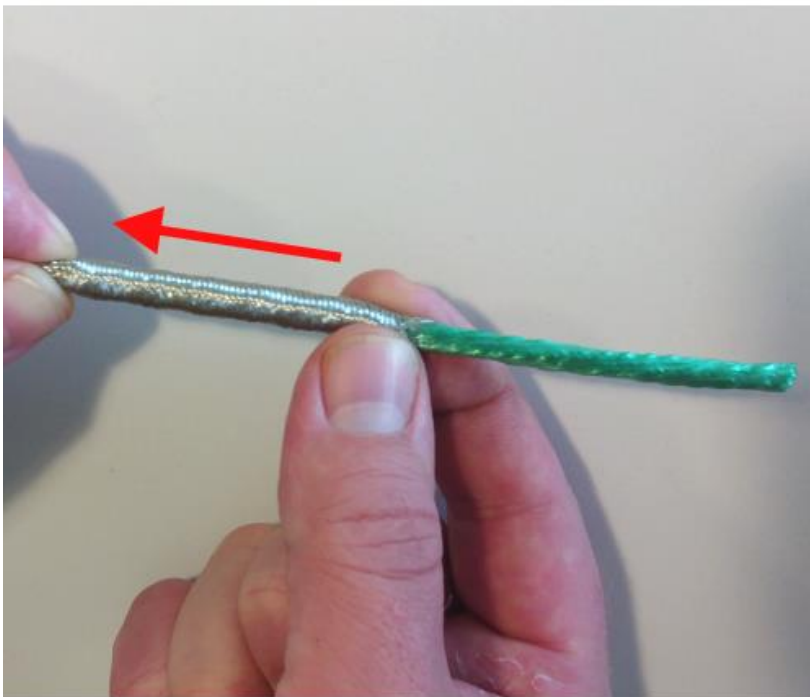

Keep the cable pinched at the 12cm point and then push or bunch up the shielding to be removed toward the pinch point.





At the 12cm pinch point use a pair of sharp point cutters to get under the bunched up shielding.

CAUTION: be extremely careful to only get cutter blade under the shielding, it is very easy to accidentally snag and cut one of the wires.



Carefully cut a portion of the shielding as shown. Be very careful to only cut shielding.

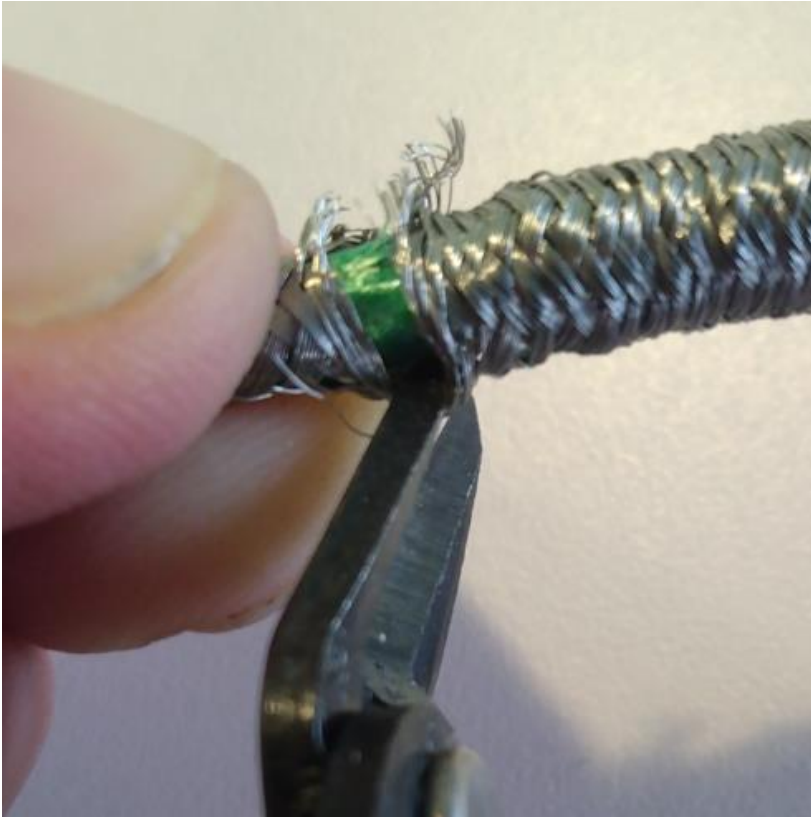

Carefully cut remaining shielding around perimeter of cable.

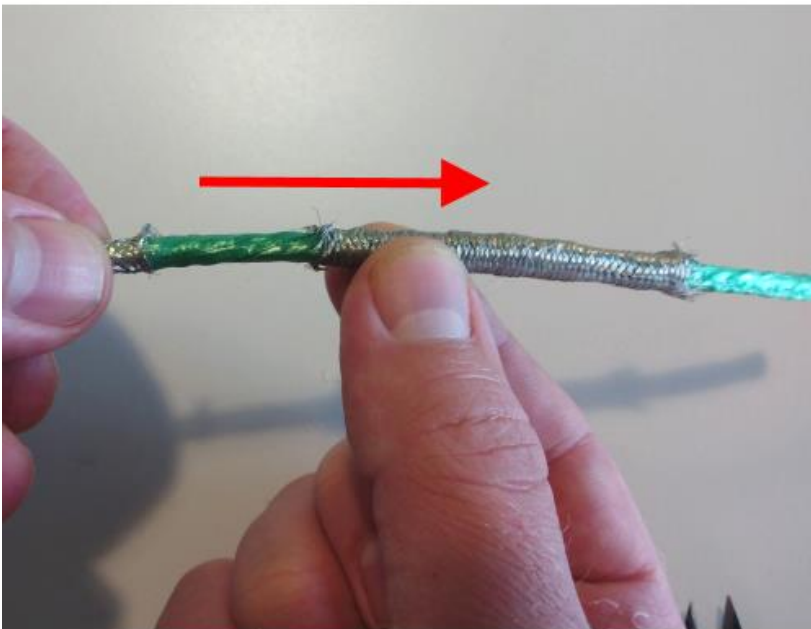

Remove shielding as shown.



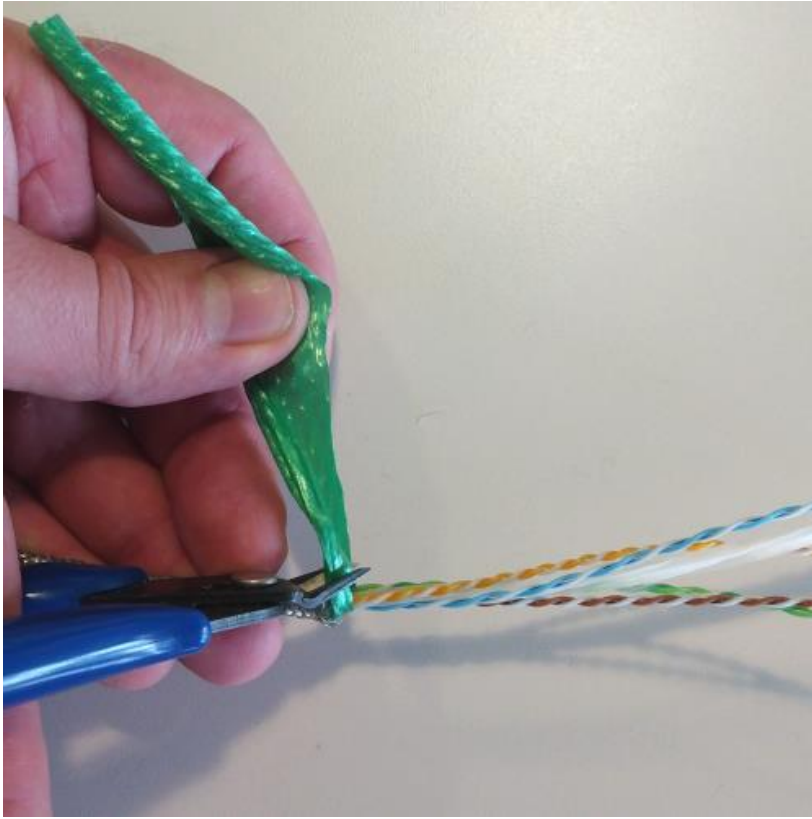

Remove and cut green wrap as shown.

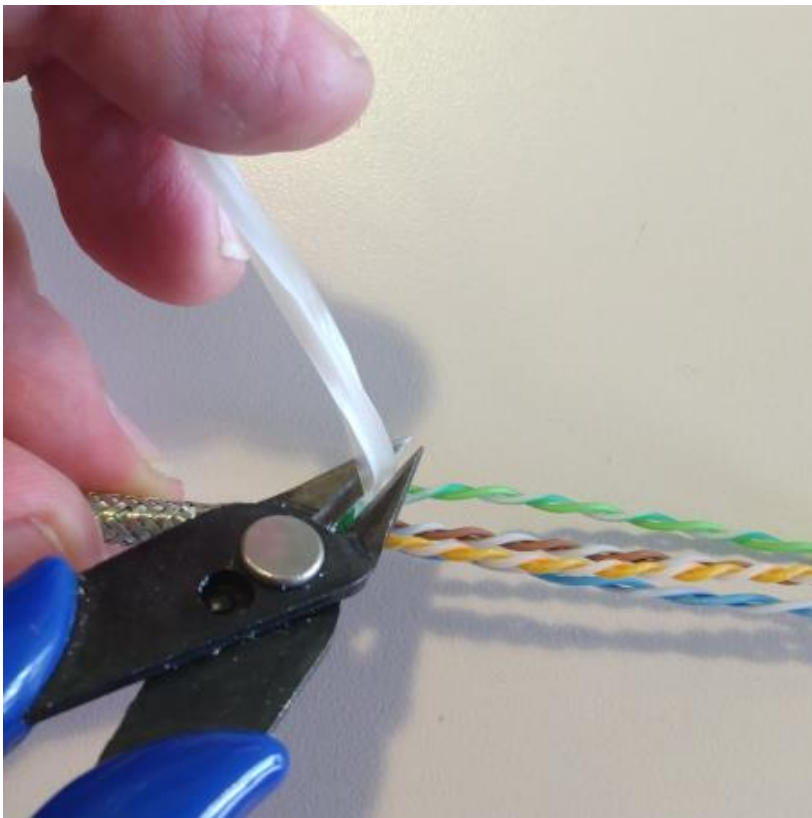

Separate plastic center core and carefully cut and remove.

CHAPTER 1

ROBOT BILL OF MATERIALS

- **STRUCTURAL COMPONENTS KIT**
 - These components are part of the AR4 build kit at <https://www.anninrobotics.com/robot-kits>
- **HARDWARE COMPONENTS KIT**
 - These components are part of the AR4 build kit at <https://www.anninrobotics.com/robot-kits>
- **ELECTRICAL COMPONENTS KIT**
 - These components are part of the AR4 build kit at <https://www.anninrobotics.com/robot-kits>
- **MOTORS AND DRIVERS PACKAGE FROM STEPPERONLINE**
 - These parts are available factory direct from Stepperonline as a discount package. There is a link to this package on the robot kits page.
- **3D PRINTED COMPONENTS**
 - These parts you need to print on your 3D printer (please see the overview section on 3D printed parts).

PLEASE ALSO REVIEW CHAPTERS 3 AND 4 TO MAKE SURE YOU HAVE THE COMPONENTS NEEDED FOR ANY GRIPPERS YOU MAY WANT TO INSTALL ON THE ROBOT.

DON'T FORGET TO REVIEW THE TOOLS AND MATERIALS SECTION IN THE OVERVIEW.



Structural Components



J1 BASE PLATE



J1 TURRET HOUSING



J1 SPINDLE

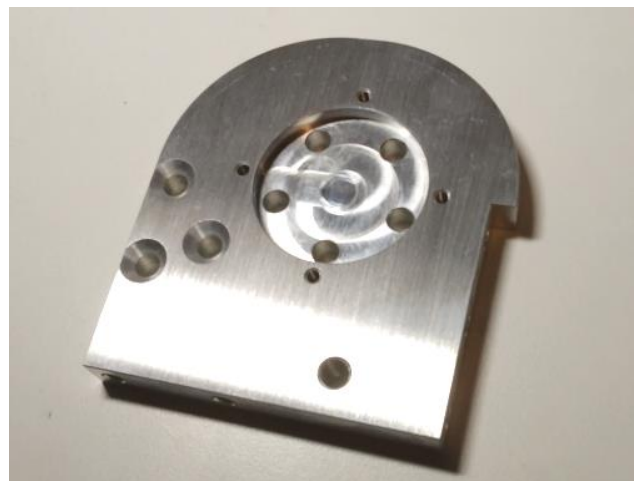

J1 PLATFORM



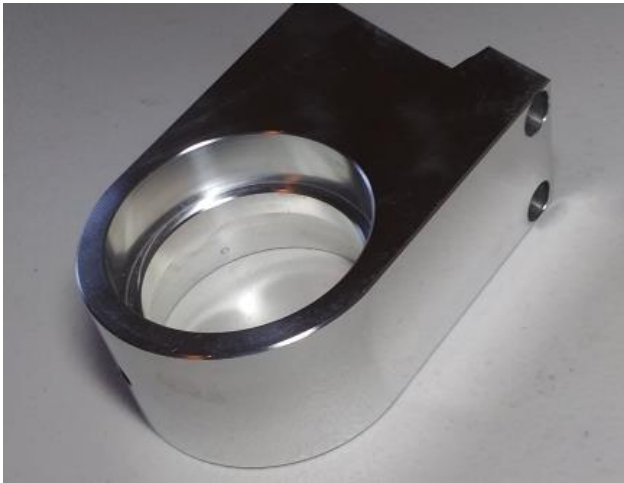

J2 TURRET HOUSING



J2 ARM



J2 DRIVE SPINDE



J2 TENSION RING



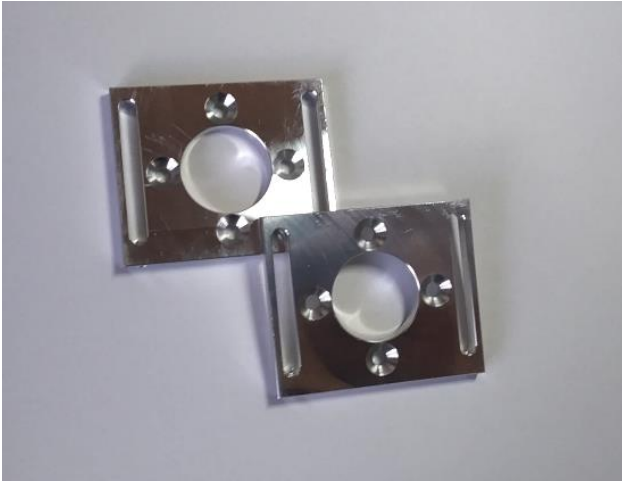

J1 & J3 MOTOR MOUNTS



J2 MOTOR SUPPORT

NOTE: Robot kits sold prior to 12/4/25 used a clamp style support – build instructions in chapter 2, page 112 will explain both versions.



J3 BEARING CUP



J3 SPINDLE





J3 SPINDLE RETAINER



J4 TURRET HOUSING



J4 MAIN SHAFT

(see note below on making your own J4 main shaft if you are not using aluminum parts kit and are 3D printing your robot)



J5 MOTOR MOUNT





J4 MOTOR MOUNT



J5 BELT CARRIER & J5 BELT CARRIER CLAMP



J5 HOUSING



J5 BEARING POST





J5 IDLER TENSION BLOCK



J6 MAIN BEARING ARM

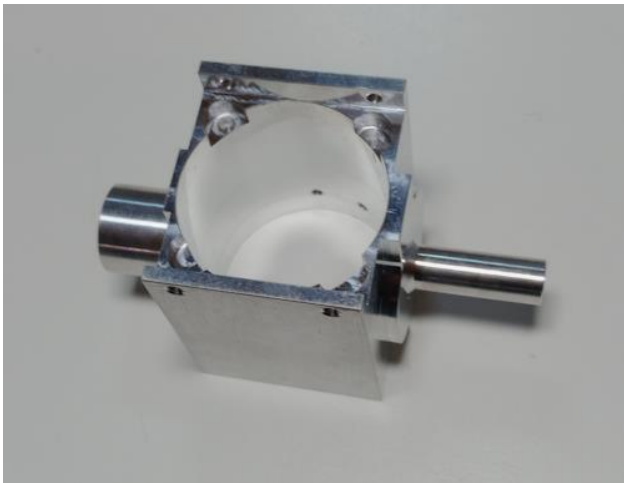

J6 HOUSING



J6 BEARING CAP





J6 GRIPPER MOUNT



Hardware Components



Qty. (2) 32009 (45x75x20mm) taper roller bearing.



Qty. (2) 30206 (30x62x17.25mm) taper roller bearing.



Qty. (1) 30204 (20x47x15.25mm) taper roller bearing.



Qty. (1) AXK3552/AS3552 (35x52x4mm) thrust bearing with washers.



Qty.(3) NTA1625 (1.00x1.5625x0.0781 inch) thrust bearing.



Qty.(4) TRA1625 (1.000x1.5625x0.0312 inch) thrust washers.





Qty.(2) TRD1625 (1.000x1.5625x0.125 inch) thrust washers.



Qty.(2) B1616 (1x1-1/4x1 inch) needle roller bearing.



Qty. (1) HK1612 (16x22x12mm) needle roller bearing.



Qty.(2) 3mm x 85mm shaft.

(If sourcing the parts yourself these are typically sold in lengths of 100mm so you would need to cut them down to 85mm)



Qty.(2) 3mm ID x 7mm OD x 20mm long brass bushing.



Qty.(1) 688Z (8x16x5mm) groove ball bearing.





Qty.(1) 30203 (17x40x13.25mm) taper roller bearing.



Qty.(1) 60T XL pulley.

(If sourcing your own parts this can be purchased from Amazon or Servo City as a black phenolic material which works fine - there is also a 3D print file for this part)

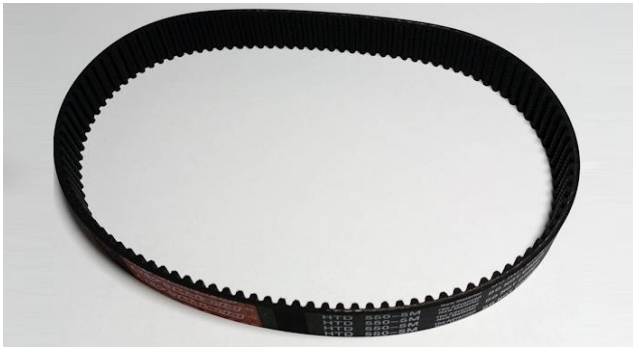

Qty.(1) HTD 550-5M belt.



Qty. (1) 180XL037 belt.



Qty.(1) 150XL037 belt.



Qty.(1) 84XL037 belt.





Qty (2) HTD-20 Pulleys (long and short)



Qty.(2) XL 15 tooth 8mm bore.

(one of them needs a 3mm key broach, the Annin Robotics hardware kit comes with a broached pulley but if you are sourcing your own parts they are not commonly broached for a key shaft)



Qty.(1) XL 10 tooth 6mm bore pulley



Qty.(1) 8mm keyed rotary shaft (you will need a length that is 50mm long)

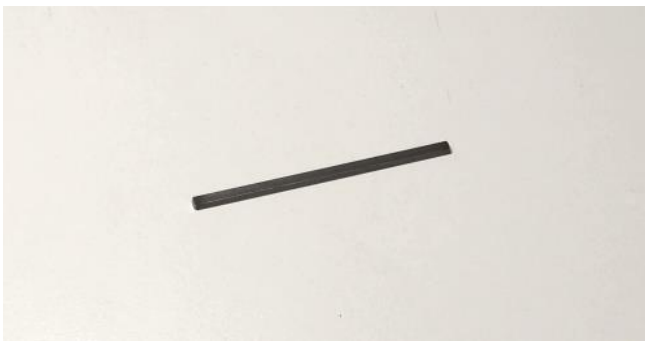

Qty.(1) – 2mm x 2mm keystick (you need a length 50mm long)



Machine Screws / Fasteners

#6 x .375 Thread Form Screw	26
M2.5 x 6 Pan Head screw	2
M2.5 x 8 Pan Head screw	6
M3 x 6 Button Head screw	1
M3 x 30 Pan Head screw	16
M3x10 Flat Head Screw	13
M3x10 Set Screw Screw	4
M3x14 Pan Head Screw	8
M3x14 Socket Head Screw	6
M3x16 Socket Head Screw	4
M3x20 Flat Head Screw	8
M3x20 Pan Head Screw	6
M3x25 Pan Head Screw	8
M3x3 Set Screw	5
M3x4 Set Screw	9
M3x6 Button head	1
M3x5 Set Screw	20
M3x5 Socket Head Screw	5
M3x6 Set Screw	7
M3x8 Socket Head Screw	5
M4 Nuts	4
M4 Washers	12
M4x10 Flat Head Screw	16
M4x10 Set Screw	11
M4x10 Socket Head Screw	16
M4x14 Flat Head Screw	2
M4x14 Socket Head Screw	1
M4x18 Flat Head Screw	6
M4x20 Pan Head Screw	2
M4x20 Socket Head Screw	8
M4x45 Pan Head Screw	4
M4x5 Set Screw	21
M6x14 Socket Head Screw	13
M6x18 Flat Head Screw	9
M6x20 Socket Head Screw	3
M8 x 14 Socket Head	1



Electrical Components



20awg flexible silicone wire in the following colors:

- Black
- Red
- Blue
- Green

3.2 meters of each color.



Continuous flex CAT5 or higher cable 26awg shielded.

(This needs to be stranded flex wire)

6.6 meters



Standard CAT5 or higher
cable.

(solid core wire is fine)

50cm



20awg 2 conductor black
and red wire..

37cm





1/4" braided sleeve.

3 meters



3/4" braided sleeve.

1.65 meters



PG-21 gland nut.

Qty (2)



RJ-45 Keystone Jack.

Qty (1)

USB-C 90 degree
Keystone Jack.

Qty(1)



Micro USB to USB-C cable
20cm long

Qty(1)



SV-166-1C25 Limit Switch.

Qty (3)



10T85 Limit Switch

Qty (3)





5.5mm DC power jack
socket.

Qty (1).



KCD1 SPST rocker switch.

Qty (1).



40mm 24vdc brushless
cooling fan.

Qty (1).



3 Position Double Row
Terminal Block.

Qty (1).



Teensy 4.1 (with pins)
Qty (1).



Terminal Block Breakout
Board Module - Teensy 4.1
Qty (1).

GX16-4 aviation plug.

Qty (1).



PBS-110 push button switch

Qty (1).



3D Printed Components

You will need to 3D print the robots covers and spacers. See downloads page <https://www.anninrobotics.com/downloads> for .stl print files. Covers and spacers can be printed in any color of your choosing – in this robot build I have chosen orange covers and black logos.

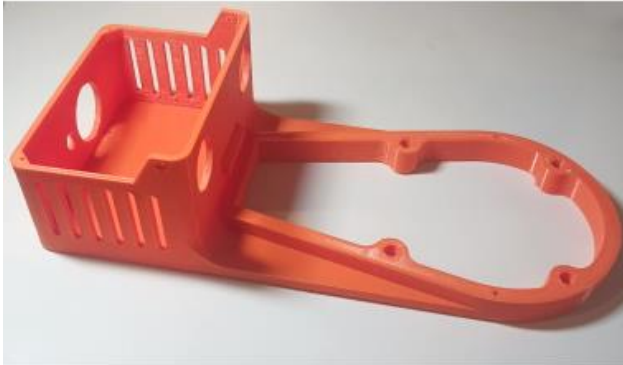

J1 BASE ENCLOSURE

Please note: if you don't have a large bed printer this part is available to print in 2 pieces – see the folder *"Large Parts Split for Smaller 3D printer"*



J1 BASE ENCLOSURE FAN COVER



J1 BASE ENCLOSURE TRAY



J1 ENCLOSURE LID

(Please also see the BOM in chapter 3 for the Modbus PLC option – if you plan on using this option there is an alternate enclosure lid)





J2 SIDE COVER

Please note: if you don't have a large bed printer this part is available to print in 2 pieces – see the folder ["Large Parts Split for Smaller 3D printer"](#)



J2 ARM COVER SPACER

Please note: if you don't have a large bed printer this part is available to print in 2 pieces – see the folder ["Large Parts Split for Smaller 3D printer"](#)



J5 SIDE PLATE

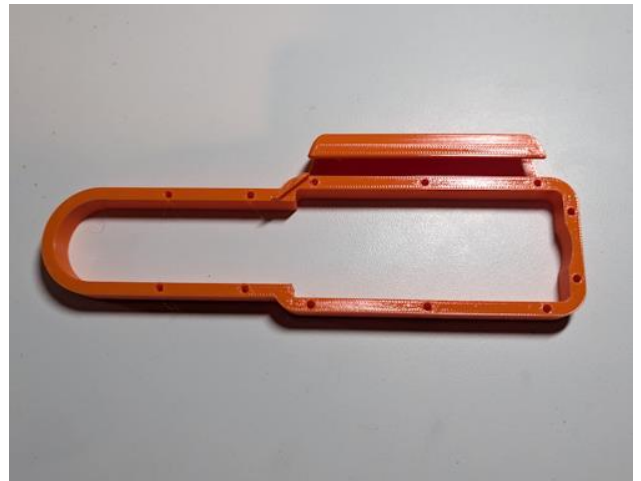

J5 SIDE SPACER





J5 SIDE COVER



J2 & J5 ARM COVER LOGOS



J2 Stop

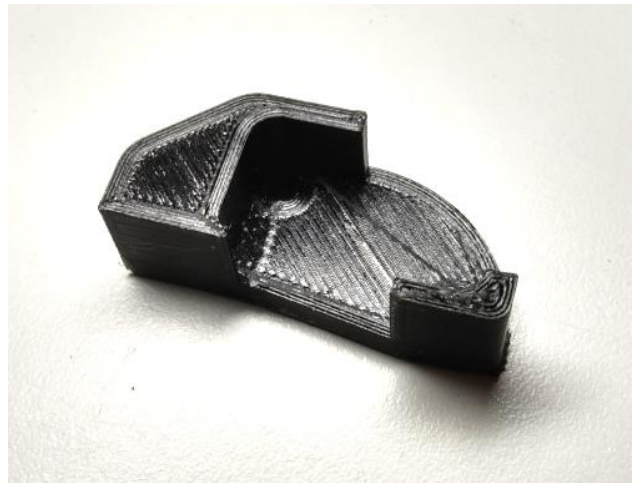

J3 Stop





J2 SPACER PART 1 & 2

NOTE: Robot kits sold prior to 12/4/25 used a single piece spacer (see file named single piece).

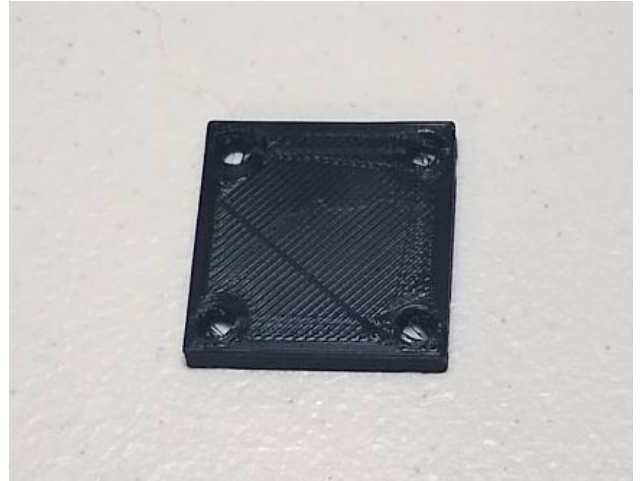

J4 MOTOR SPACER – 4mm



J5 Bearing Post Spacer



J4 Timing Hub



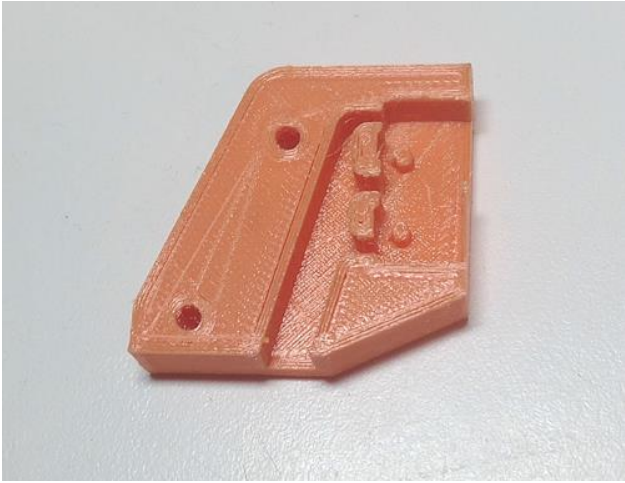

J4 Limit Switch Mount



J5 Motor bracket



J6 Limit Contact



J6 Limit Switch Mount





CF Cat6 Jacket Stripper

This is a tool you can print to assist in removing the outer jacket of the continuous flex Cat6 cable.



J5 Carrier Bump Stop



J5 Main Bearing Arm Plug



Stepper Motors & Drivers

All motors are available from Stepperonline. There is a link on the robot kits page to a complete discounted motor, driver and power supply kit from Stepperonline.

<https://www.omc-stepperonline.com/>



J1 gear head motor

SKU: 17HS15-1684D-EG10-AR4

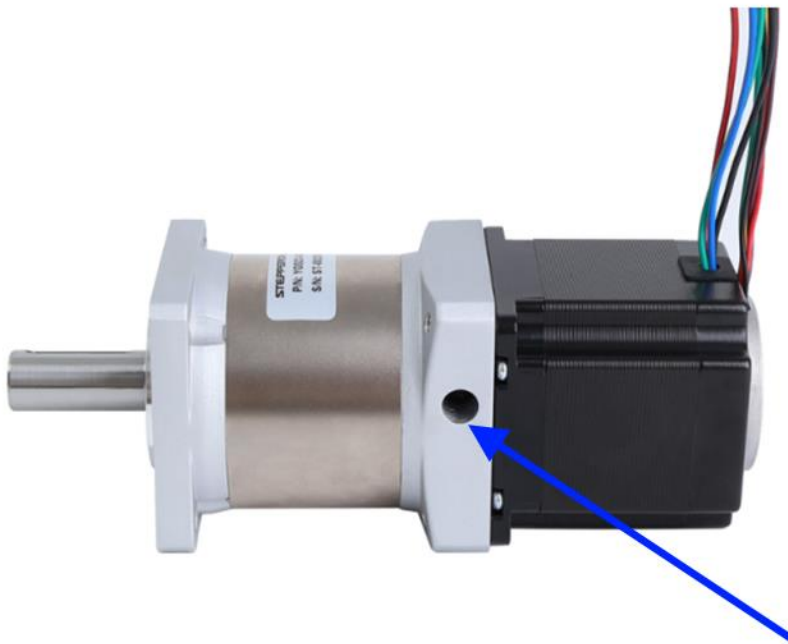

J2 gear head motor

SKU: 23HS22-2804D-YGS50-AR4

NOTE: CHECK AND MAKE SURE THE MOTOR TO GEARBOX COUPLER IS TIGHT. REMOVE THE SMALL PLASTIC PLUG ON THE SIDE OF THE GEARBOX AND USE A HEX KEY WRENCH TO MAKE SURE THE COUPLER INSIDE IS TIGHT.





J3 gear head motor
SKU: 17HS15-1684D-
EG50-AR4

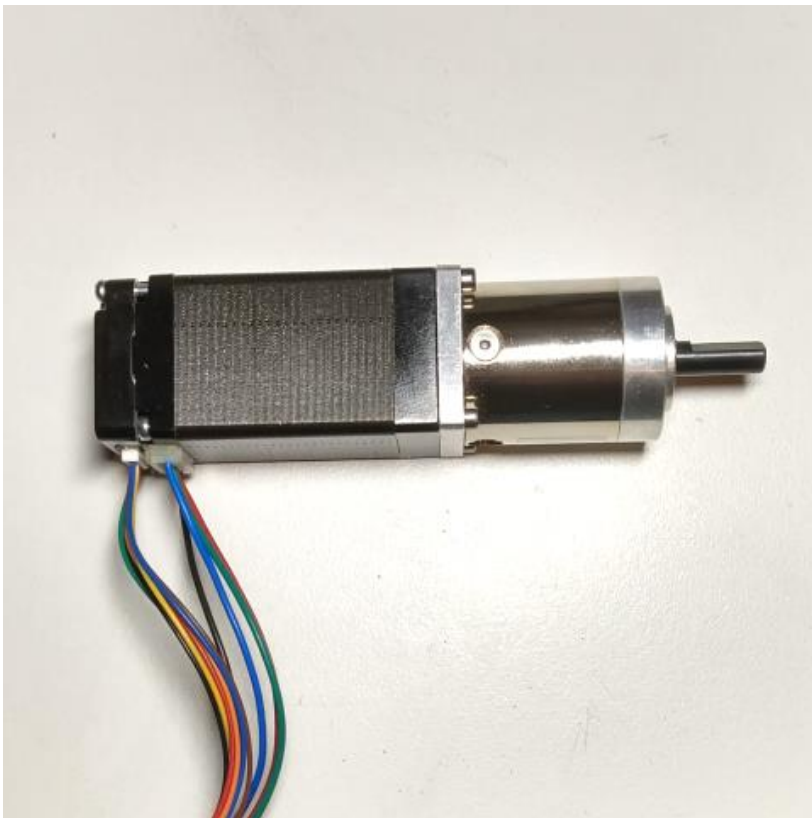

J4 gear head motor
SKU: 11HS20-0674D-
EGS16-AR4

J5 linear drive motor
17LS19-1684E-200G-AR4

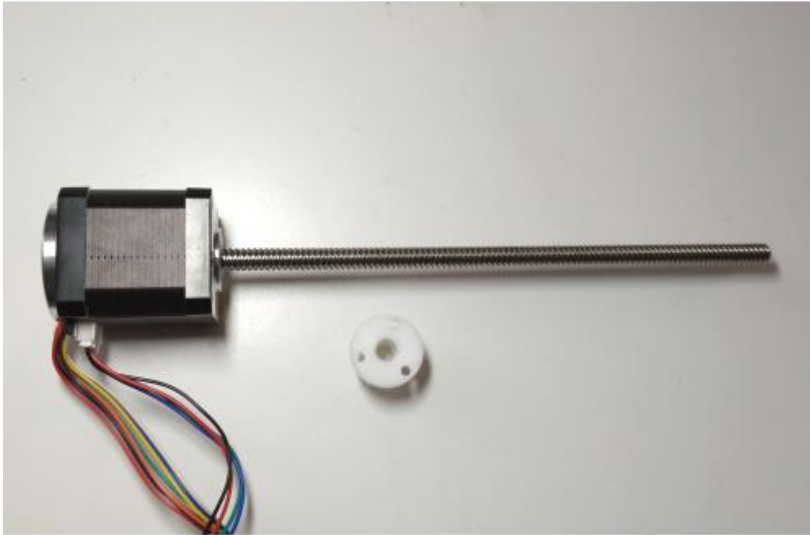

Note: the motor lead screw comes with a POM nut which can be black or white depending on production.

Make sure to remove POM nut from lead screw prior to assembly.



J6 gear head motor
SKU:14HS11-1004D-EGS20-AR4

NOTE: MAKE SURE TO REMOVE GEARBOX DECAL AND ALL RESIDUE BEFORE INSTALLING MOTOR

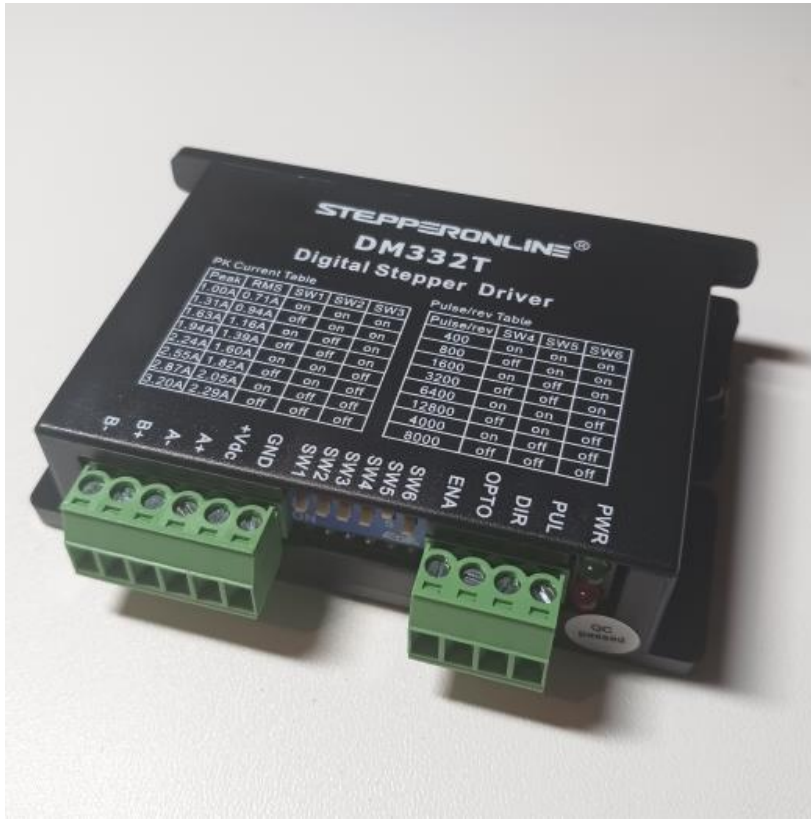

DM332T digital stepper driver.

You will need (3) of these drivers for axis 1,2,3, of the robot.

Drivers and motors are available factory direct from Stepperonline. (see link on robot kits page).

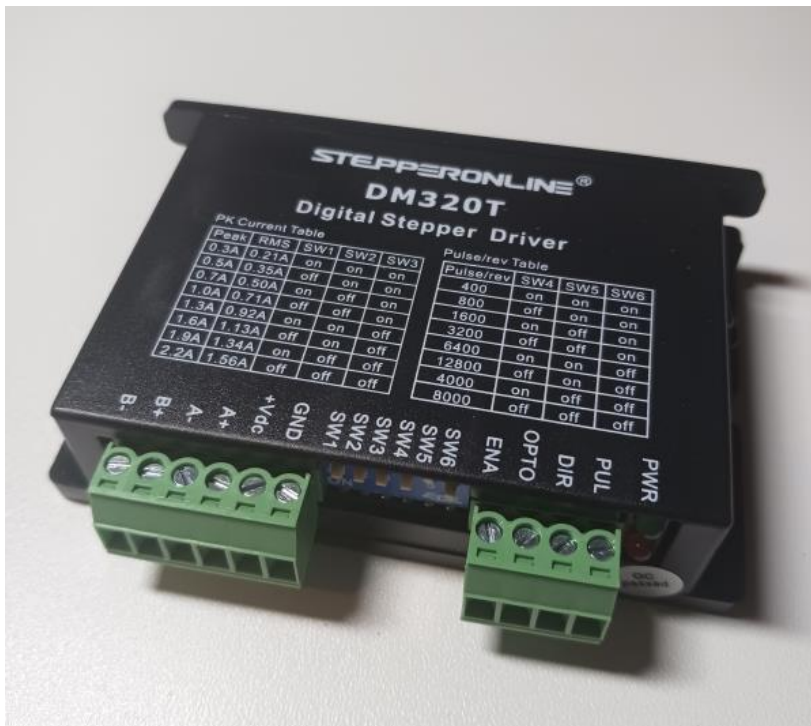

DM320T digital stepper driver.

You will need (3) of these drivers for axis 4,5,6, of the robot.

Drivers and motors are available factory direct from Stepperonline. (see link on robot kits page).



**Nema 11 Bracket for Stepper Motor
Steel Bracket**

★★★★★ 0 reviews | Write a review

SKU: ST-M3

\$1.96

(1) Bracket for the J4 motor

#SKU: ST-M3

CHAPTER 2

ROBOT ASSEMBLY INSTRUCTIONS



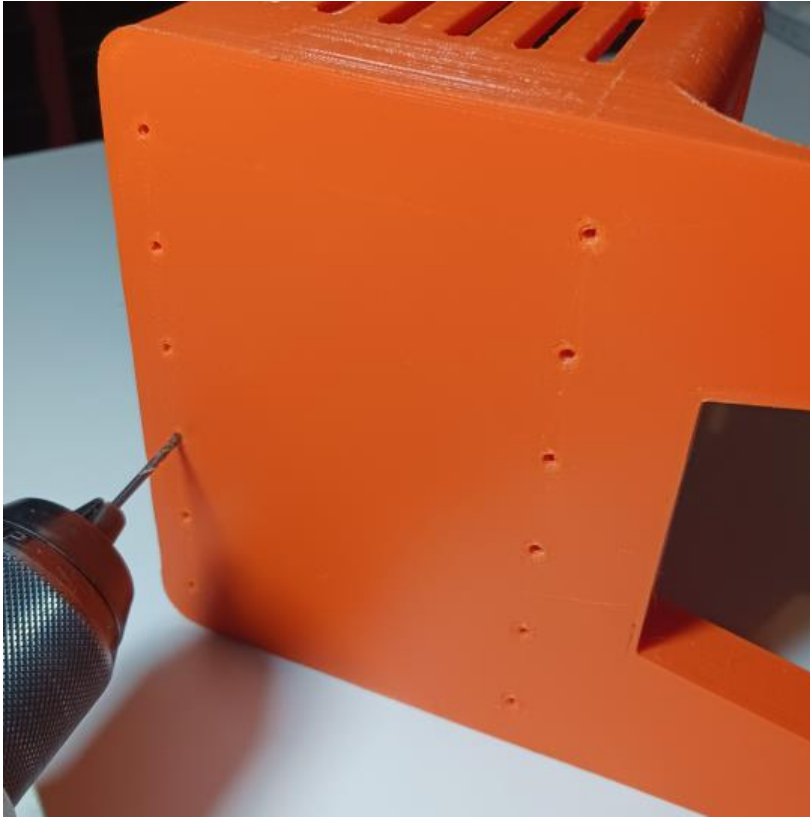

Carefully remove all build structure from the J1 BASE ENCLOSURE. Use 2mm or 0.080" drill to clear or clean out the (6) holes in the bottom of the enclosure.

Please note: if you don't have a large bed printer this part is available to print in 2 pieces that can be epoxied together – see the folder ["Large Parts Split for Smaller 3D printer"](#)

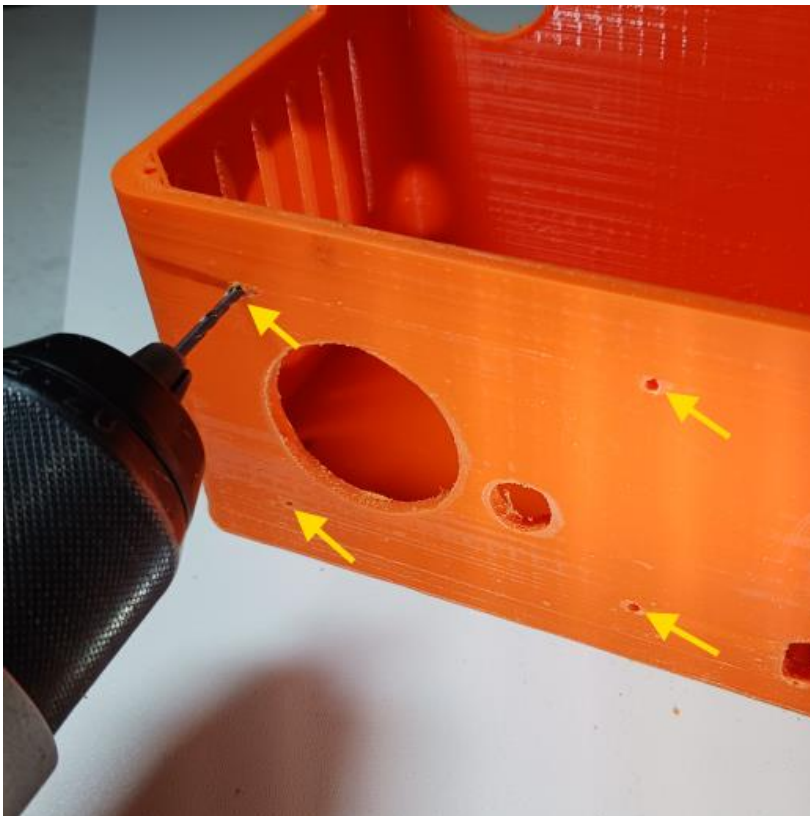

Use 2mm or 0.080" drill to clear or clean out the (4) holes on the rear side of the enclosure (yellow arrows).



Remove 3D print build structure from counterbore holes on both sides of base enclosure, and the clean or clear center of hole with 3.5mm or .140" drill.



Partially screw in (6) of the #6 thread form screws as shown. Only screw them in a couple threads for now.



Place #6 thread form screw in to the left side slot of the DM332T driver as shown and then lower the drive into position.

NOTE: The screw can be held in position with Phillips head screw driver as its lowered down into position.

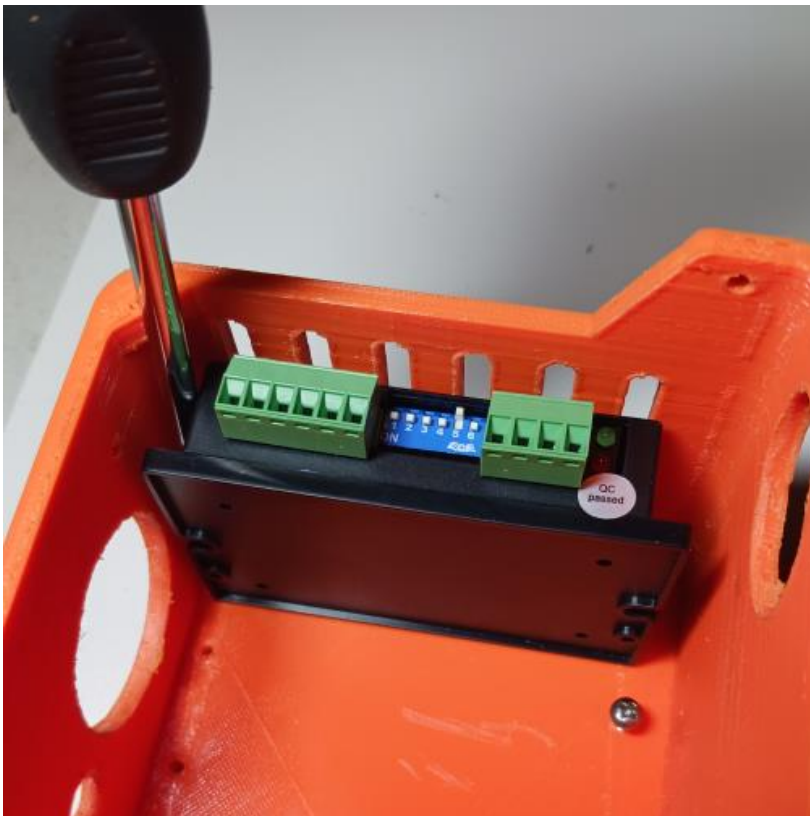

Use Phillips head screw driver to snug the left side screw as the driver is maneuvered into position.

Then snug the screw on the right side of the DM332T driver.

NOTE: be careful not to overtighten screws.

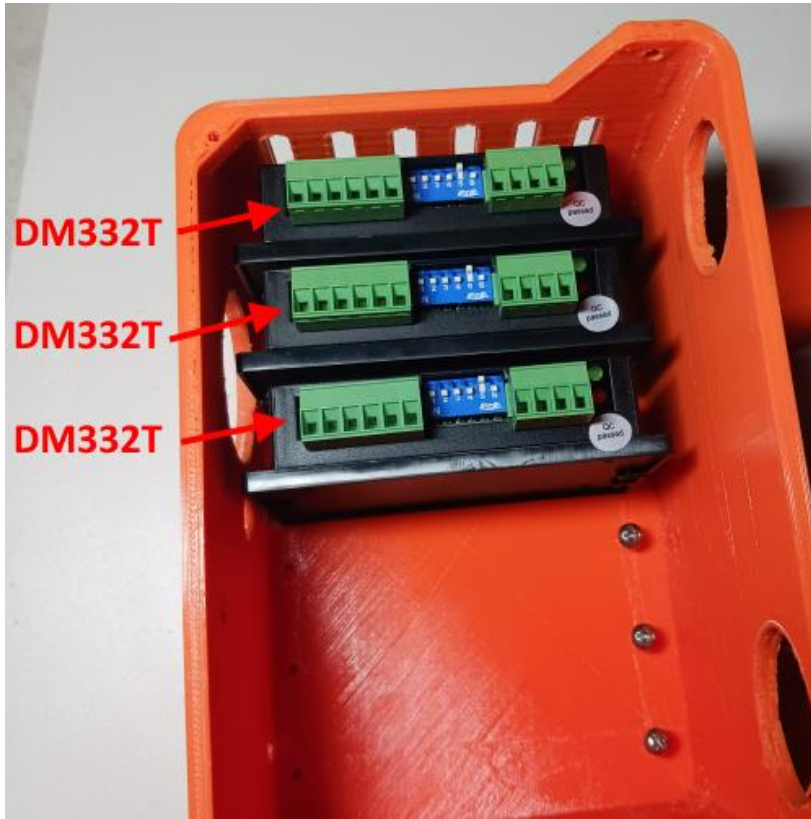

Repeat this process for the remaining (2) DM332T drivers as shown.

NOTE: The (3) DM332T drivers should be installed on the left side of the enclosure as shown in the photo.

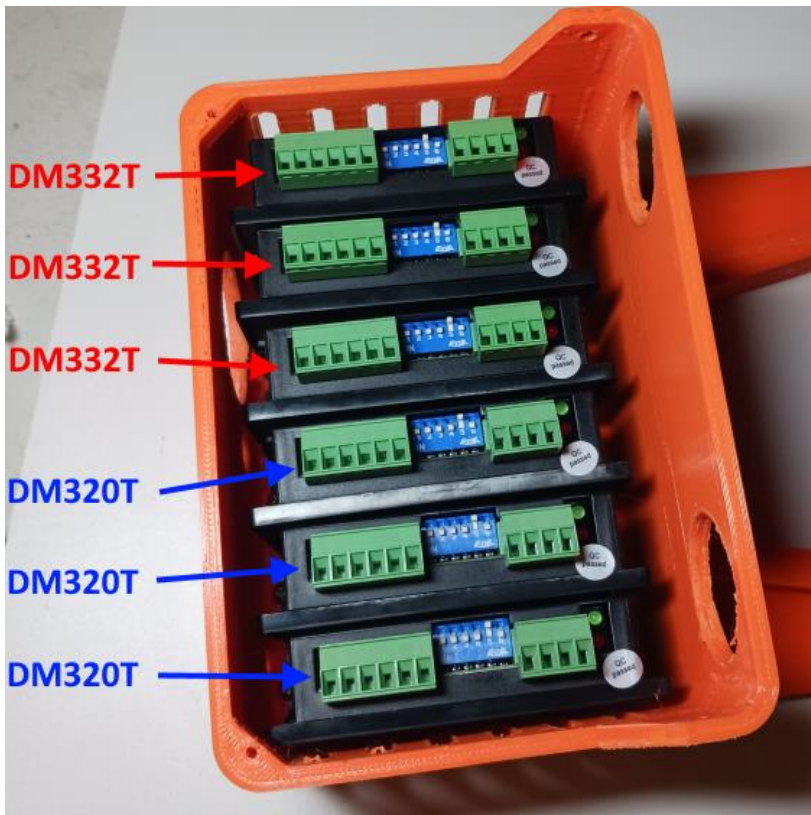

Repeat the driver installation process for the (3) DM320T drivers as shown.

NOTE: The (3) DM320T drivers should be installed on the right side of the enclosure as shown in the photo.

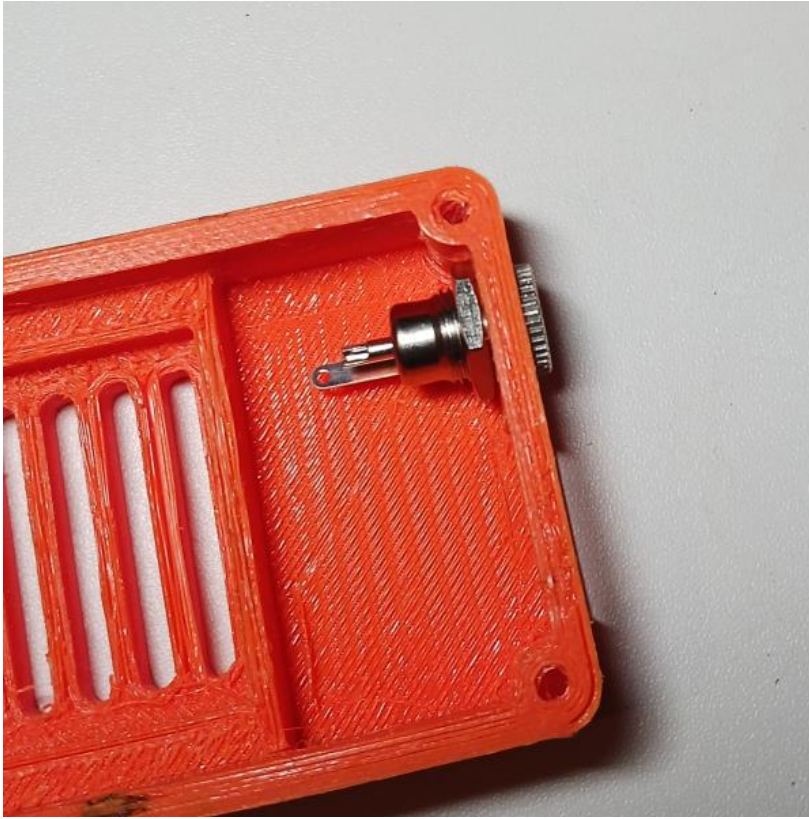

Remove all build structure from 3D printed Base Enclosure Fan Cover then install the 5.5mm power jack as shown.

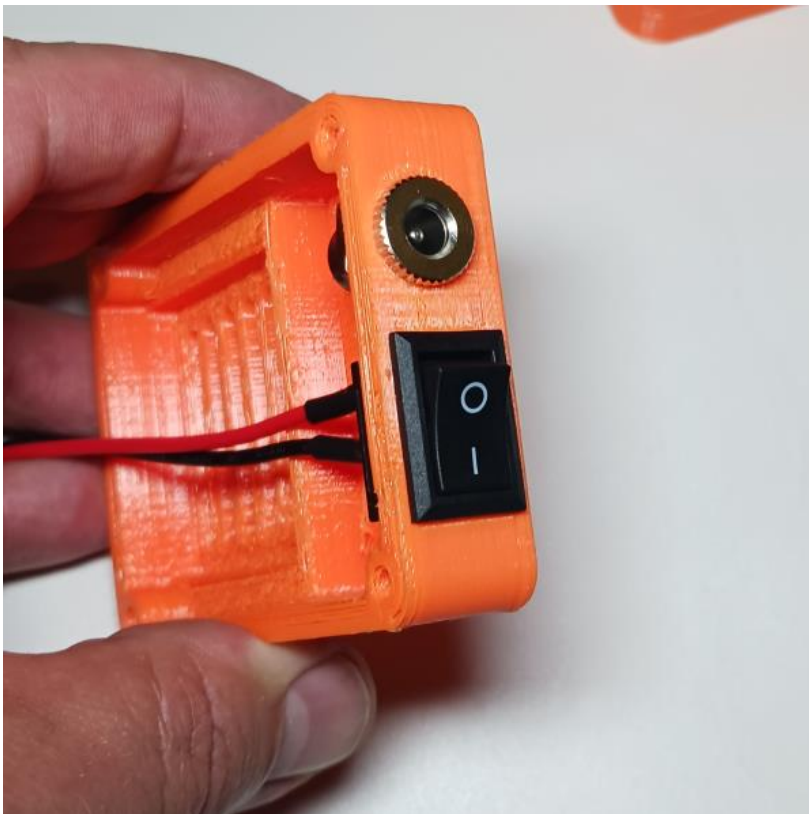

Install rocker switch as shown. Rocker switch will snap into position.

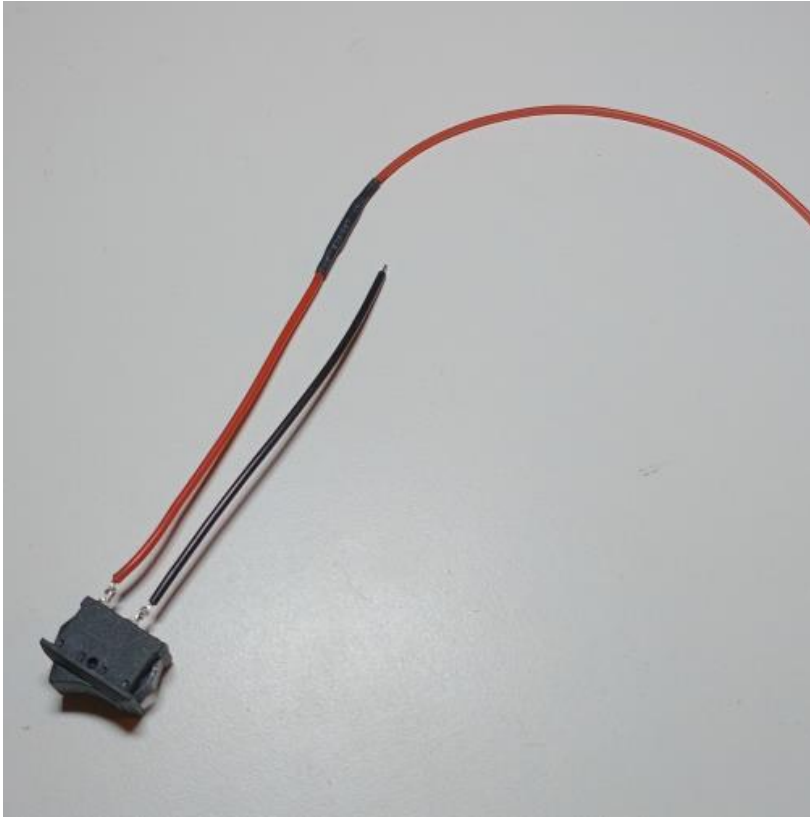

THIS STEP IS ONLY NEEDED IF YOUR ROCKER SWITCH WIRES ARE SHORTER THAN 22 CM LONG.

Given supply chain issues and which supplier I can get parts from sometimes the rocker switch comes with shorter wires.

If they are short please solder and heat shrink (13cm) red wire to extend the rocker switch red wire so that the total length of the red wire is 22cm long.



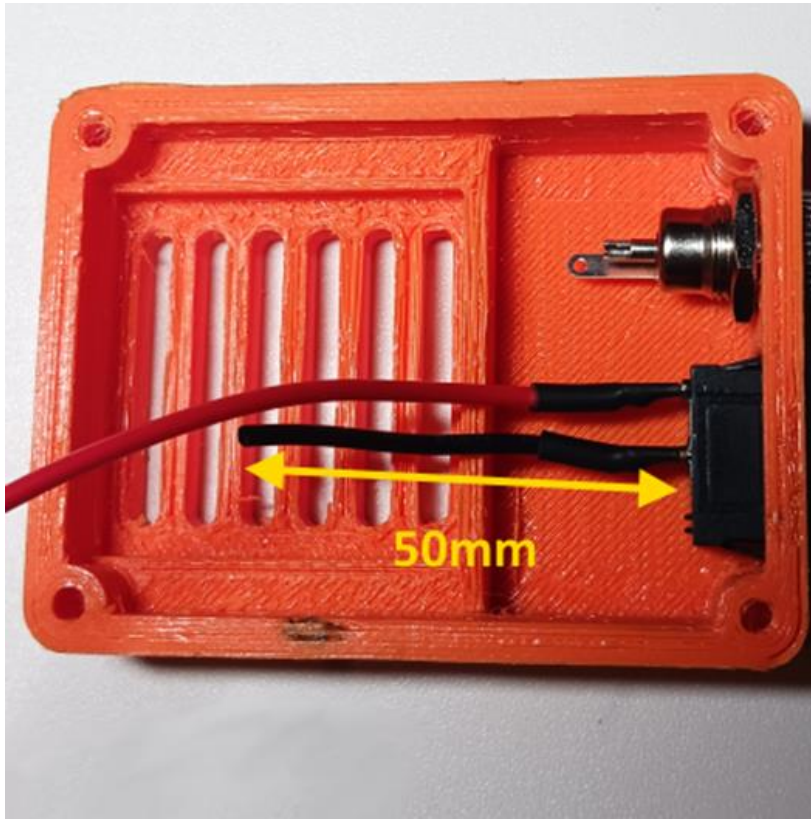

Cut the rocker switch black wire as shown leaving 50mm of wire extended from the rocker switch.

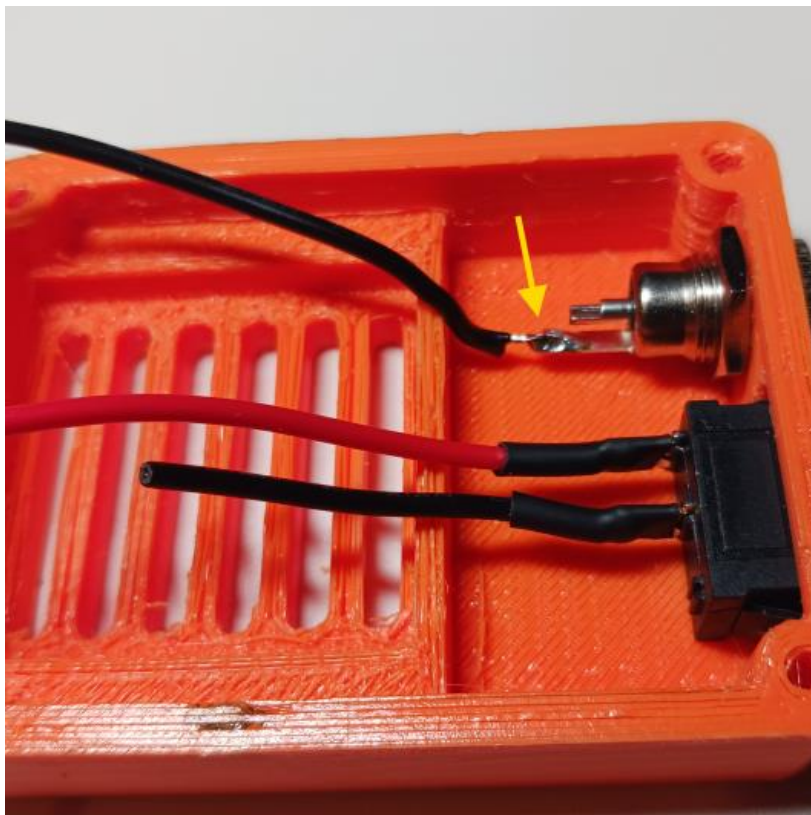

Strip 3mm of sheathing from the end of the black 13cm long 20awg wire and then solder the wire to the 5.5mm power sockets ground connection tab as shown.

NOTE: The ground connection tab is the longer tab coming from the socket outer housing as shown.

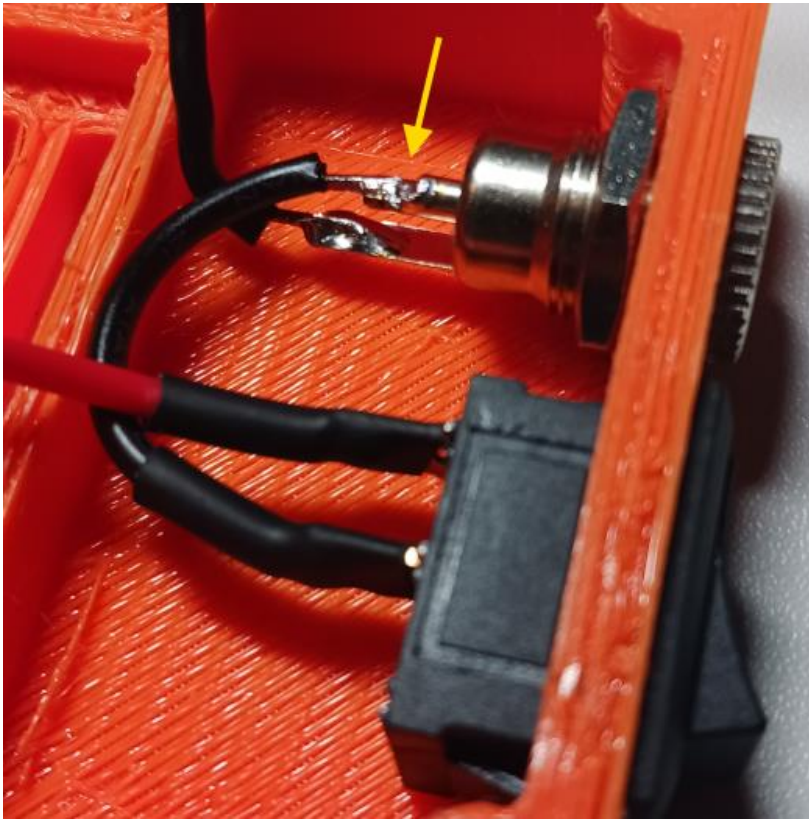

Remove 3mm of sheathing from the rocker switch black wire and then solder the rocker switch black wire to the positive center terminal on the 5.5mm power jack as shown.

NOTE: the positive terminal is the one in the center of the power jack. Make sure solder connections to each of the power jack terminals are solid and that there are no stray strands of wire and that there are no possibilities of a short between the power jack terminals.

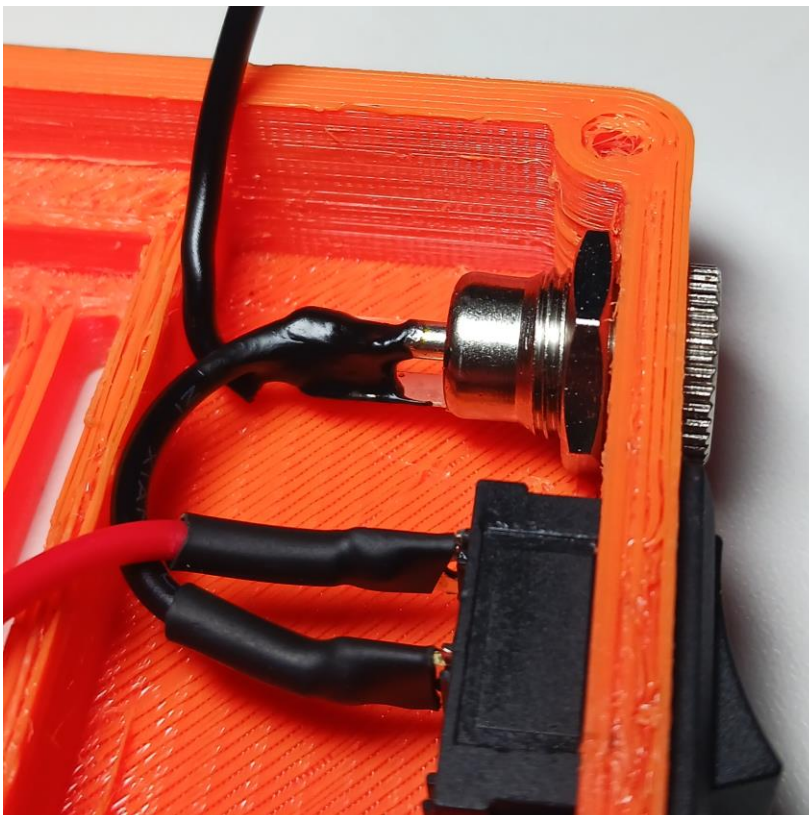

Apply liquid electrical tape to the power jack terminals ensuring there is no possibility of a short between the power jack terminals.

NOTE: allow liquid electrical tape to dry and harden completely before moving to the next step.



Insert 40mm cooling fan into housing as shown. The fan label should be facing out.

NOTE: The fan is a snug slip fit into housing and is not secured with any fasteners.

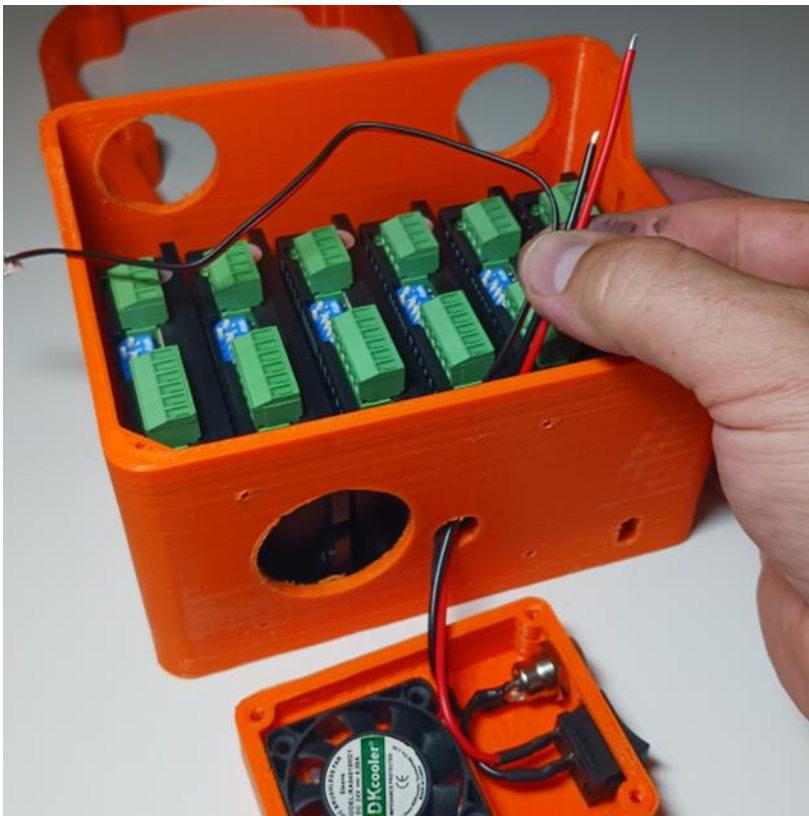

Feed the red and black power wires as well as the cooling fan wires through the base enclosure access hole as shown.



Secure fan enclosure to the base enclosure as shown using (4) #6 plastic thread form screws.

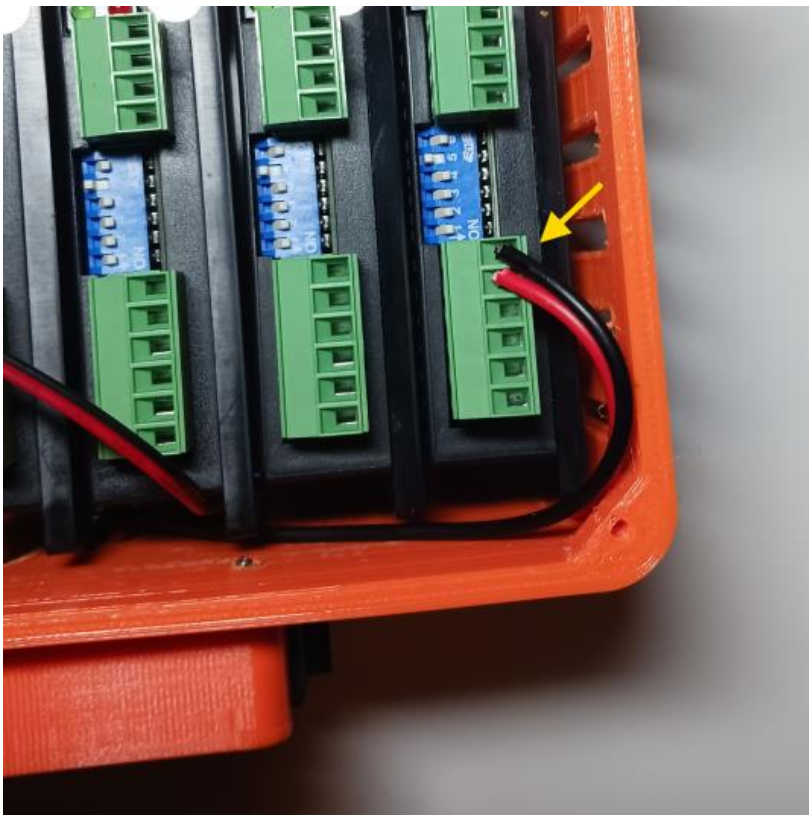

Connect the red power wire to the +Vdc terminal on the far right driver.

Connect the black power wire to the GND terminal on the far right driver.

NOTE: the green connection socket to the driver will need to be pulled out to insert wires and tighten the terminal screws.



Cut (5) pairs of red and black 20awg wires.

The wires should be 48mm in length.

Strip 3mm of sheathing from the ends of each wire.



Use the (5) pairs of wires to jumper the +Vdc and GND circuit across all 6 drivers as shown.

NOTE: the green connection socket to the drivers will need to be pulled out one at a time to insert wires and tighten the terminal screws.

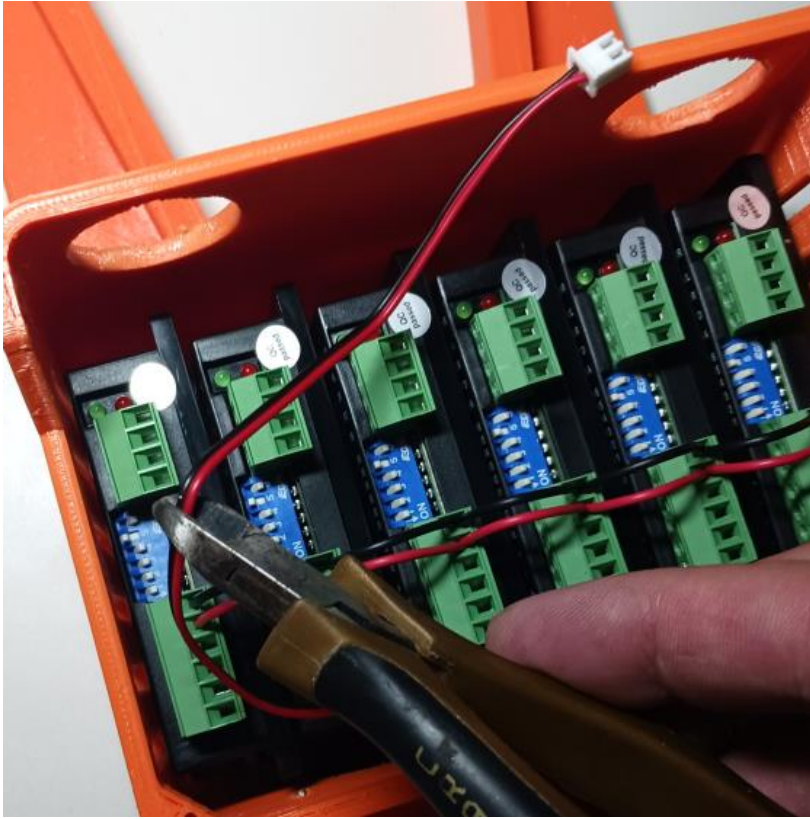

Cut the cooling fan wires as shown.

110mm of cooling fan wires will be removed.

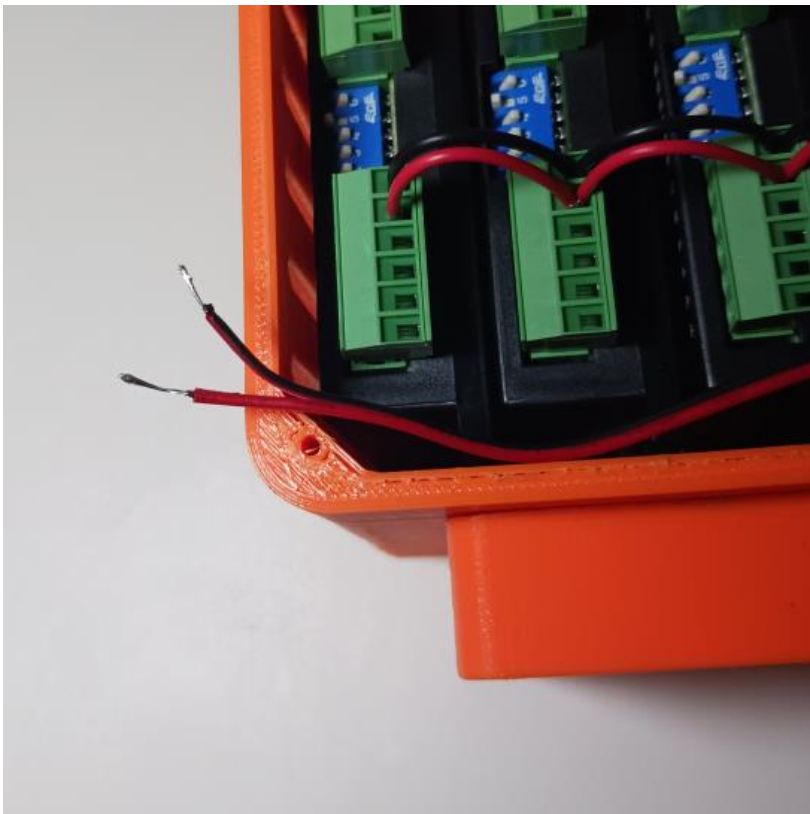

Remove 4mm of sheathing from ends of the cooling fan wires.

The cooling fan wires are very thin. I would suggest "tinning" the wires – apply electrical solder to the ends of the wires to strengthen them.

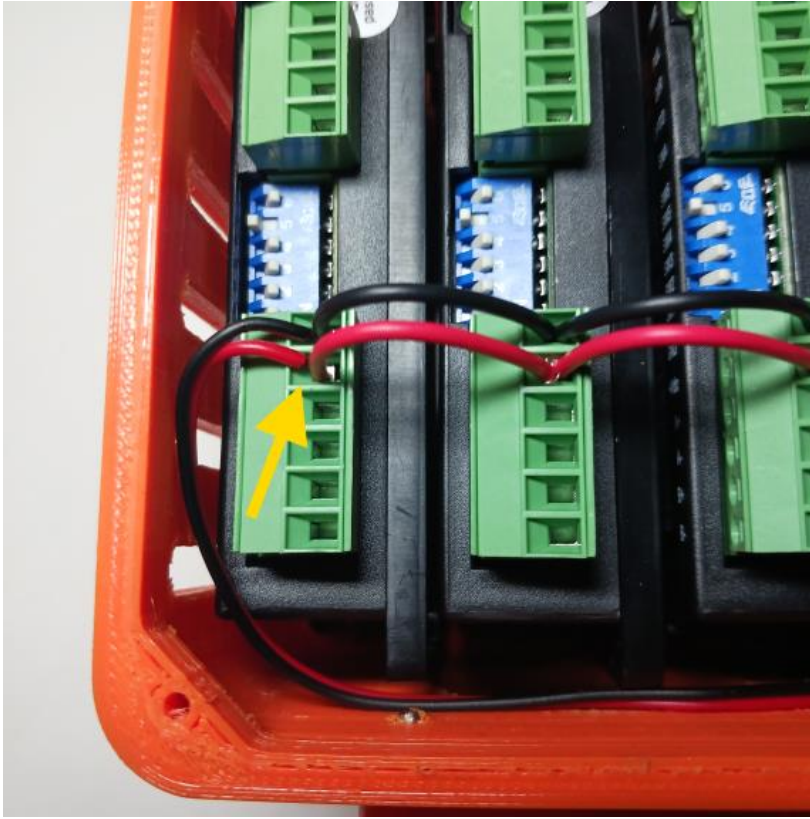

Connect the fan red wire to the far left drivers +Vdc terminal along with the red jumper wire as shown.

Connect the fan black wire to the far left drivers GND terminal along with the black jumper wire as shown.

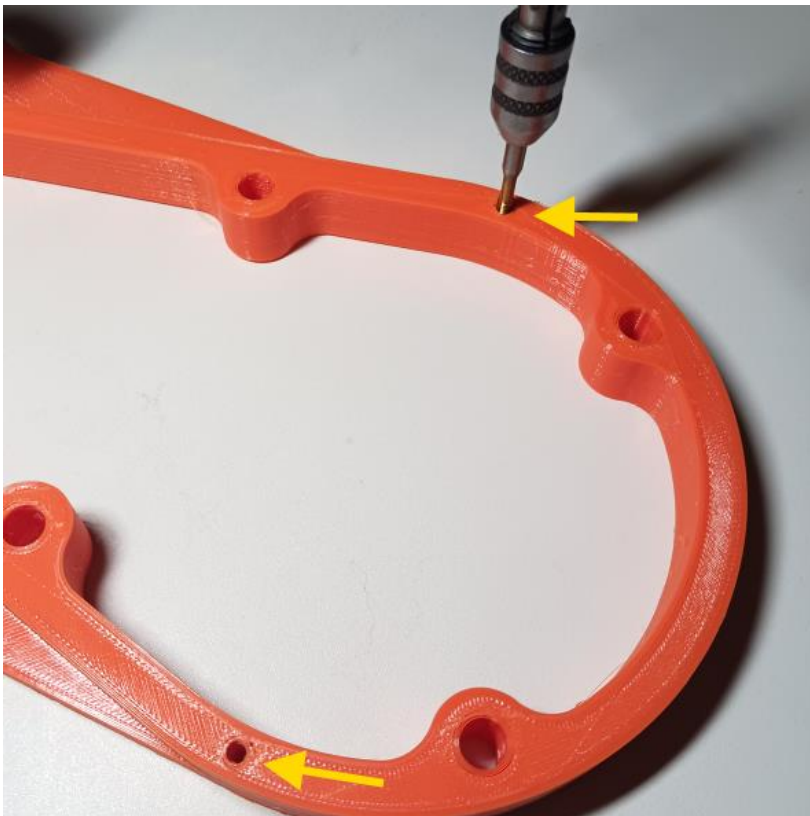

Use M4 tap to thread (2) holes as shown in J1 base enclosure.

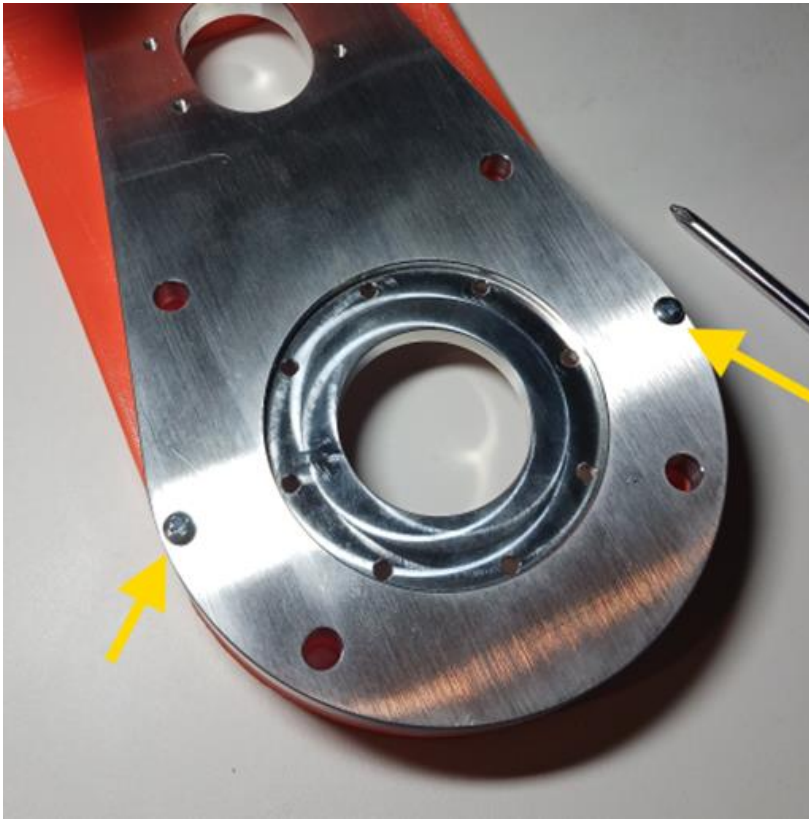

Secure J1 base plate to J1 enclosure assembly using (2) M4x20 pan head machine screws.

NOTE: these screws are meant to hold base plate to enclosure for assembly and transport purposes only – when assembly is complete and you are ready to use your robot you will need to secure robot to table or work surface using 8mm fasteners through (4) mounting holes.

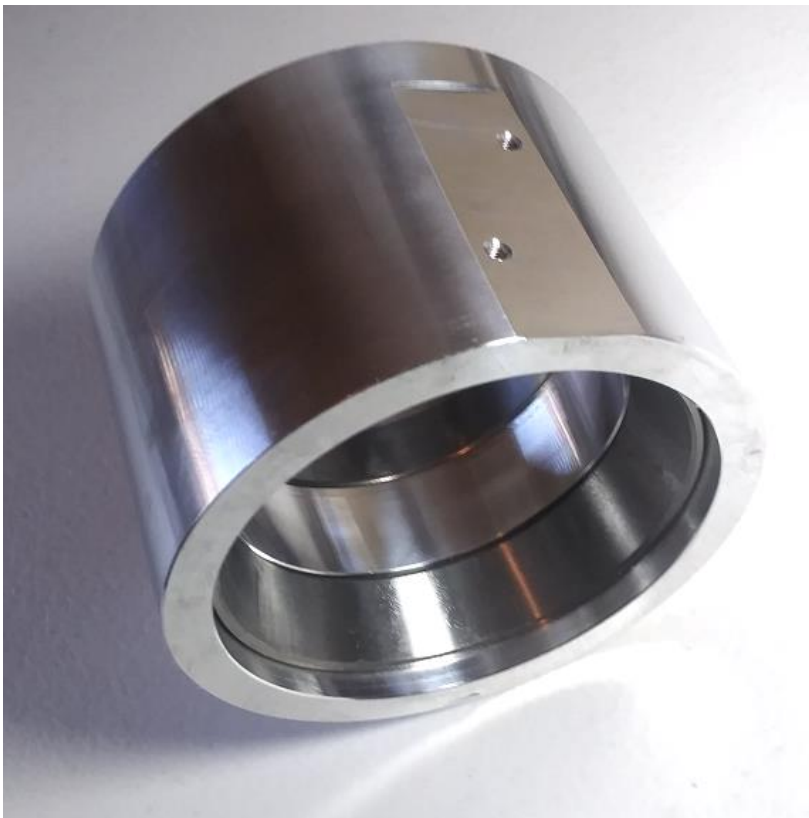

Press (x2) #32009 bearing races into the J1 turret housing. (you will need to do this for both races one at a time)

(See notes on bearing fit in overview section)



Install #32009 bearing on J1 spindle as shown.

(See notes on bearing fit in overview section)



Insert J1 spindle into turret housing then install the other #32009 bearing on top side of spindle.

NOTE: Apply a small amount of bearing grease to bearings prior to assembly.



Install M8 x 10 cap screw into J1 platform as shown.

The head of this is screw will contact the J1 limit switch.

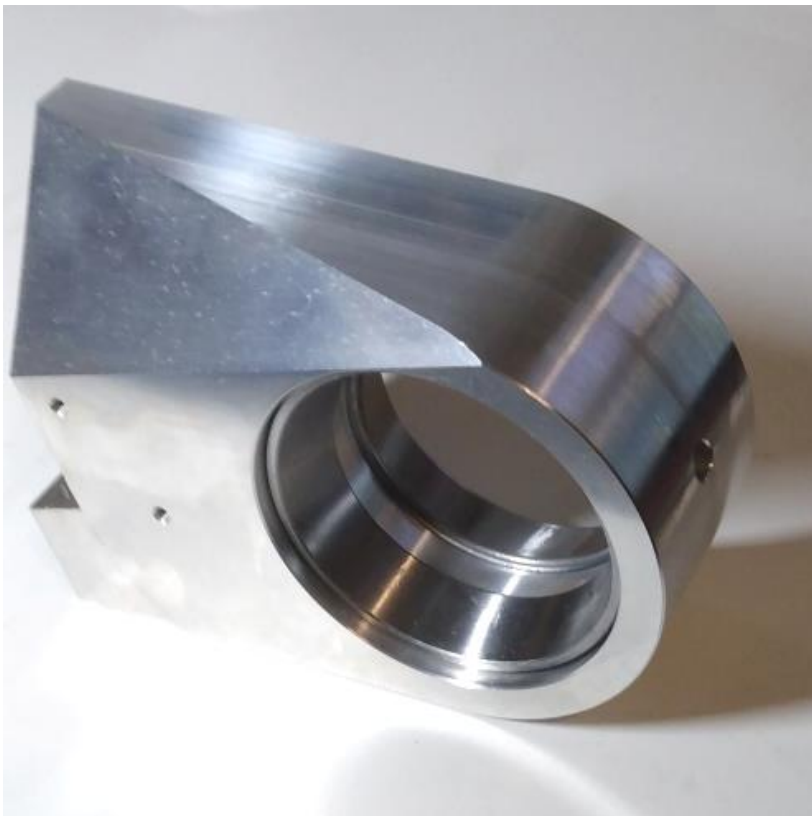

Press (x2) #30206 bearing races into the J2 turret housing. (you will need to do this for both races on each side)

(See notes on bearing fit in overview section)

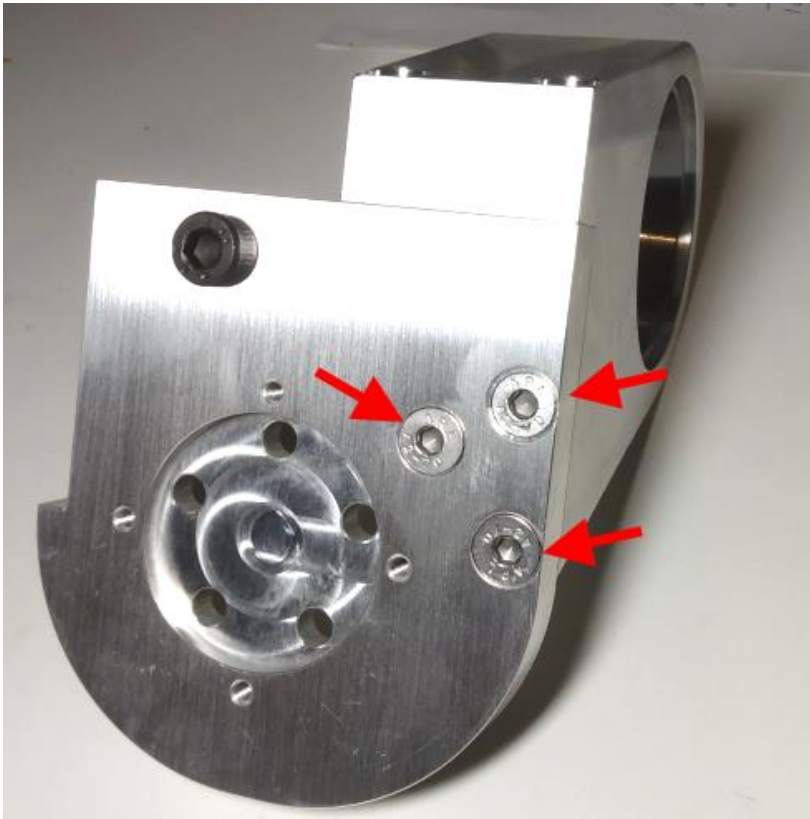

Secure J2 turret housing to J1 platform using (3) M6x18 flat head screws.



Install (2) M6 x 20 socket head screws in front of J2 turret housing going into the J1 platform.



Install platform assembly onto J1 spindle assembly and secure with (5) M6 X 14 socket head cap screws.

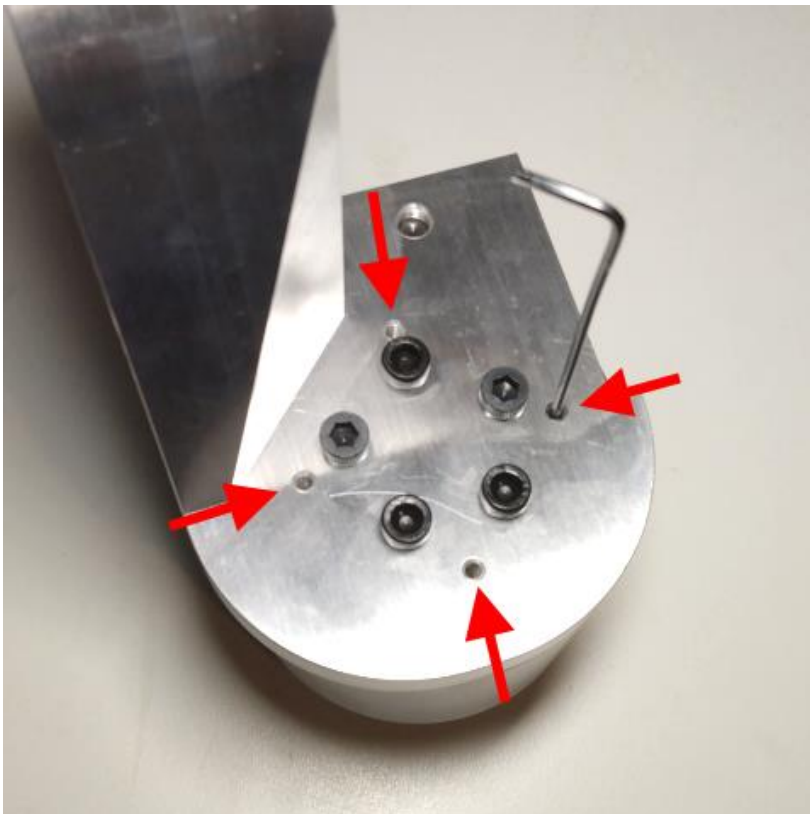

Install (4) M4 x 10 set screws in the 4 perimeter holes in the platform.

These place tension on the upper bearing.

Snug the 4 set screws down evenly until there is no play in the bearings.

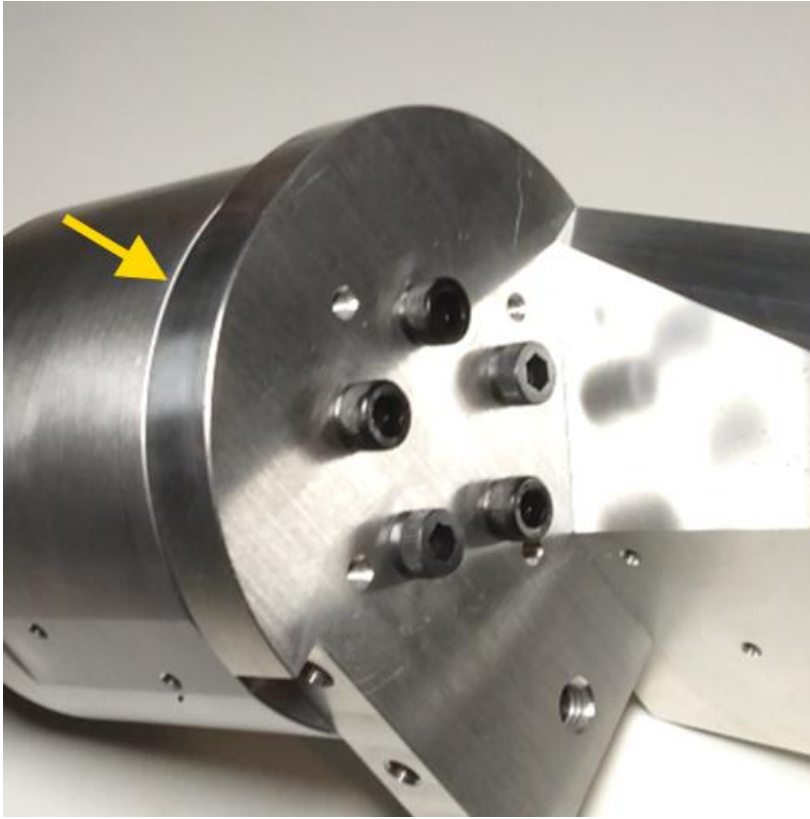

Please note that the J1 spindle and platform should rotate freely.

The gap between the J1 platform and the J2 housing (yellow arrow) is meant to be a tight or thin gap to prevent contaminants from easily getting into the bearing area.

In some cases tolerance stack up can result in some rubbing between platform and housing.



If you experience any rubbing you can remove the J1 platform and install a .1mm shim between the spindle and platform. In the example shown an aluminum circle was cut from the side of an aluminum can that fits concentrically inside the M6 bolt pattern and then reassemble.

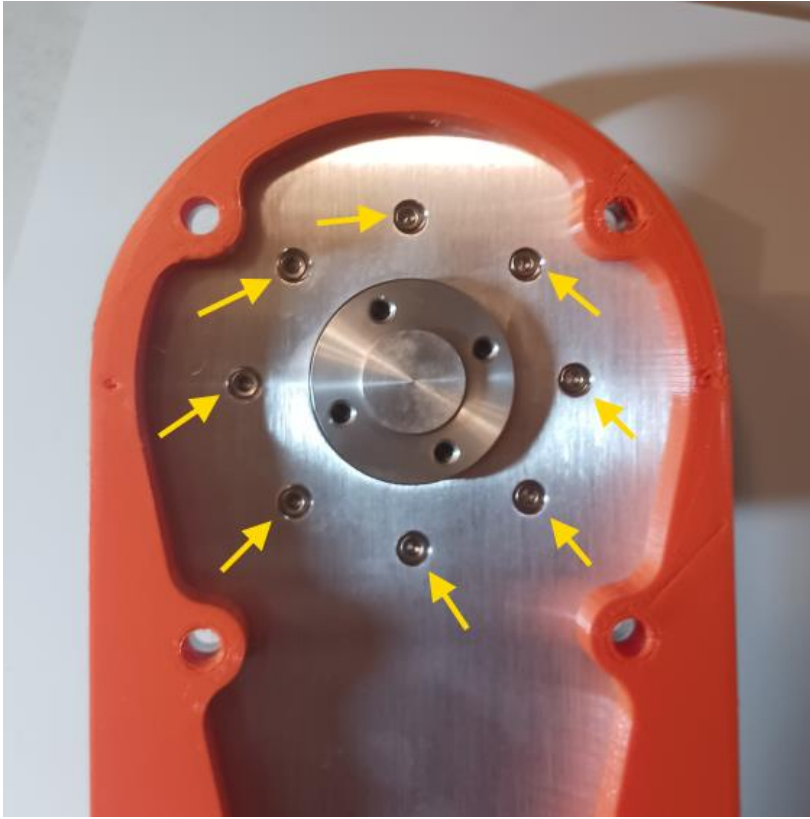

Secure J1 turret assembly to J1 base from the bottom using (8) M4x10 socket head cap screws.

Note orientation of limit switch flat in next step prior to installing.



Make sure limit switch flat is facing toward rear as indicated by red lines in this image.

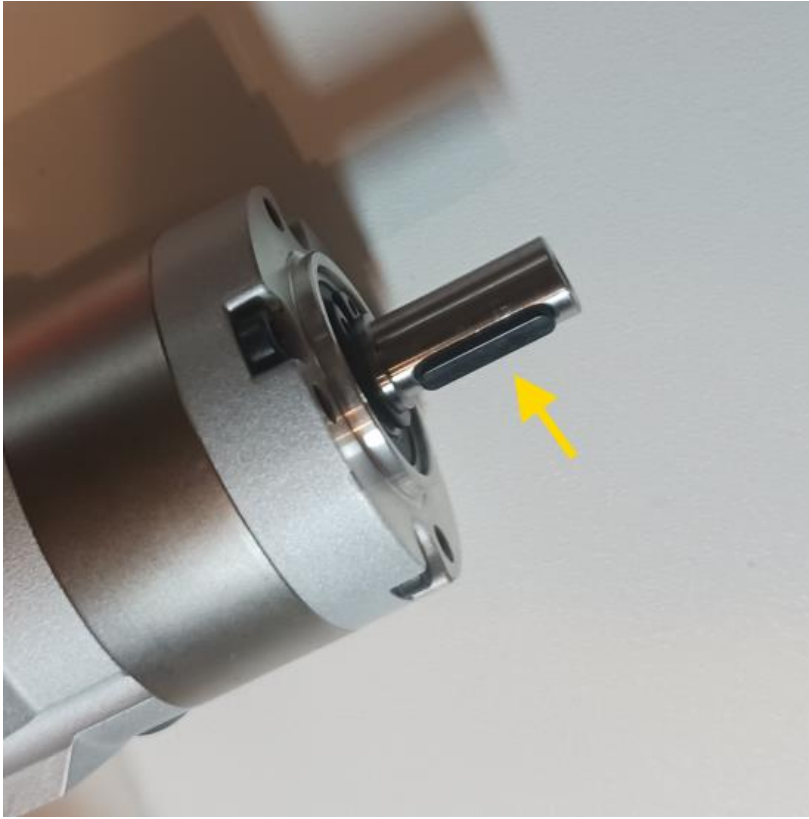

Install 3mm key into J1 (SKU: 17HS15-1684D-EG10-AR4) motor shaft as shown.

The motor keys are shipped from Stepperonline in a small zip bag supplied with the motor paperwork and manuals.



Secure J1 motor mount to J1 motor using (4) M4x10 flat head screws.

Make sure the motor wires are oriented on the right side as shown (yellow arrow) and that the J1 motor mount tension holes are facing toward you (red arrows).

MAKE SURE YOU ARE INSTALLING THE J1 MOTOR AND NOT THE J3 MOTOR. IT HAS BEEN A COMMON MISTAKE GETTING THESE 2 MOTORS SWAPPED AS THEY ARE NEARLY IDENTICAL IN APPEARANCE.

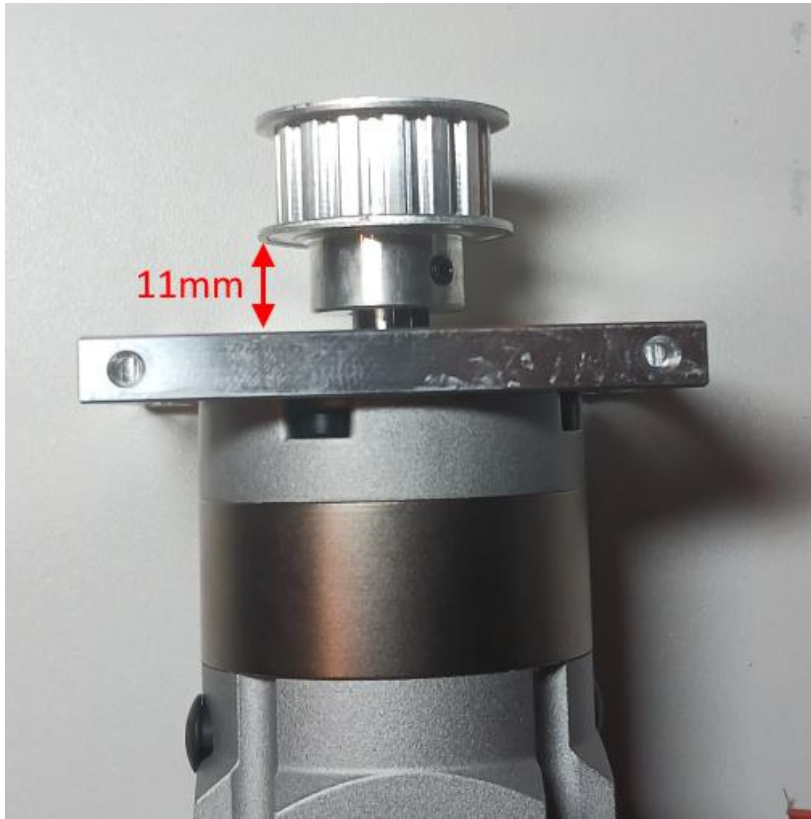

Install XL15 tooth 8mm bore drive sprocket on J1 gear motor shaft, make sure key is aligned in pulley slot and secure with (2) M3x4 set screws.

Make sure the lower flange of pulley is set at a distance of 11mm as indicated by the red arrow.



Install (2) M3x10 set screws in rear of motor mount slots.



Install motor assembly onto base and

secure with (4) M4 X 20 socket head cap screws and (4) washers but do not fully tighten until after belt is tensioned.

NOTE: Make sure (2) 3mm tension holes located on ends of slots are facing toward back (yellow arrow).



Install 60T timing hub pulley onto J1 spindle and secure with (4) M6x14 socket head cap screws, then install 180XL037 belt as shown.



Make sure the (4) 4mm X 20 socket head cap screws securing the motor to the baseplate are slightly loose so that motor can slide to apply belt tension.

Tension J1 belt using (x2) M3x10 set screws in rear of motor mount slots.

NOTE: when belt is at good moderate tension the set screws will be fully threaded into the motor base plate and no longer be visible.



These 2 set screws can be difficult to access, using a pair of needle nose pliers to guide the hex key wrench into position can be very helpful.

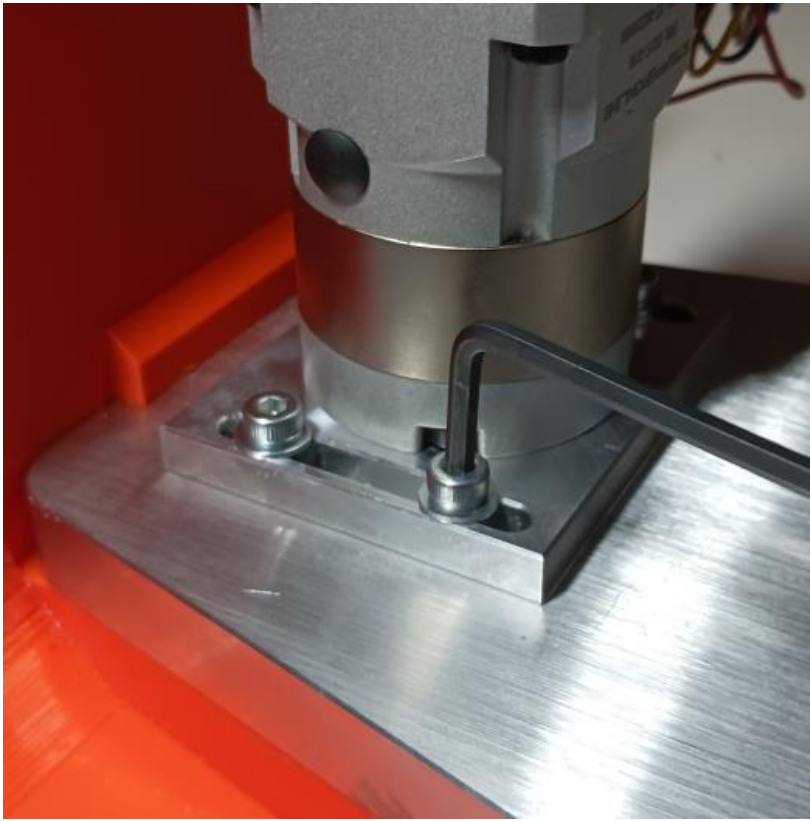

Once belt has moderate tension tighten the (4) 4mm X 20 socket head cap screws securing the motor to the baseplate.

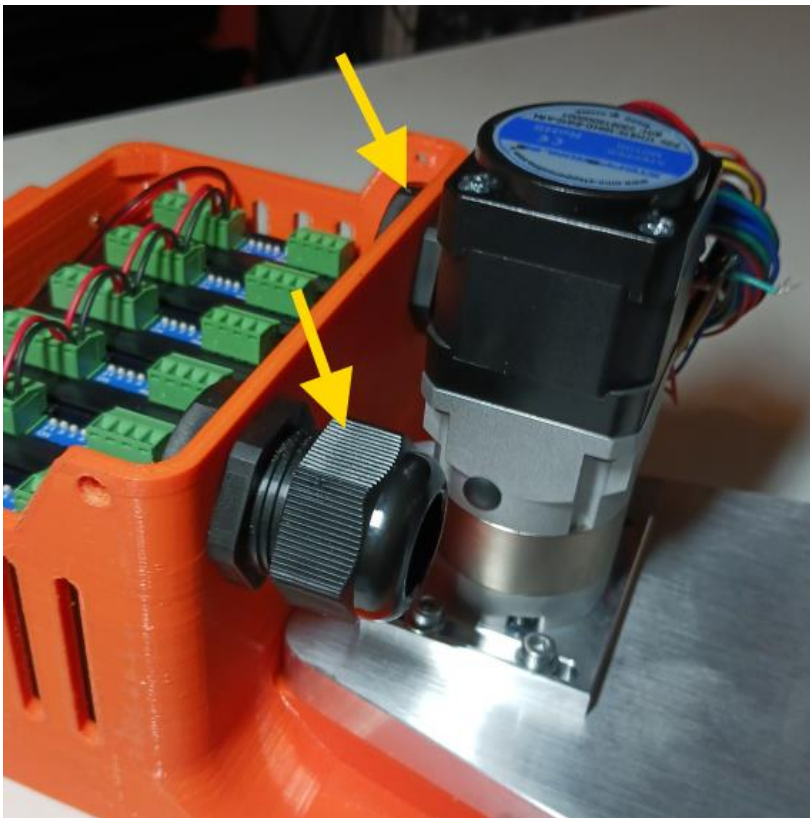

Install (2) PG-21 gland nuts into base enclosure as shown.

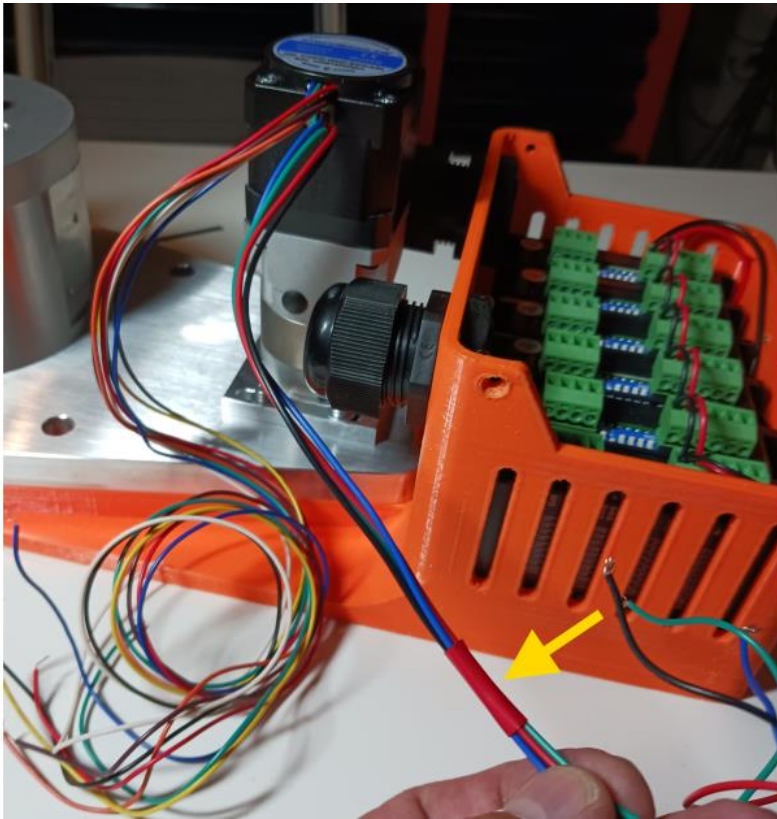

Separate the J1 motor wires from the J1 encoder wires and then wrap a small length of tape around the motor wires. Any tape can be used (I have used red electrical tape).

This tape wrap is simply so that you can identify the motor wires once the wires are pulled into the enclosure.

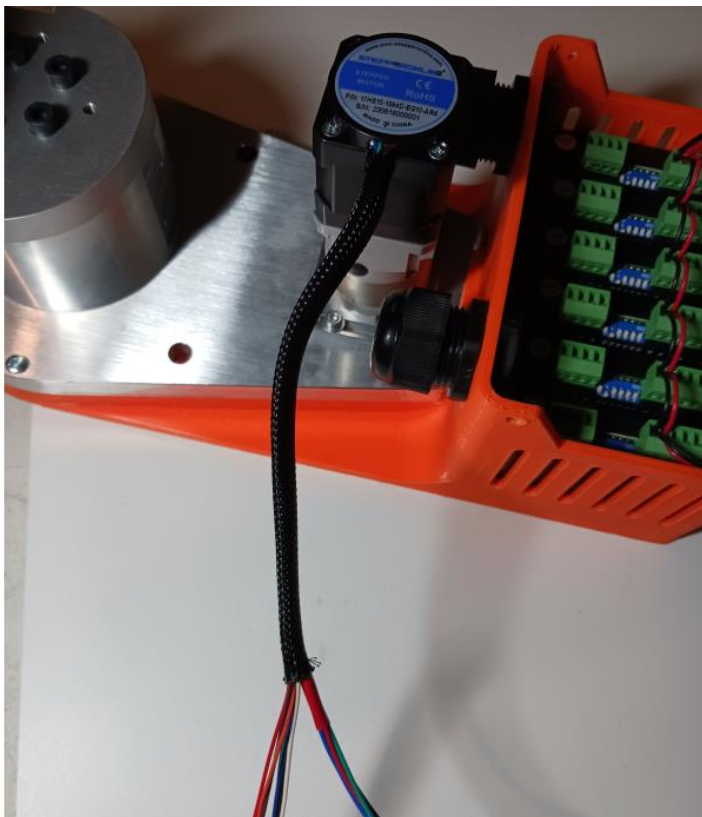

Cut length of $\frac{1}{4}$ " braided sleeve to a length of 16.5cm long then route the J1 motor and encoder wires through the sleeve as shown.

It is recommended to use a lighter to slightly singe the ends of the braided sleeve to prevent the braided sleeve from fraying and becoming unbraided.



Route the J1 wires with braided sleeve into the J1 enclosure as shown.

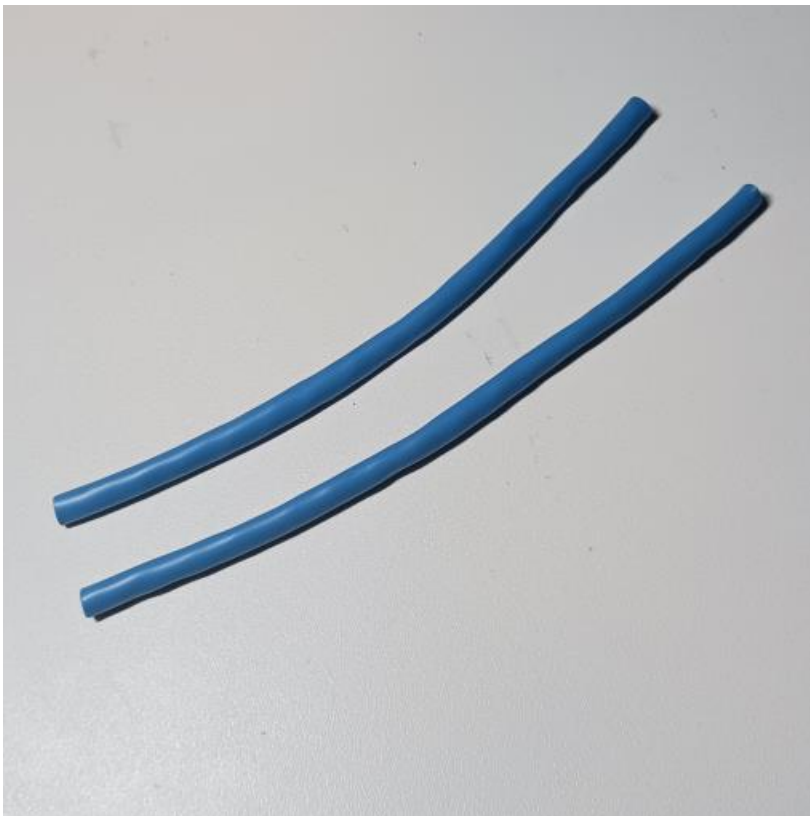

Cut (2) lengths of solid strand Cat5 cable to lengths of 145mm.

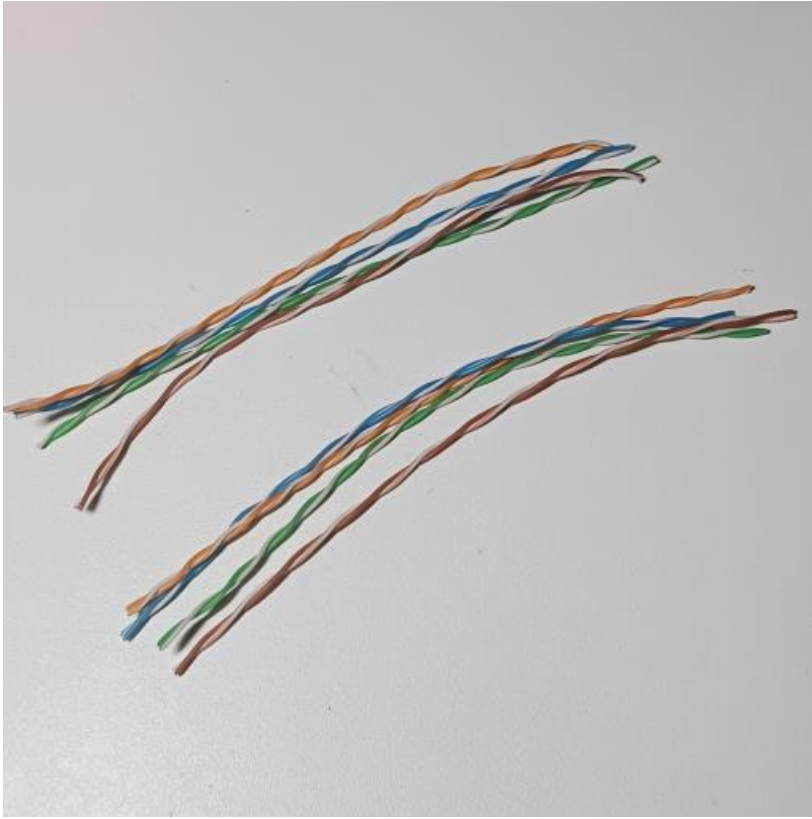

Remove outer sheathing from cable lengths.

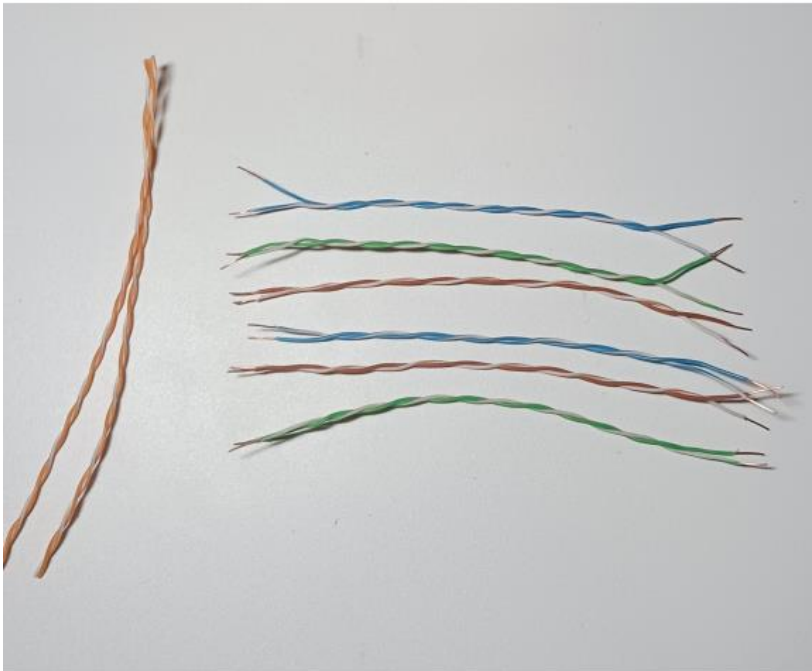

Set the orange pairs of wires aside and then strip the ends of the blue, green and brown pairs of wires.



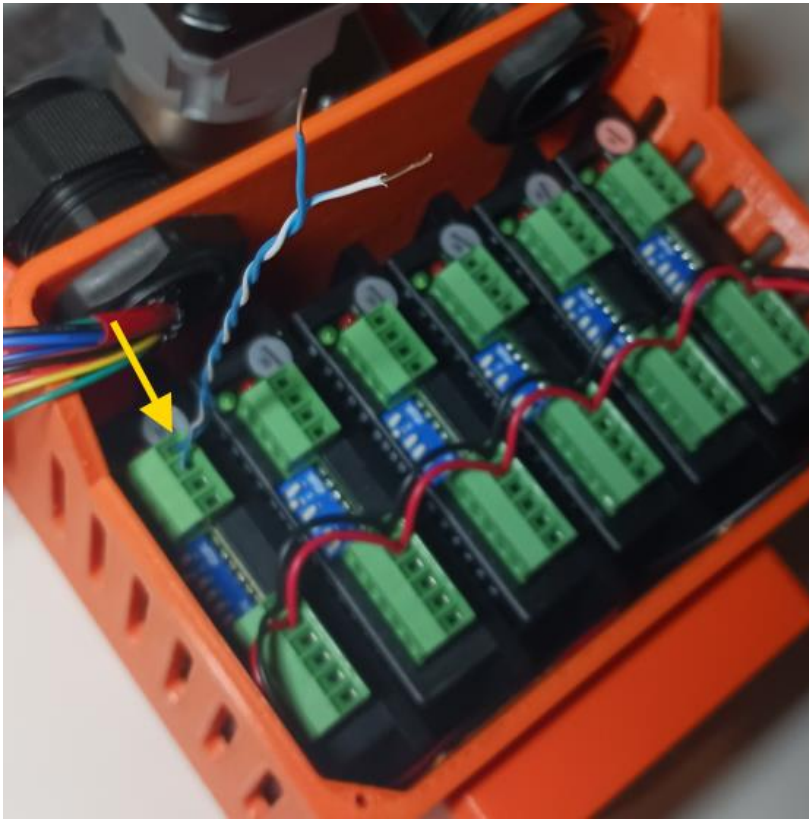

Insert one of the blue pairs of wire into the J1 driver on the far left.

The solid blue wires goes to the “PUL” terminal.

The striped wire goes to the “DIR” terminal.

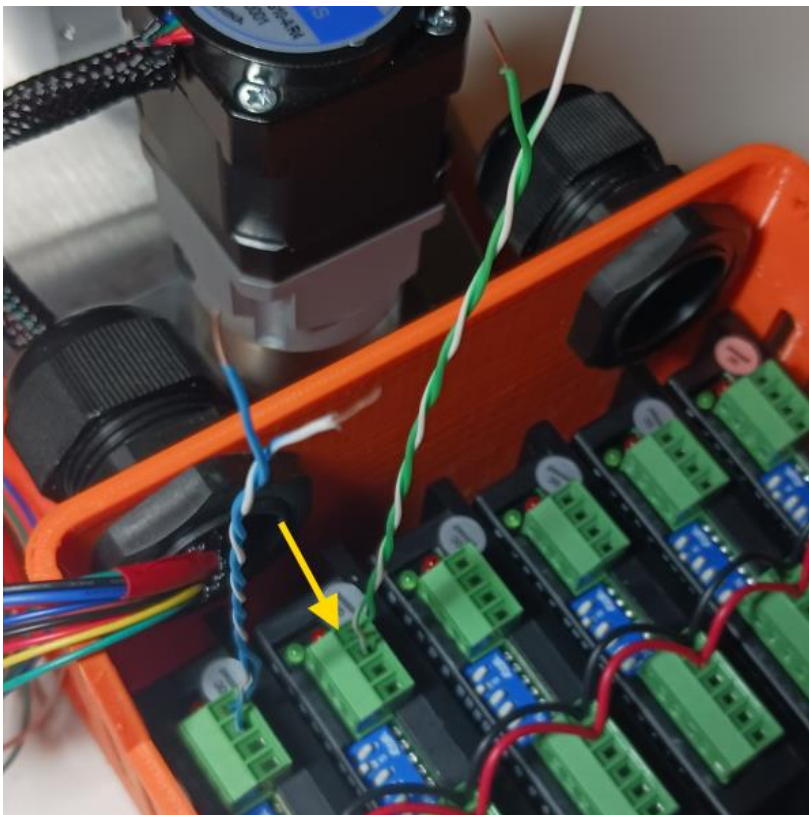
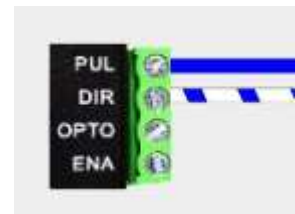

Insert one of the green pairs of wire into the J2 driver as shown.

The solid green wires goes to the “PUL” terminal.

The striped wire goes to the “DIR” terminal.



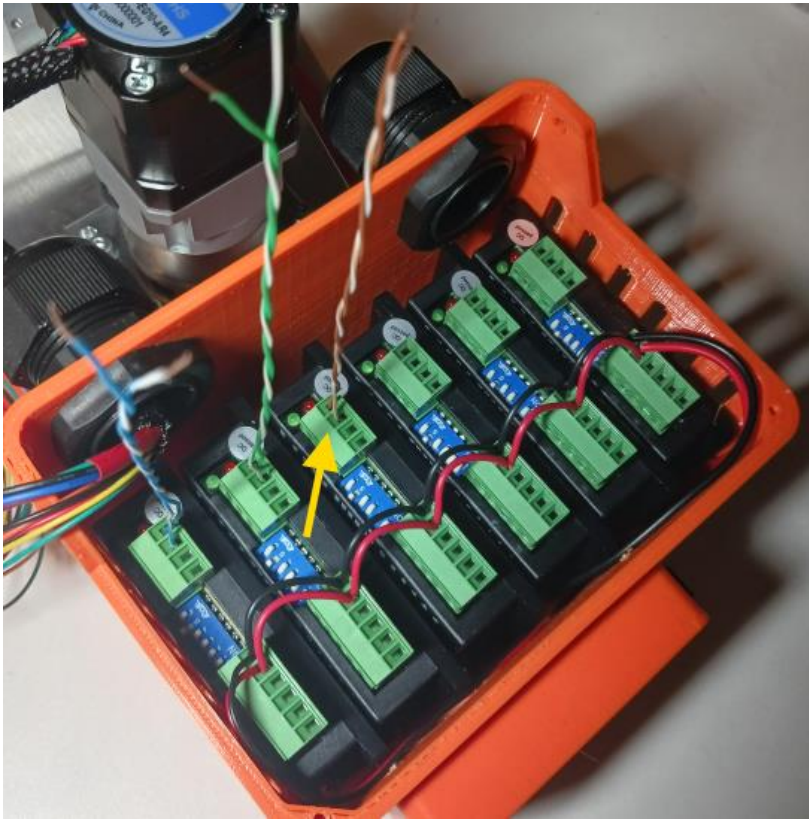

Insert one of the brown pairs of wires into the J3 driver as shown.

The solid brown wire goes to the “PUL” terminal.

The striped wire goes to the “DIR” terminal.

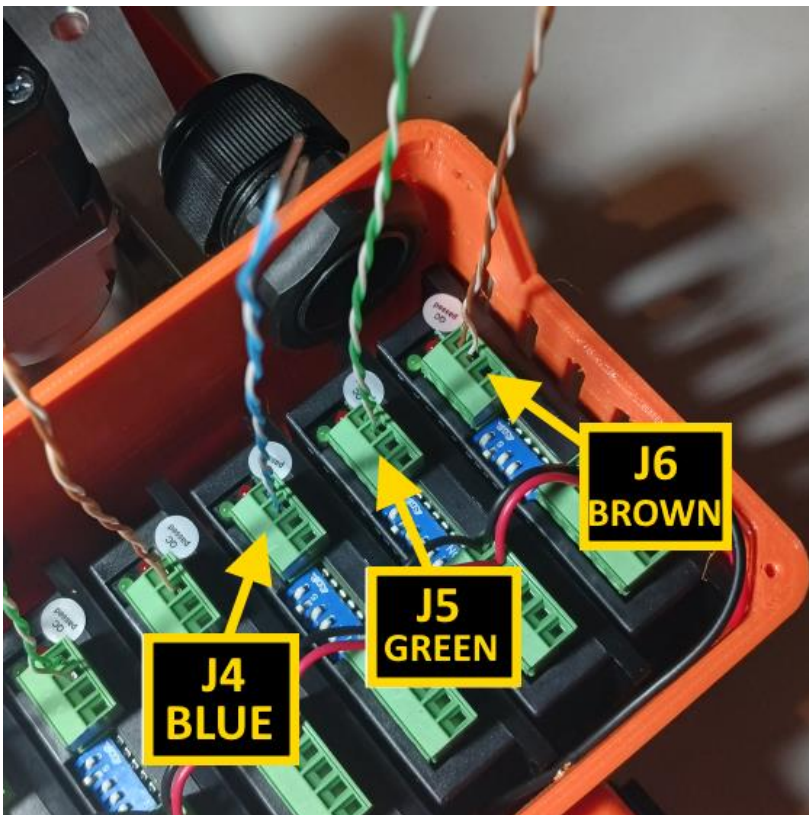
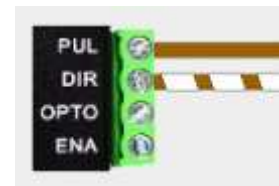

Repeat the previous (3) steps and install a blue pair of wires into the J4 driver, a green pair of wires into the J5 driver and a brown pair of wires into the J6 driver.

The solid color wire should go to the “PUL” terminal and the striped wire should go to the “DIR” terminal.



With the remaining lengths of orange pair wires – separate the solid color from the stripe color wires.

Cut the solid orange wires into lengths of 43mm and strip the ends of (5) of them.

Do not cut the stripe wires.

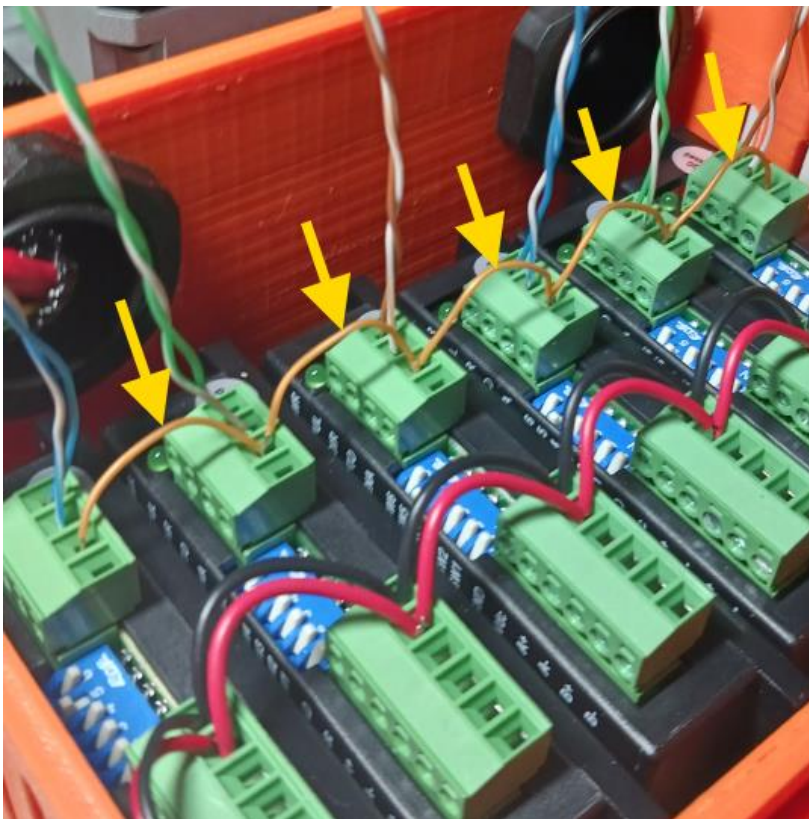

Install the (5) lengths of solid color orange wire from the “OPTO” terminal from one driver to the next.

The “OPTO” terminal should be jumpered across all 6 drivers as shown.

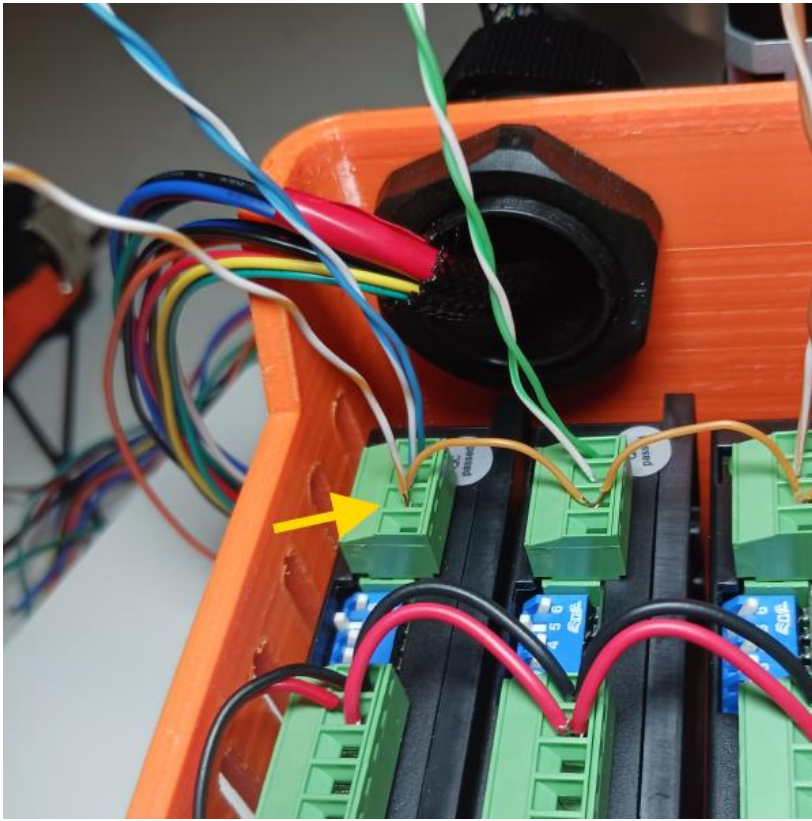

Install (1) of the remaining 130mm long orange stripe wires to the "OPTO" terminal on the far left J1 driver as shown.

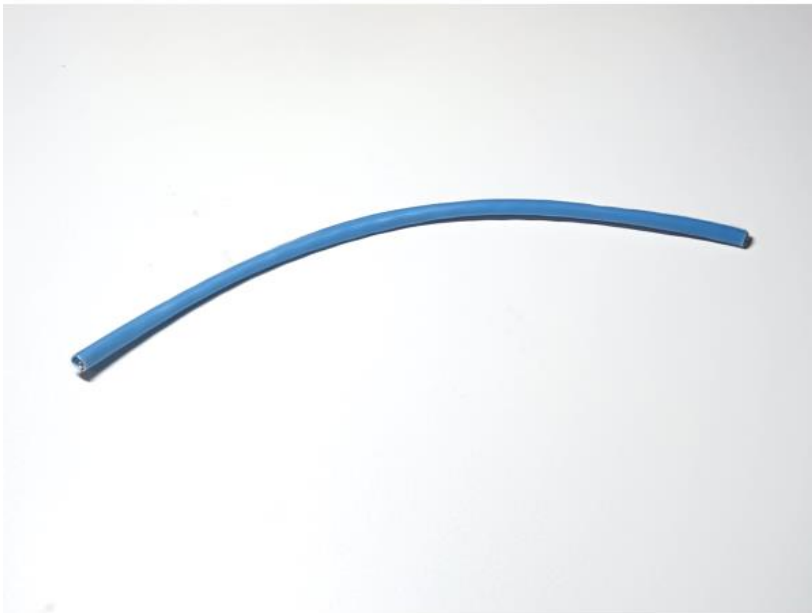

Cut (1) length of solid strand Cat5 cable to a length of 210mm.



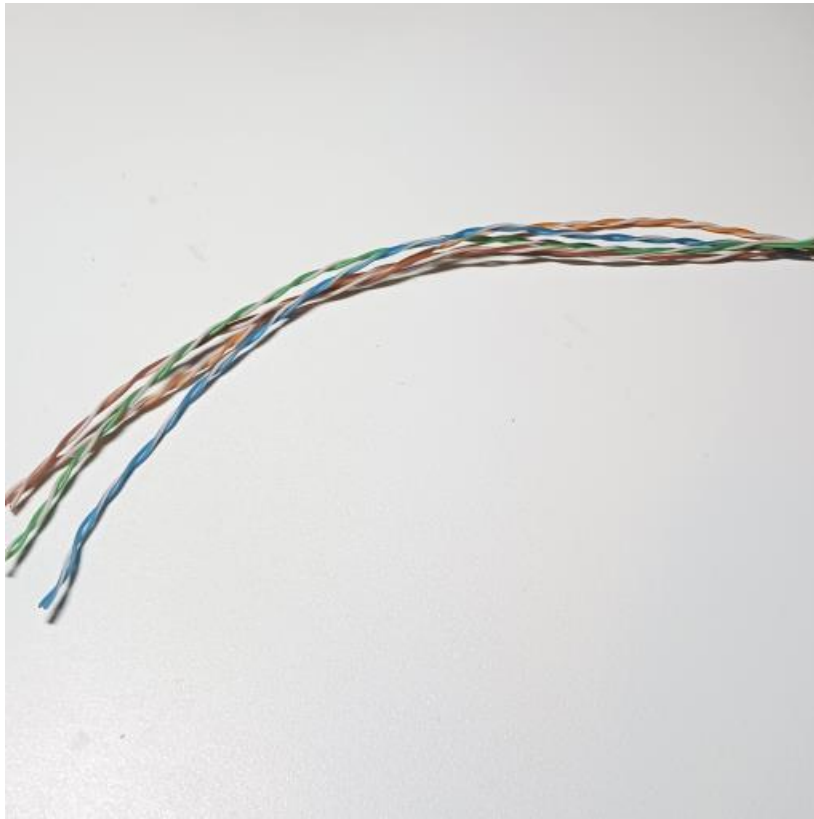

Remove outer sheathing from cable.

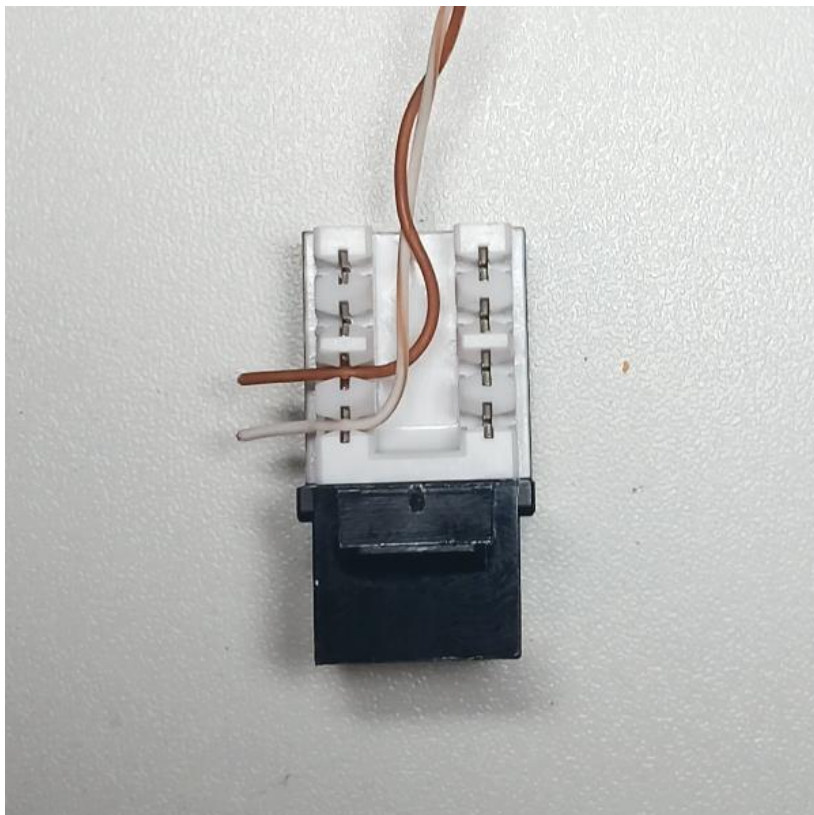

Insert the brown stripe wire into terminal #7 of the CAT6 Keystone Jack.

Insert the solid brown wire into terminal #8 of the CAT6 Keystone Jack.

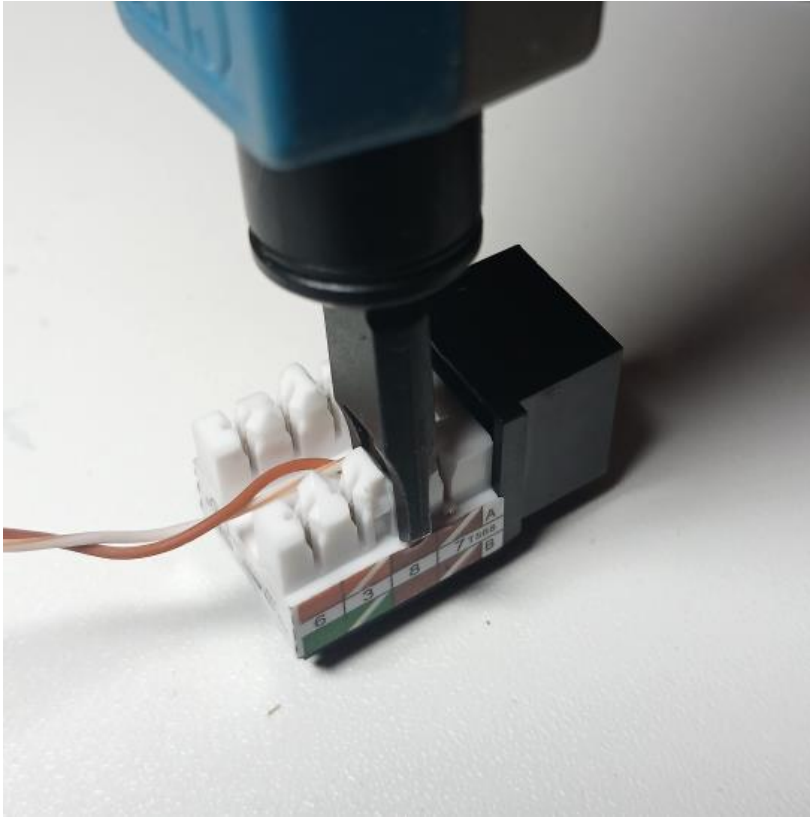

Use a keystone punch down tool to seat and trim both wires into the CAT6 Keystone Jack.

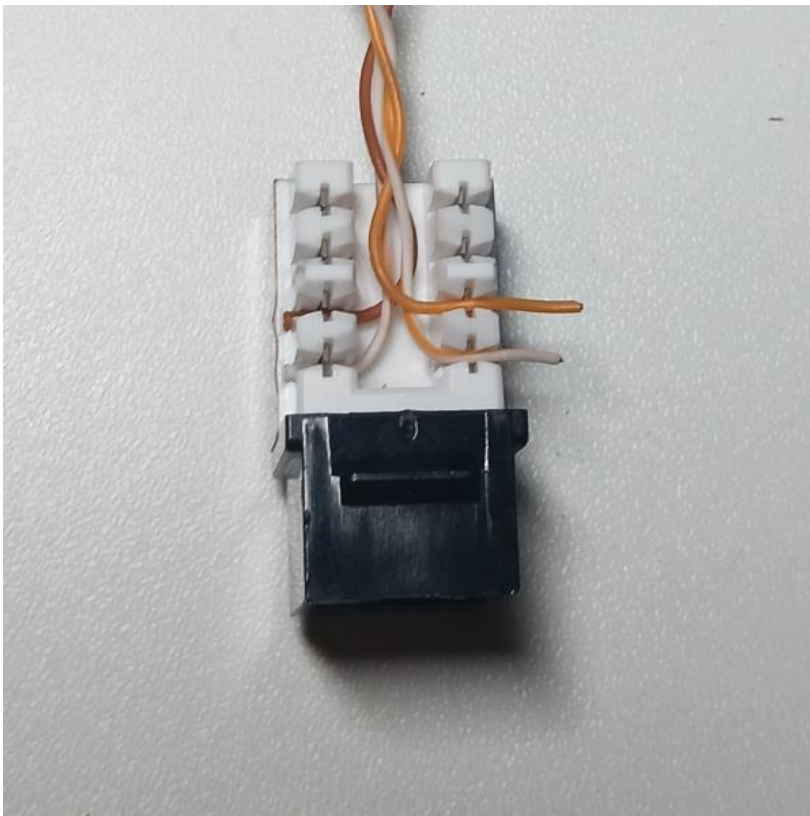

Insert the orange stripe wire into terminal #1 of the CAT6 Keystone Jack.

Insert the solid orange wire into terminal #2 of the CAT6 Keystone Jack.

Then use a keystone punch down tool to seat and trim both wires into the CAT6 Keystone Jack.

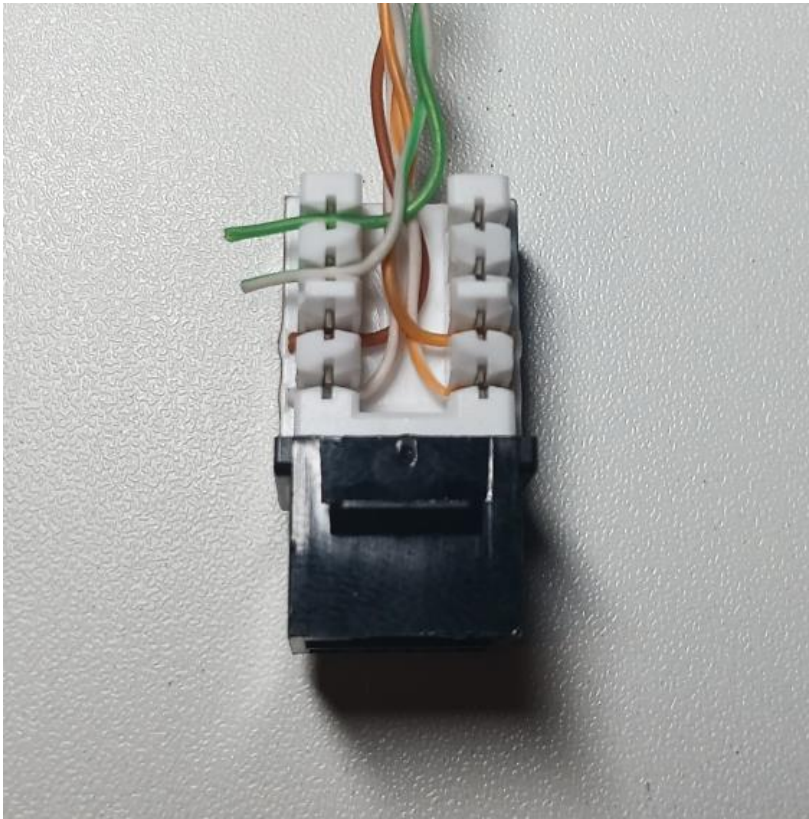

Insert the green stripe wire into terminal #3 of the CAT6 Keystone Jack.

Insert the solid green wire into terminal #6 of the CAT6 Keystone Jack.

Then use a keystone punch down tool to seat and trim both wires into the CAT6 Keystone Jack.

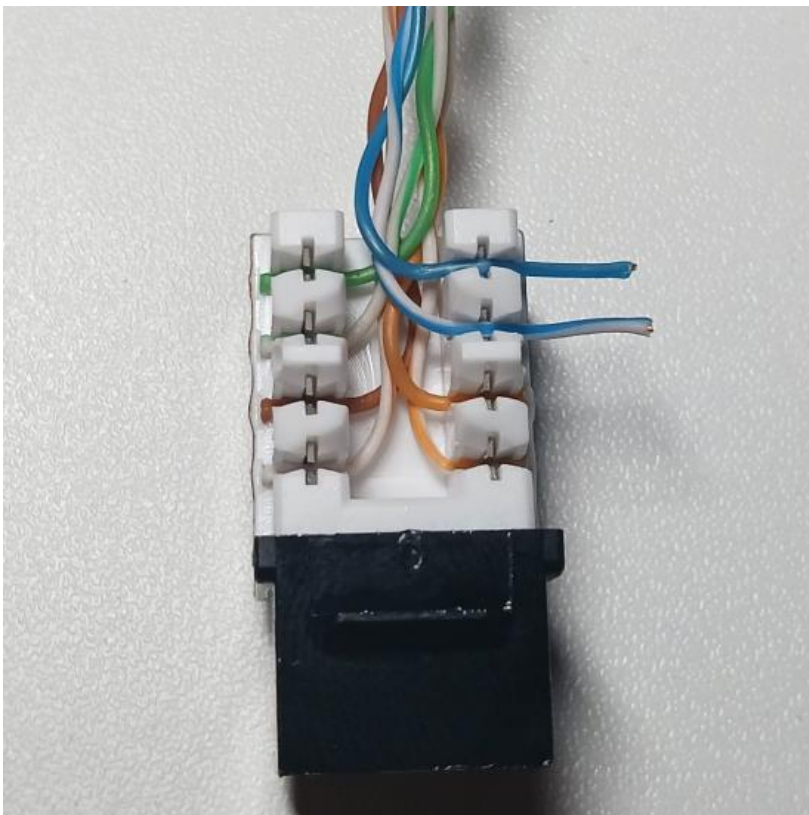

Insert the blue stripe wire into terminal #5 of the CAT6 Keystone Jack.

Insert the solid blue wire into terminal #4 of the CAT6 Keystone Jack.

Then use a keystone punch down tool to seat and trim both wires into the CAT6 Keystone Jack.

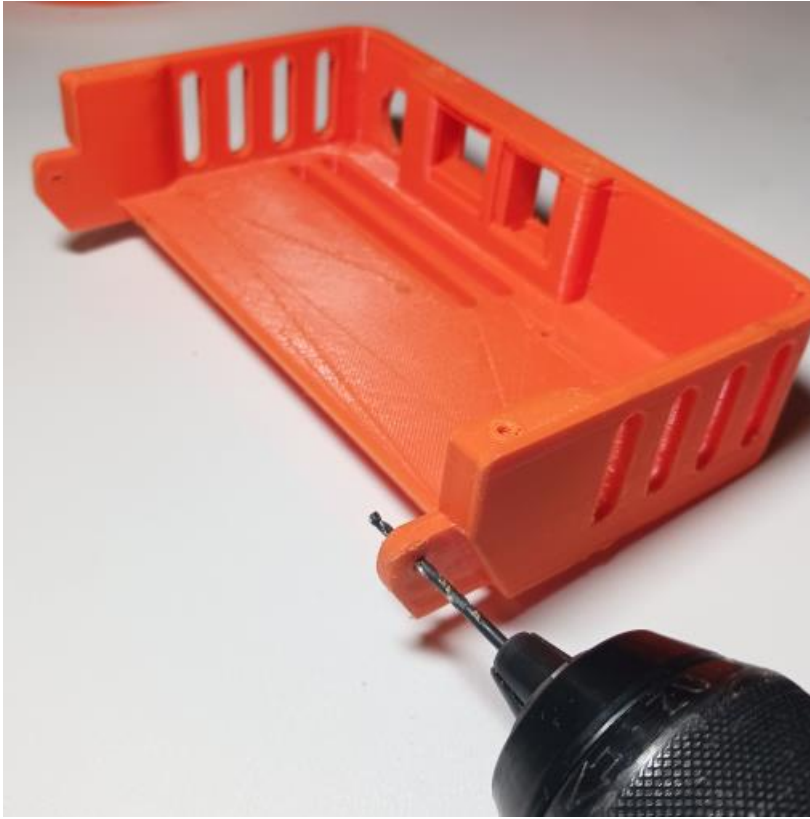

Carefully remove all build structure from the J1 BASE ENCLOSURE TRAY. Use 2mm or 0.080" drill to clear or clean out the (2) hinge holes on each side as shown.

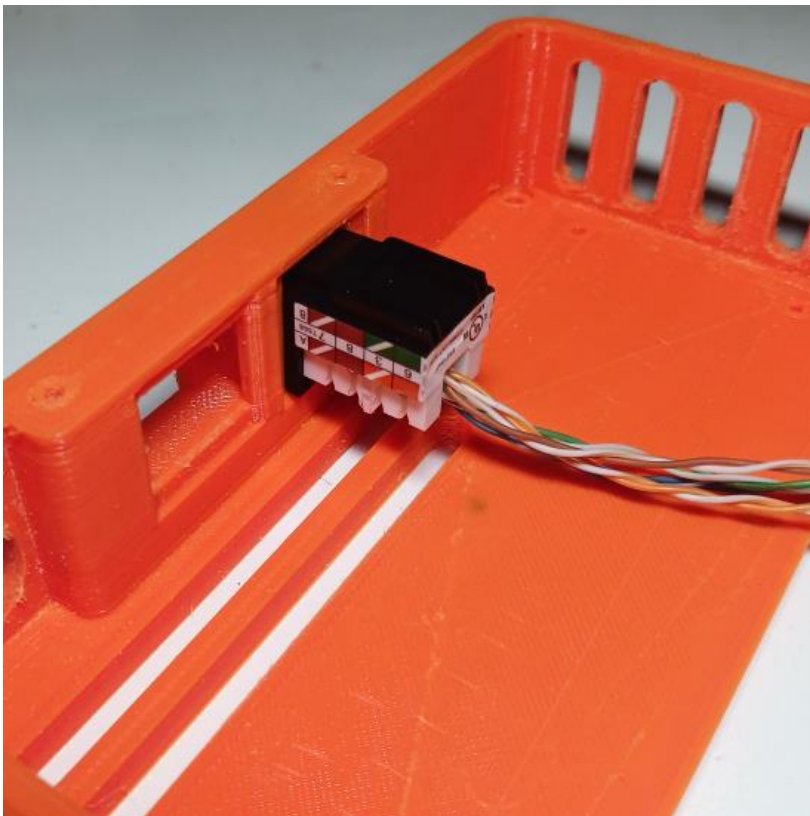

Install the CAT6 Keystone Jack as shown in the right socket of the J1 enclosure tray.



Insert the USB-C end of the USB extension cable into the USB-C 90° Keystone Jack as shown in photo.

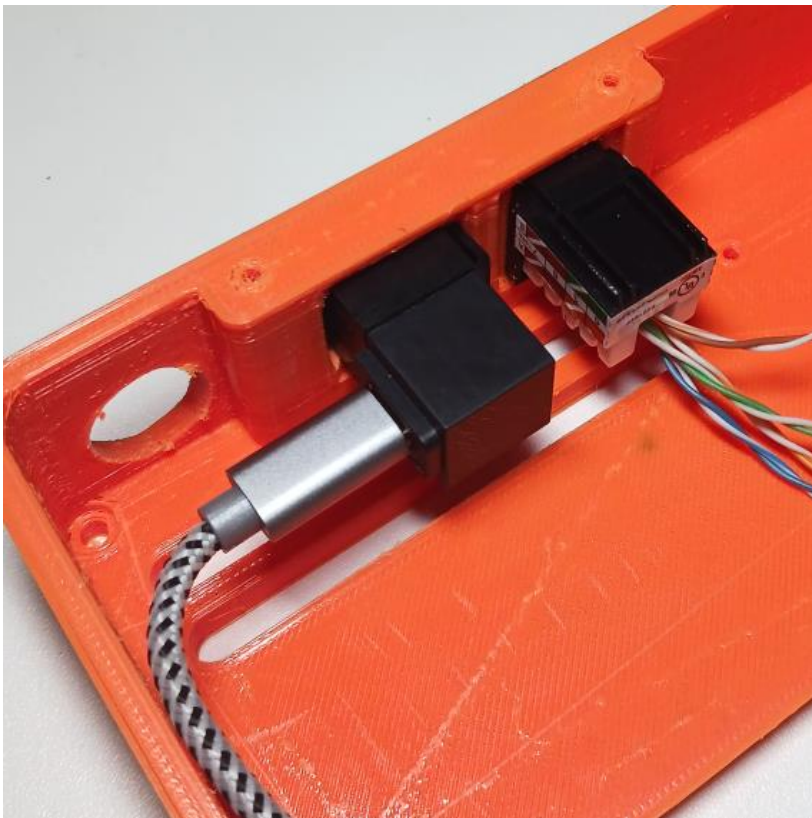

Install USB-C 90° Keystone Jack into left socket of J1 enclosure tray as shown in photo.

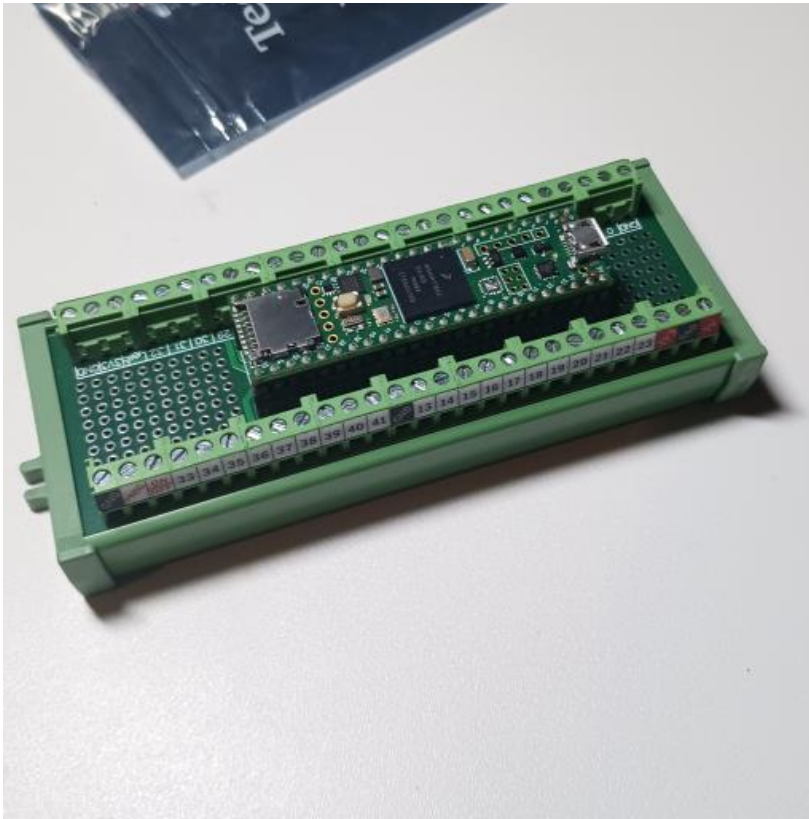

Install Teensy 4.1 control board into the terminal breakout board as shown.

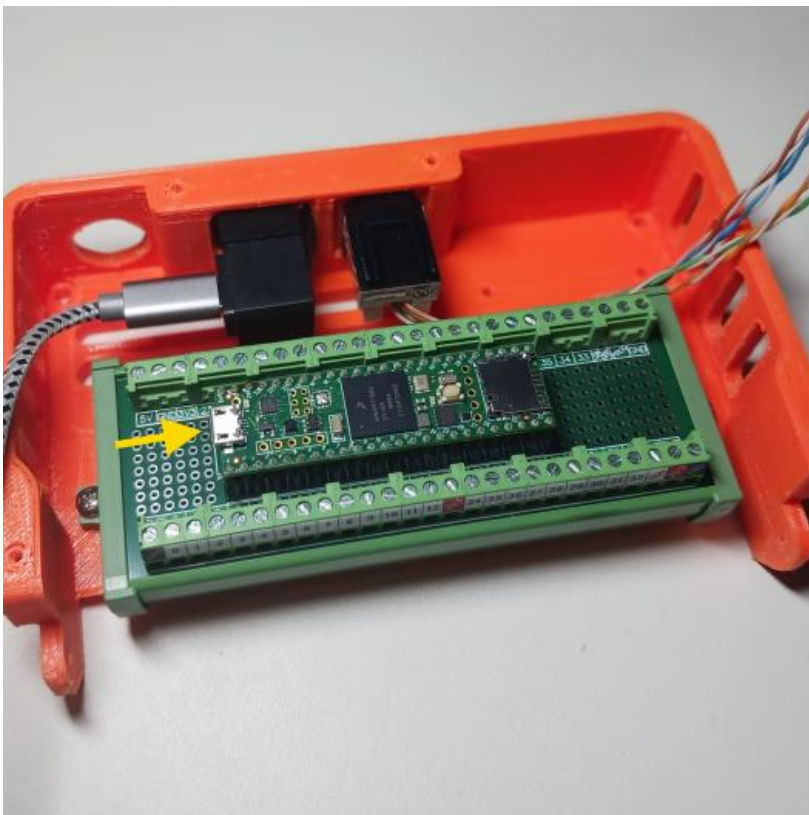

Install Teensy 4.1 and breakout board into J1 enclosure tray as shown and secure with (2) #6 thread form screws.

NOTE: the USB connector should be oriented to the left side as shown in photo (yellow arrow).

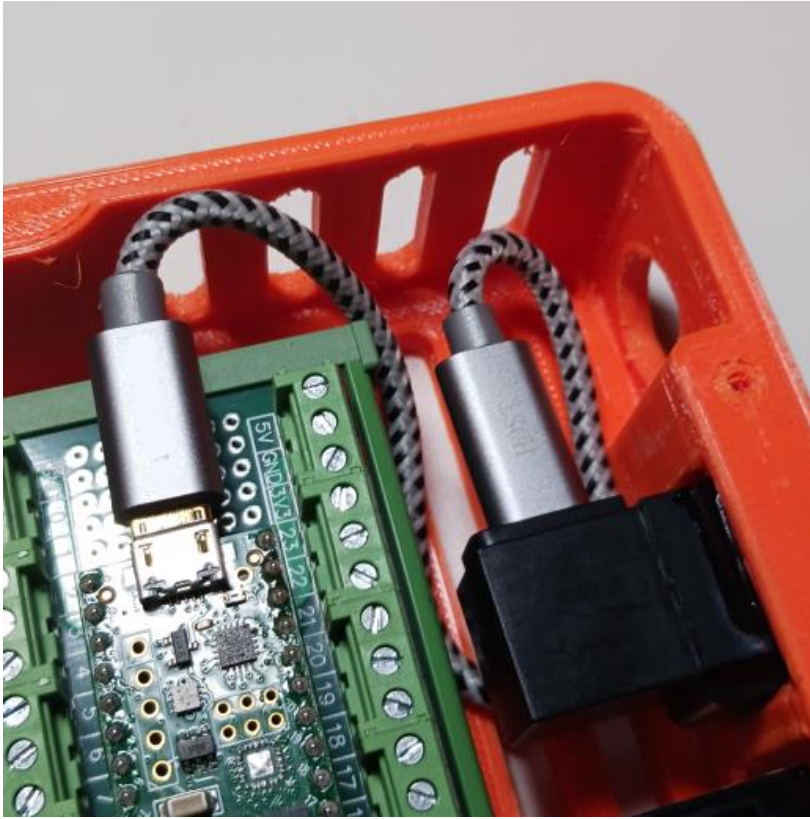

Plug Micro USB end of cable into Teensy 4.1 board and tuck cable down and to the left as shown.

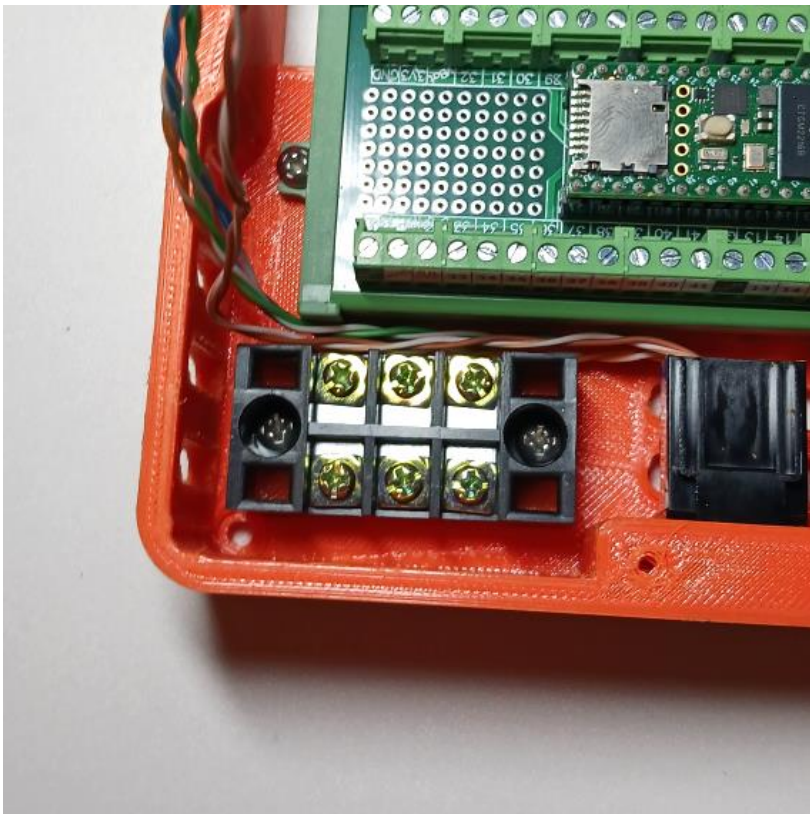

Install the 3 position terminal block into the J1 enclosure tray as shown and secure with (2) #6 thread form screws.

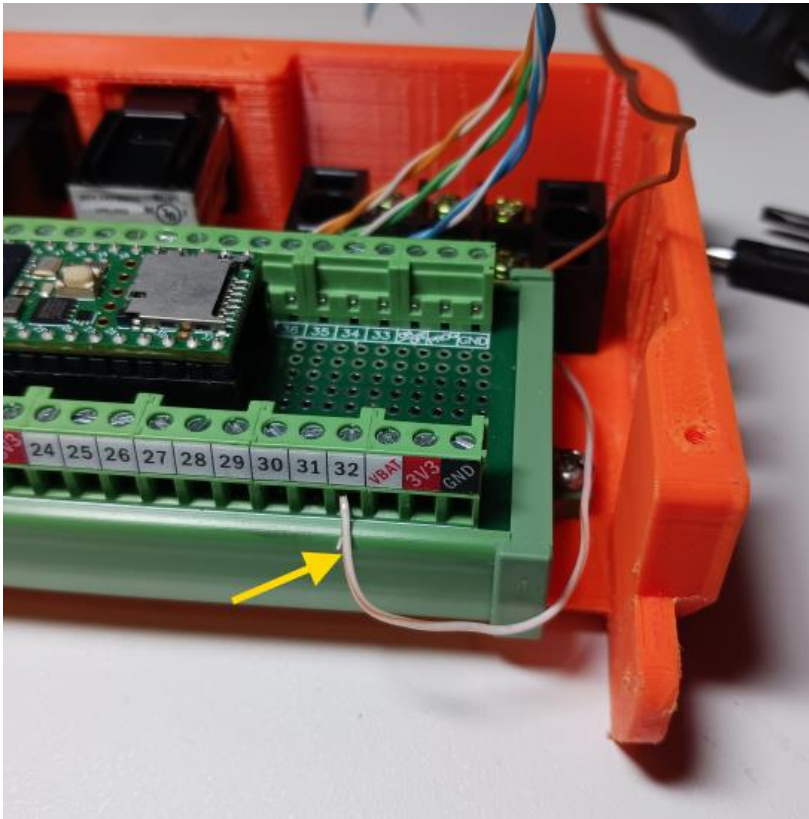

Route the Brown Stripe wire from CAT6 keystone jack along breakout board as shown. Trim wire to length as shown, strip wire end and then insert and secure to terminal 32 of breakout board.

NOTE: Also see wiring schematics section of manual.

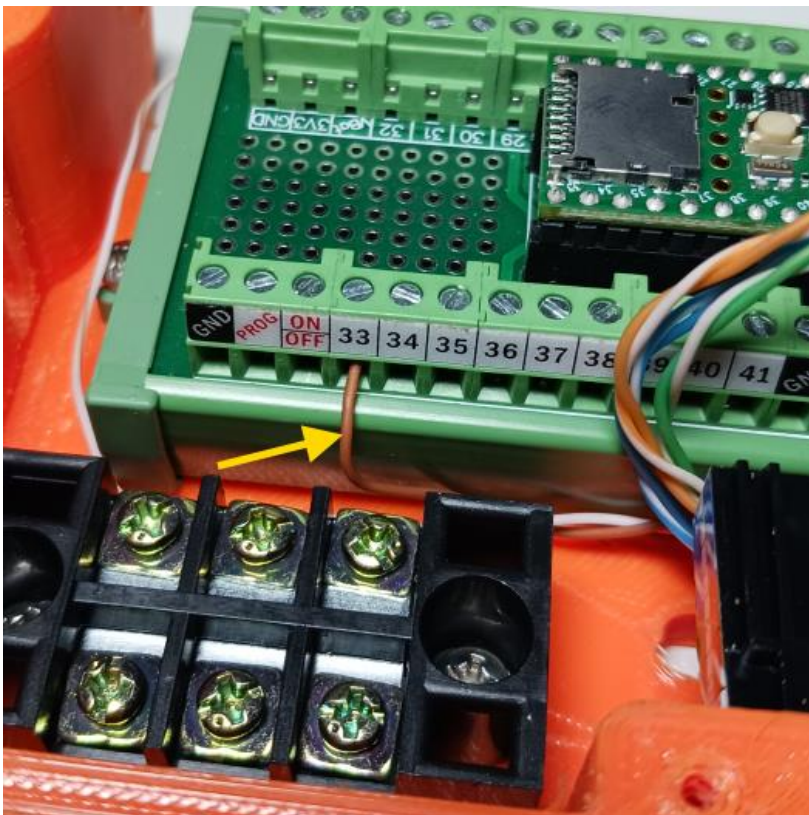

Route the solid Brown wire from CAT6 keystone jack along breakout board as shown. Trim wire to length as shown, strip wire end and then insert and secure to terminal 33 of breakout board.

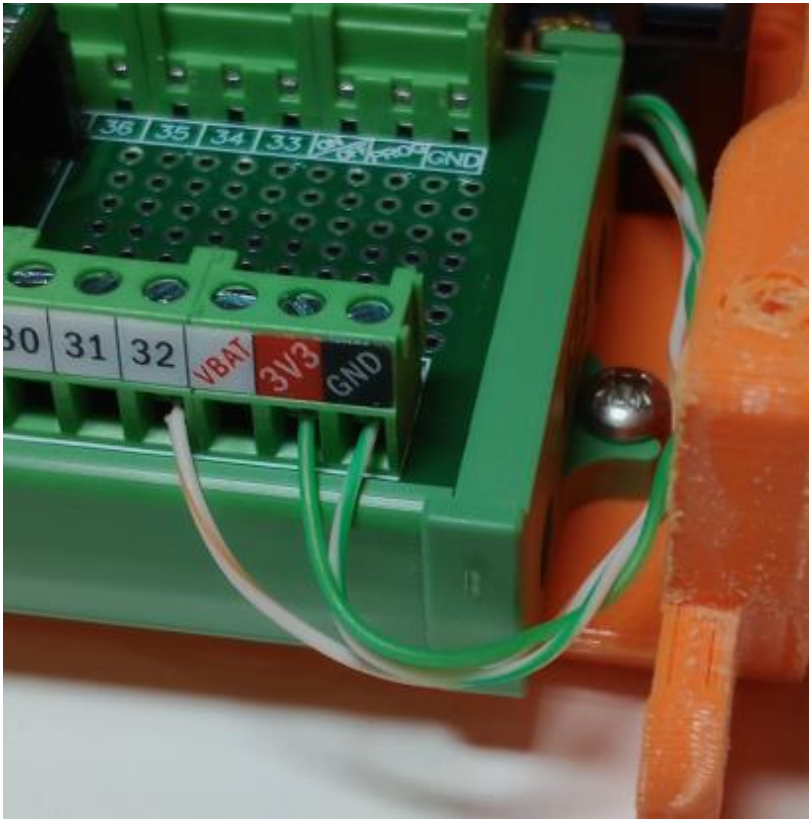

Route the Green Stripe wire from CAT6 keystone jack along breakout board as shown. Trim wire to length as shown, strip wire end and then insert and secure to terminal GND of breakout board where shown.

Route the solid Green wire from CAT6 keystone jack along breakout board as shown. Trim wire to length as shown, strip wire end and then insert and secure to terminal 3V3 of breakout board where shown.

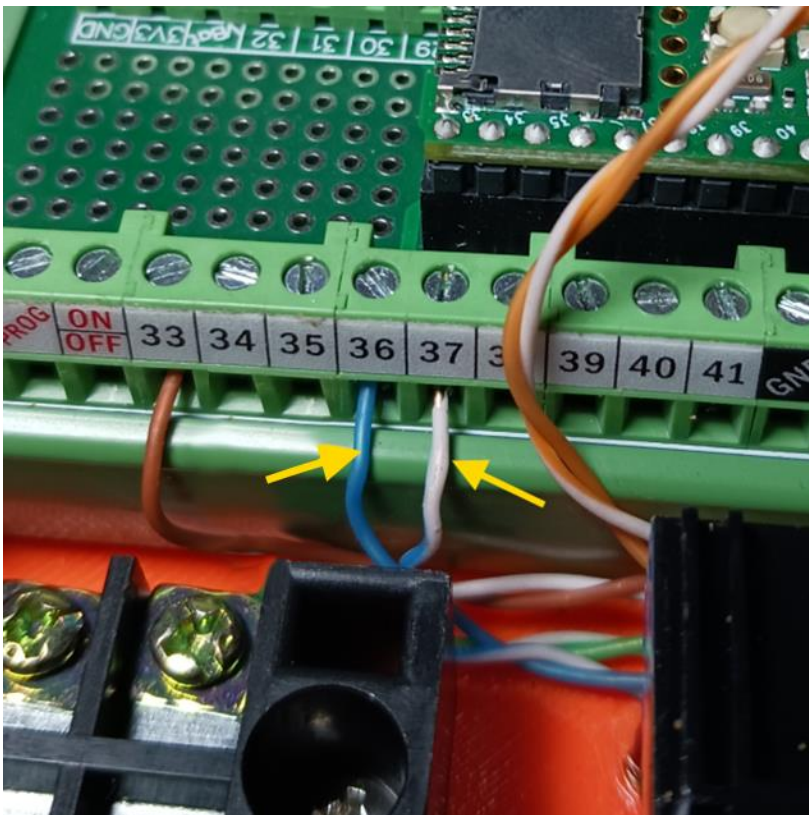

Route the Blue Stripe wire from CAT6 keystone jack along breakout board as shown. Trim wire to length as shown, strip wire end and then insert and secure to terminal 37 of breakout board.

Route the solid Blue wire from CAT6 keystone jack along breakout board as shown. Trim wire to length as shown, strip wire end and then insert and secure to terminal 36 of breakout board.

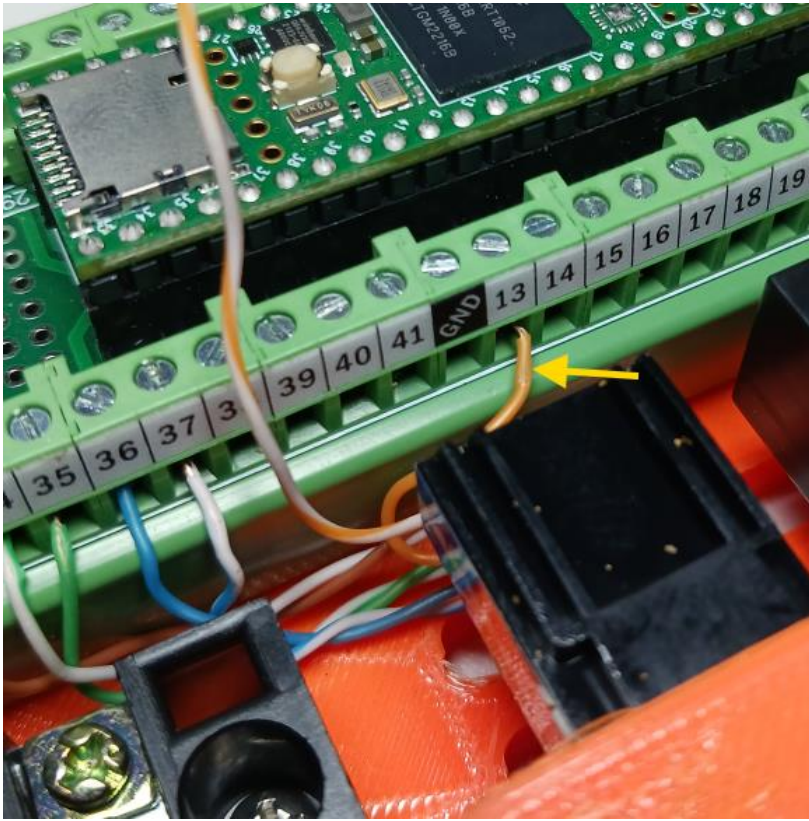

Route the solid Orange wire from CAT6 keystone jack along breakout board as shown. Trim wire to length as shown, strip wire end and then insert and secure to terminal 13 of breakout board.

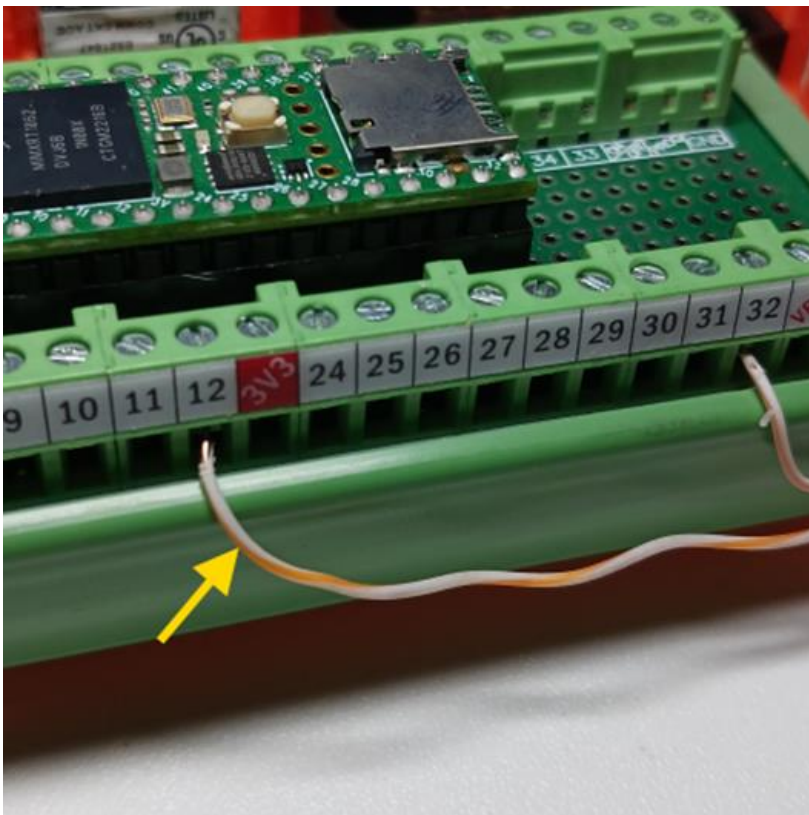

Route the Orange Stripe wire from CAT6 keystone jack along breakout board as shown. Trim wire to length as shown, strip wire end and then insert and secure to terminal 12 of breakout board.

NOTE: Also see wiring schematics section of manual.

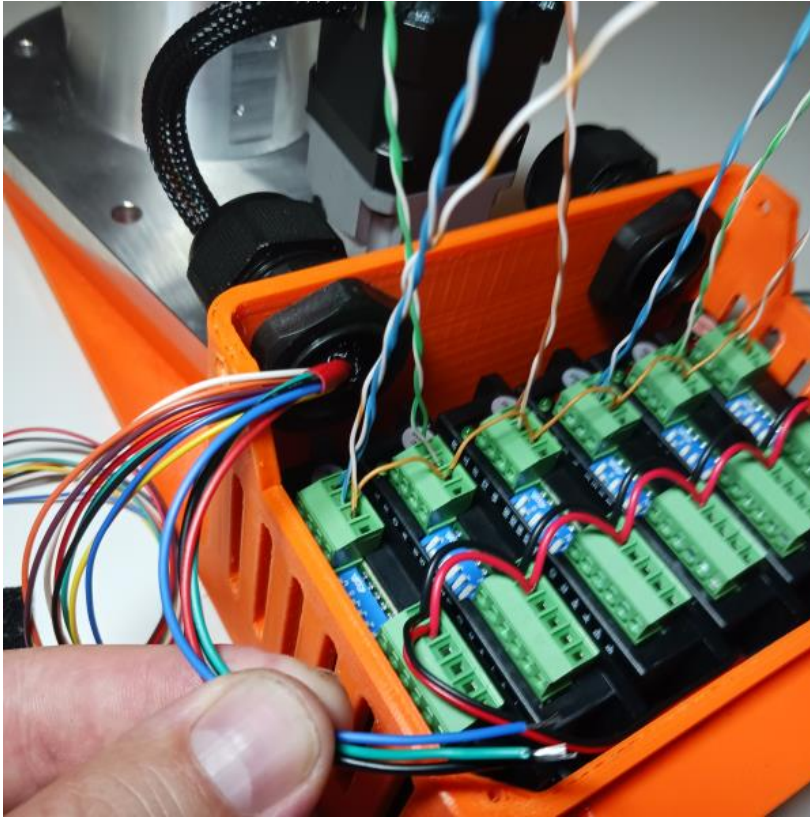

In the J1 main enclosure separate the 4 motor wires from the encoder wires (these are the 4 wires that were taped previously) and cut the wires as shown so that they are the appropriate length to reach the J1 driver terminals.

The wires should be approx.. 100mm in length from the gland nut where they enter the enclosure.

NOTE: save the remainder motor wires for a future step.

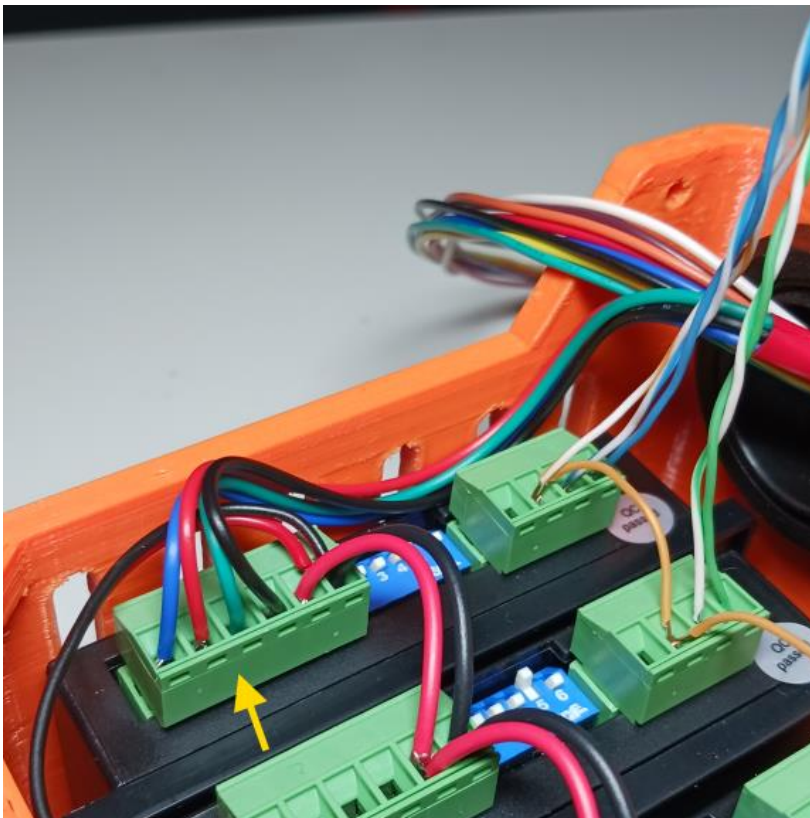

Connect the (4) J1 motor wires to the J1 driver terminals as follows:

A+ BLACK

A- GREEN

B+ RED

B- BLUE

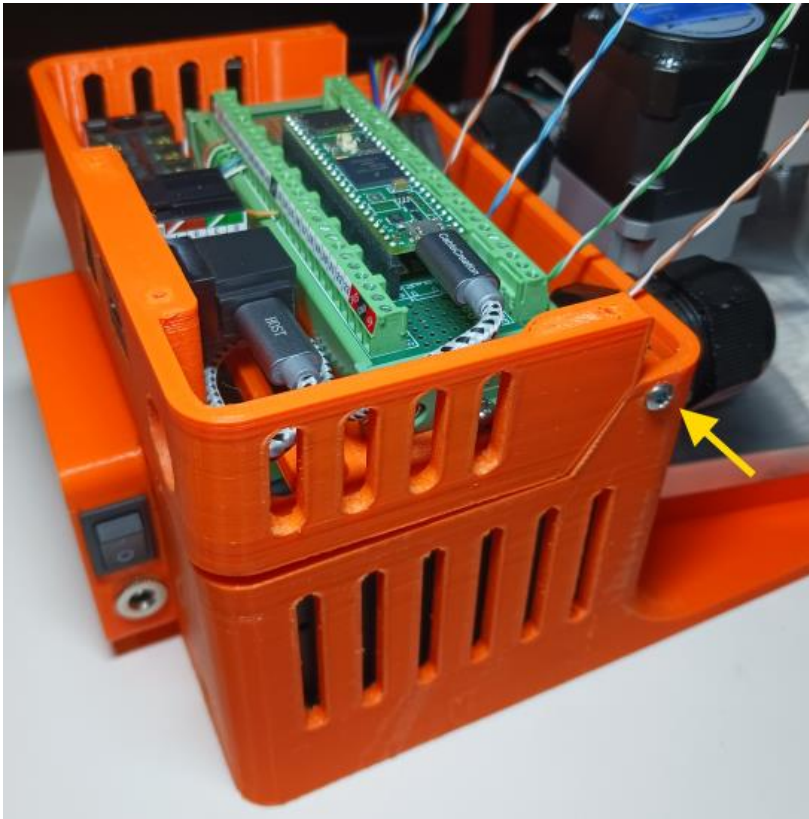

Install the J1 enclosure tray onto the main base enclosure as shown.

Secure tray to base using (2) #6 thread form screws installed at the hinge locations on both sides (yellow arrow).

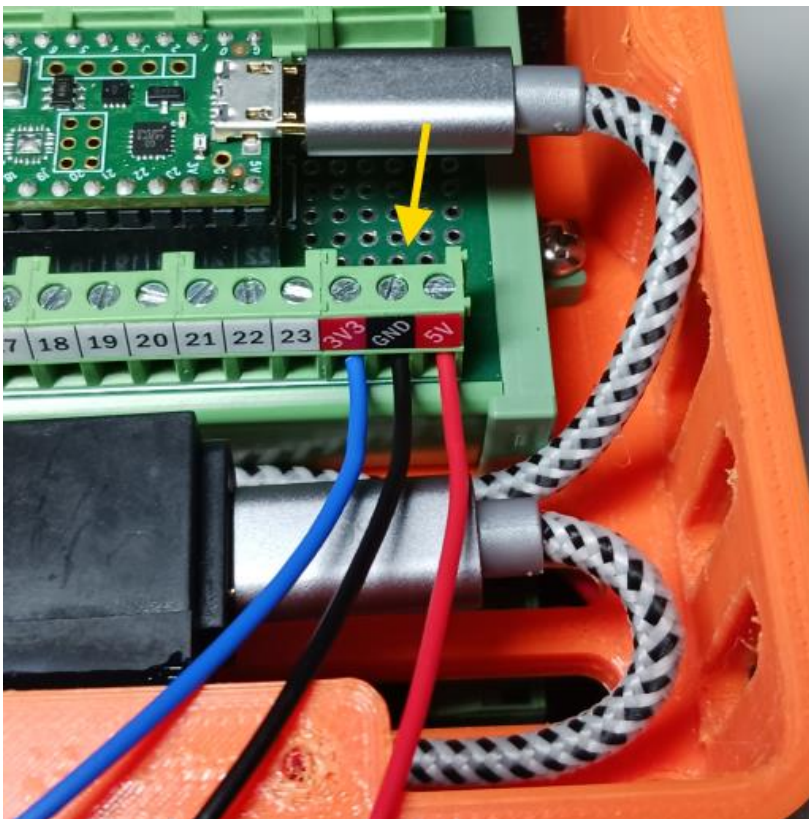

Use (3) of the remaining motors wires (red, black, blue) and connect them to the breakout board connectors as follows:

5V RED

GND BLACK

3.3V BLUE

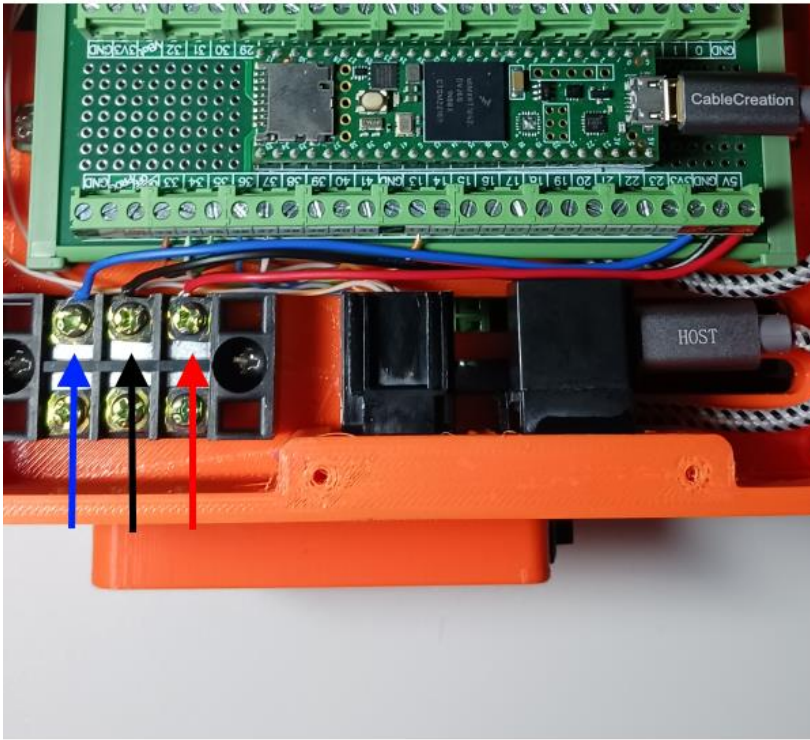

Route the red, black and blue wires along breakout board as shown, trim and strip wire ends and connect them to the 3 position terminal block as follows:

- 3.3V BLUE** to left terminal.
- GND BLACK** to center.
- 5V red** to right terminal.

NOTE: it can be difficult to maneuver the wire ends under the terminal, I've found it easiest to remove the terminals with a magnetic screw driver, position the wire end and then screw the terminal back down.

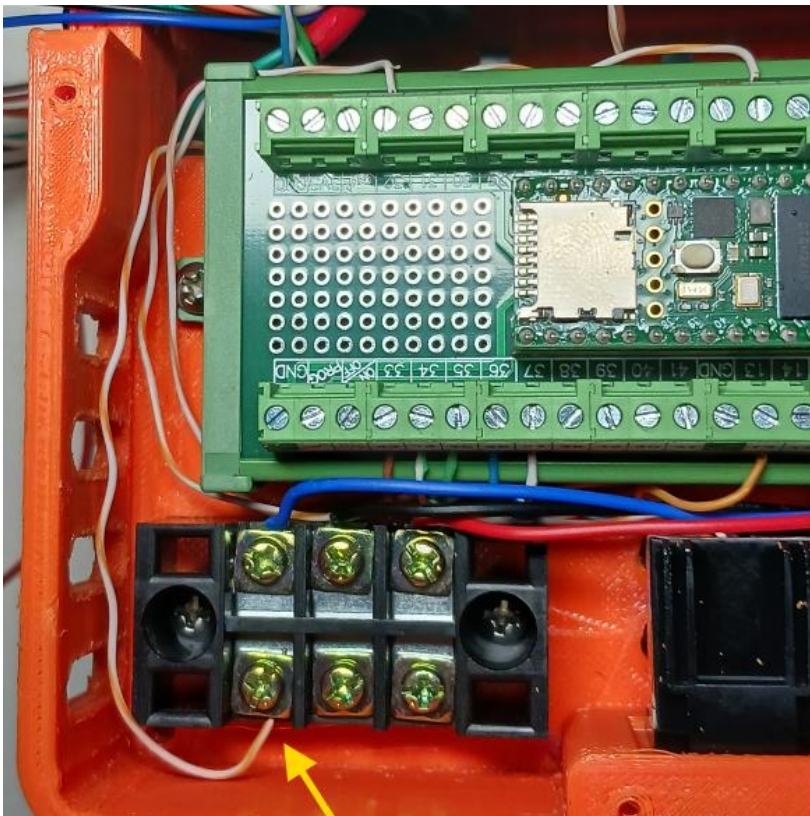

Connect the Orange stripe wire coming from the J1 driver OPTO terminal to the left 3.3V terminal on the 3 position terminal block as shown (yellow arrow).



Connect the blue wires coming from the J1 driver to the teensy board as follows:

J1 driver “PUL” (solid blue) connect to terminal “0”

J1 driver “DIR” (blue stripe) connect to terminal “1”

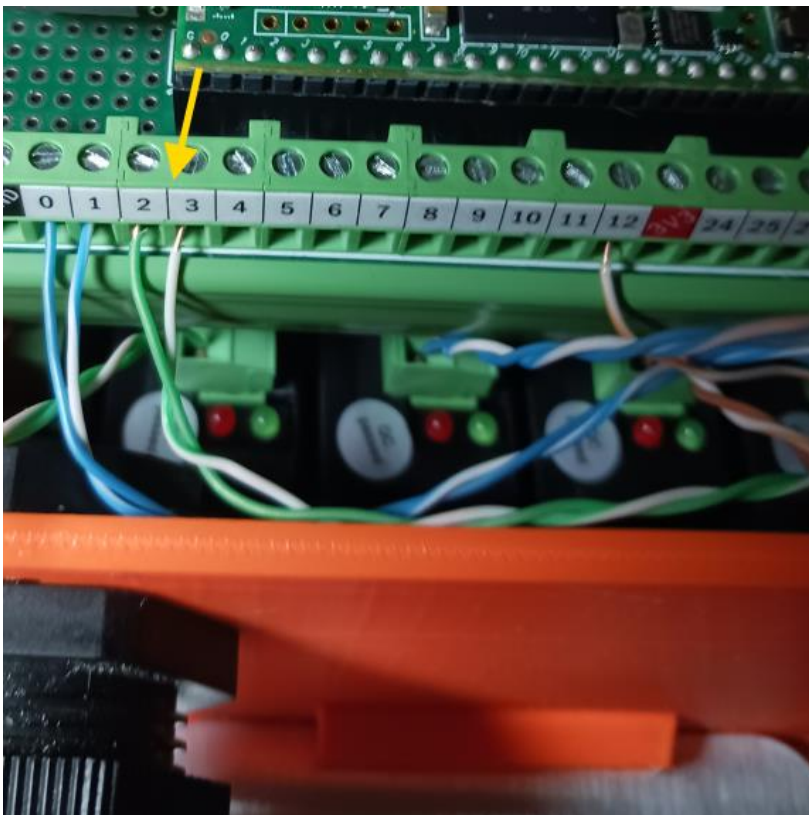

Connect the green wires coming from the J2 driver to the teensy board as follows:

J2 driver “PUL” (solid green) connect to terminal “2”

J2 driver “DIR” (green stripe) connect to terminal “3”

NOTE: Also see [wiring schematics section of manual](#).

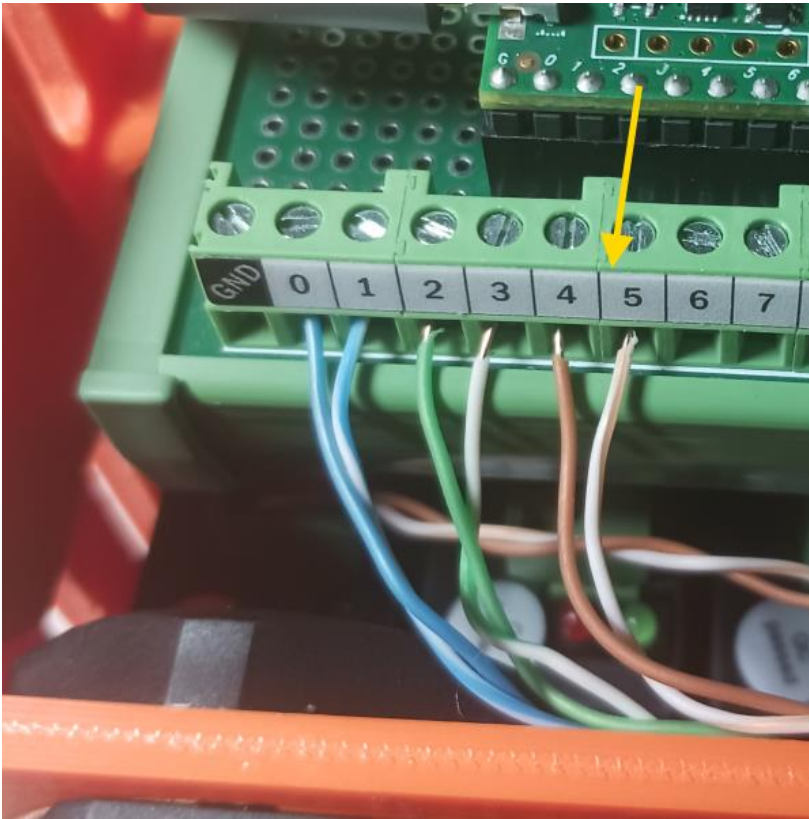

Connect the brown wires coming from the J3 driver to the teensy board as follows:

J3 driver “PUL” (solid brown) connect to terminal “4”

J3 driver “DIR” (brown stripe) connect to terminal “5”

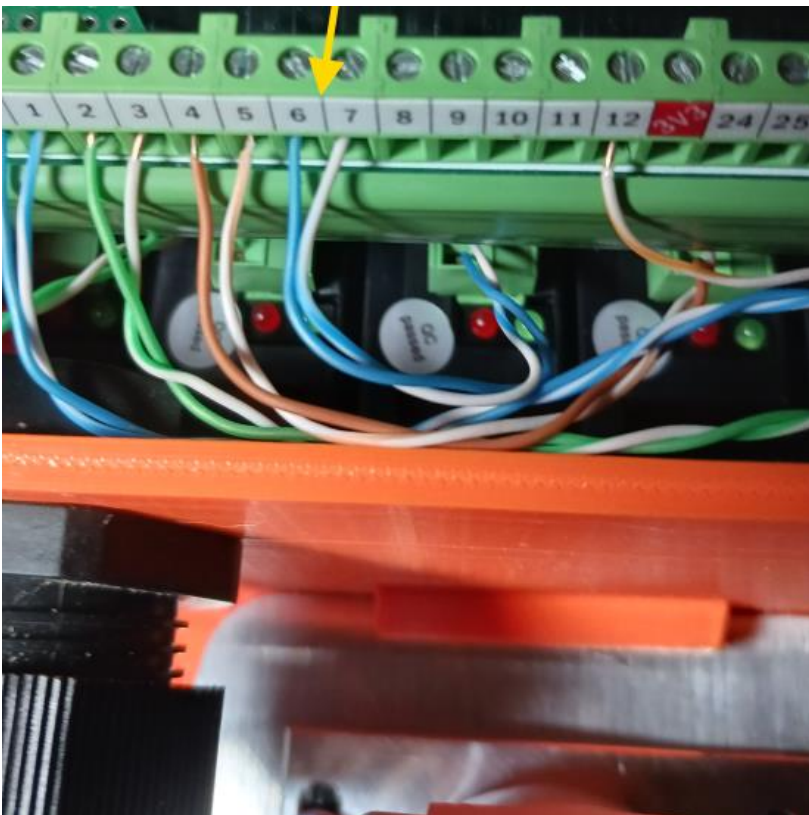

Connect the blue wires coming from the J4 driver to the teensy board as follows:

J4 driver “PUL” (solid blue) connect to terminal “6”

J4 driver “DIR” (blue stripe) connect to terminal “7”

NOTE: Also see wiring schematics section of manual.



Connect the green wires coming from the J5 driver to the teensy board as follows:

J5 driver "PUL" (solid green) connect to terminal "8"

J5 driver "DIR" (green stripe) connect to terminal "9"

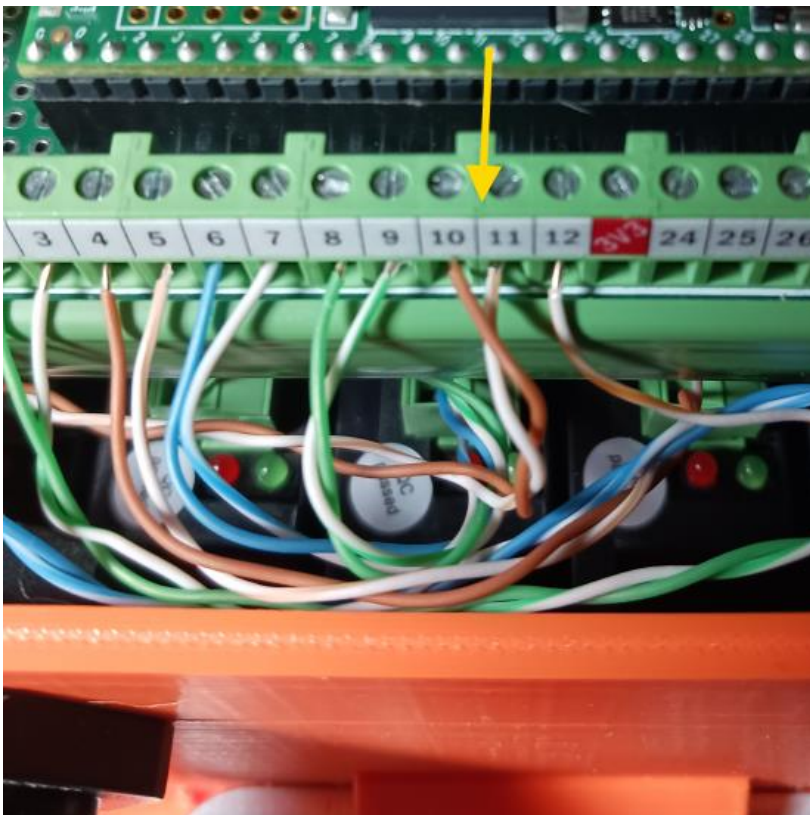

Connect the brown wires coming from the J6 driver to the teensy board as follows:

J6 driver "PUL" (solid brown) connect to terminal "10"

J6 driver "DIR" (brown stripe) connect to terminal "11"

NOTE: Also see wiring schematics section of manual.

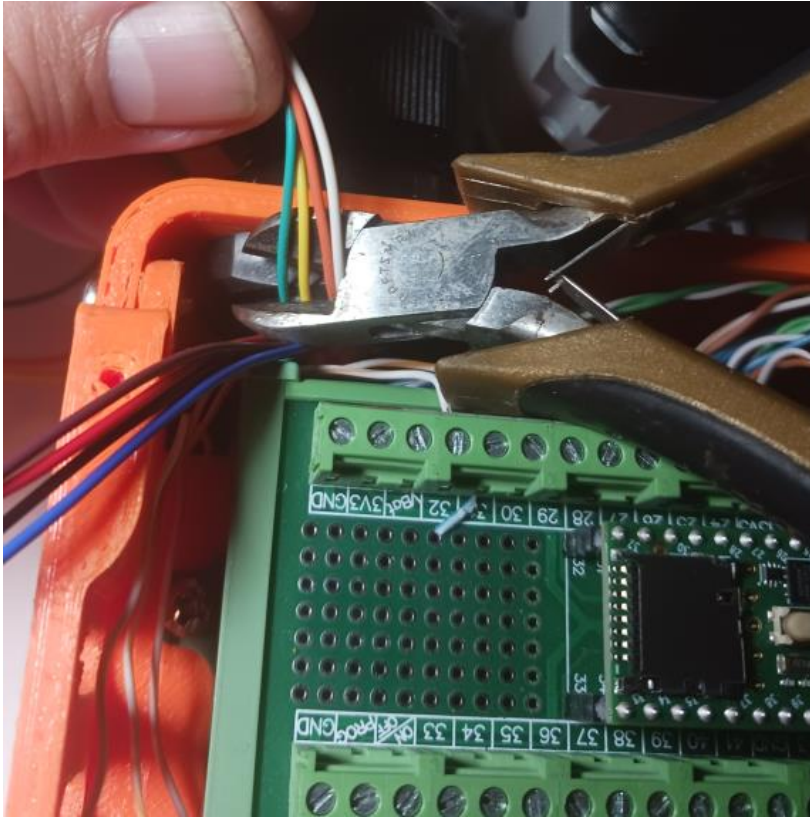

Cut and remove the J1 encoder green, yellow, orange and white wires as they are not used.

Save the remaining wires for a future step.

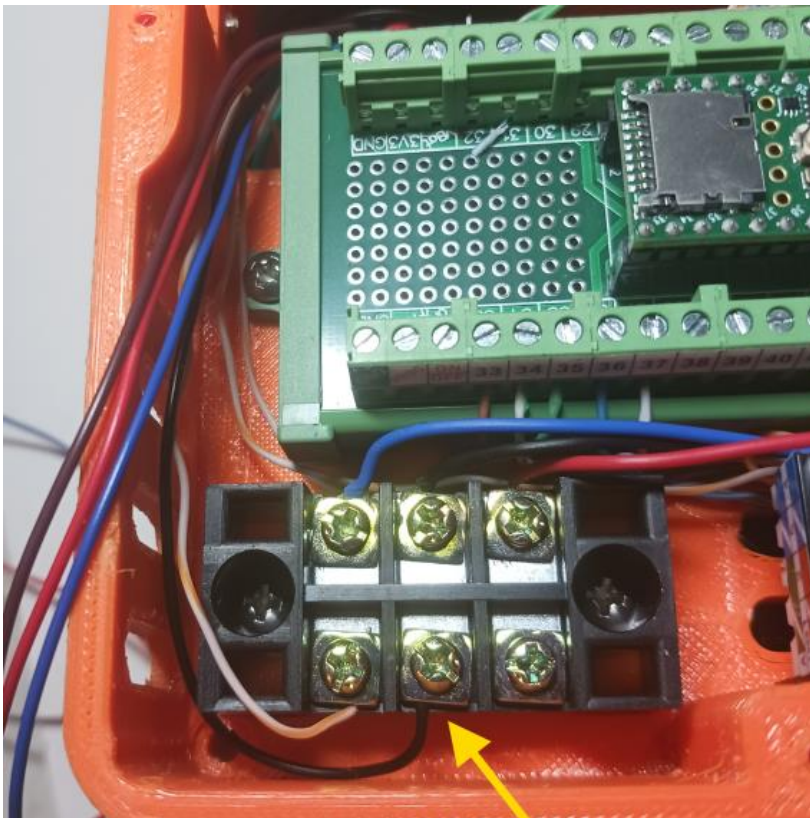

Connect J1 encoder black wire to center GND terminal of 3 position terminal block (yellow arrow).

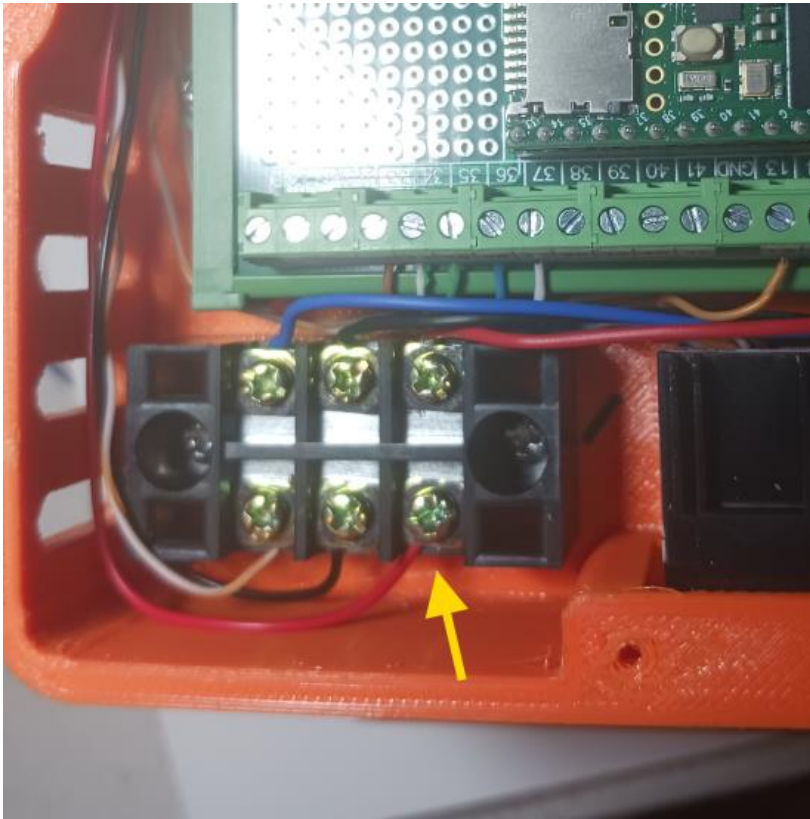

Connect J1 encoder red wire to right 5V terminal of 3 position terminal block (yellow arrow).

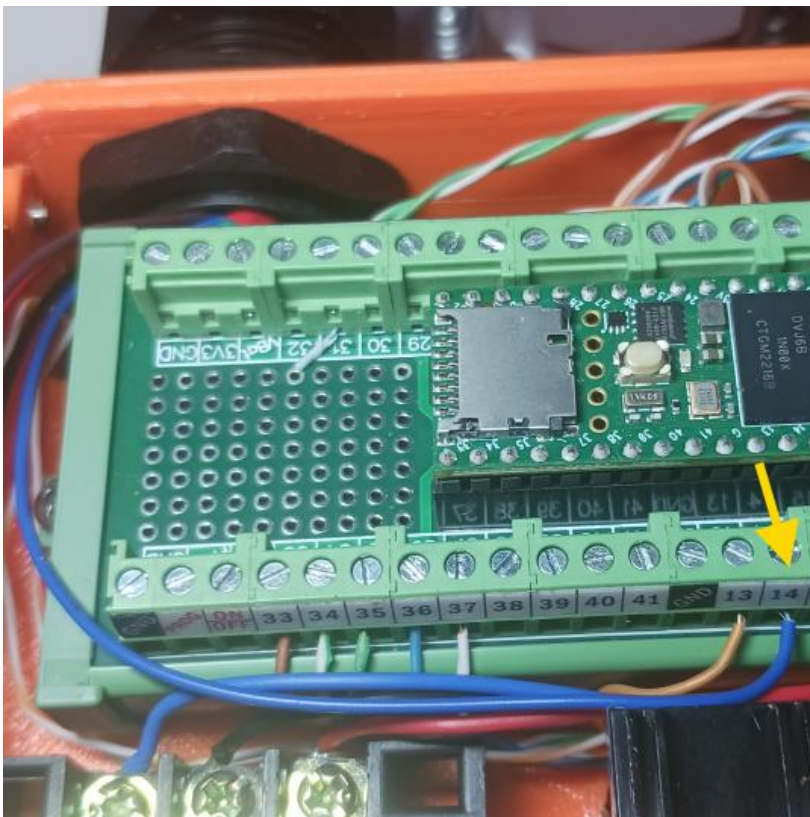

Route J1 encoder blue wire to terminal 14 as shown and cut to length. Strip wire end and connect to terminal 14.

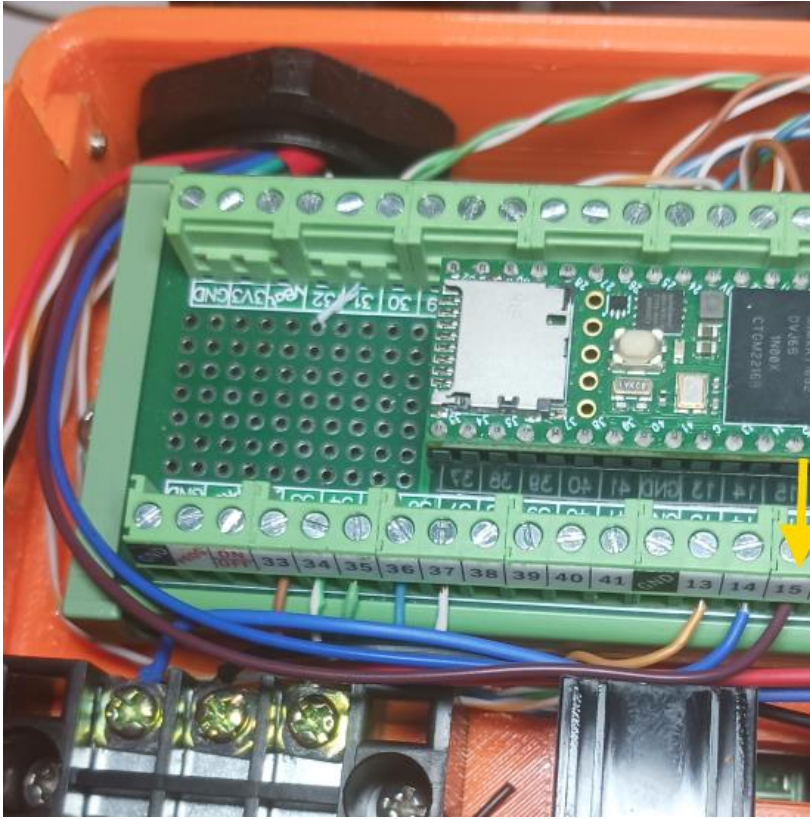

Route J1 encoder brown wire to terminal 15 as shown and cut to length. Strip wire end and connect to terminal 15.

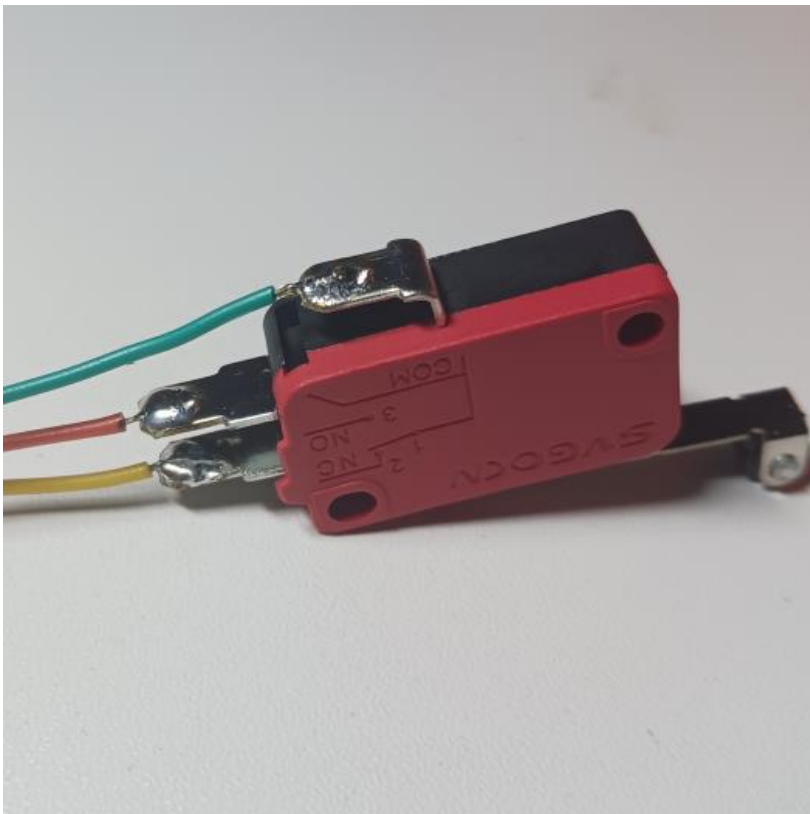

Use the remainder wire from the J1 encoder and solder the green wire to the side "COM" terminal. Solder the orange wire to the center "NO" terminal and then solder the yellow wire to the "NC" terminal

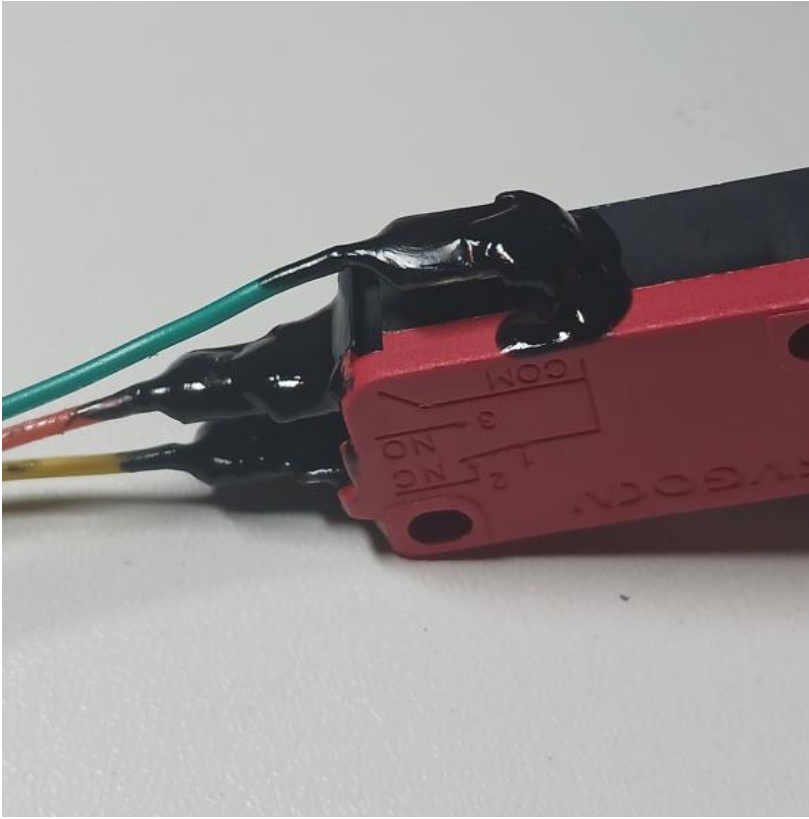

I recommend coating the exposed terminals with liquid electrical tape.

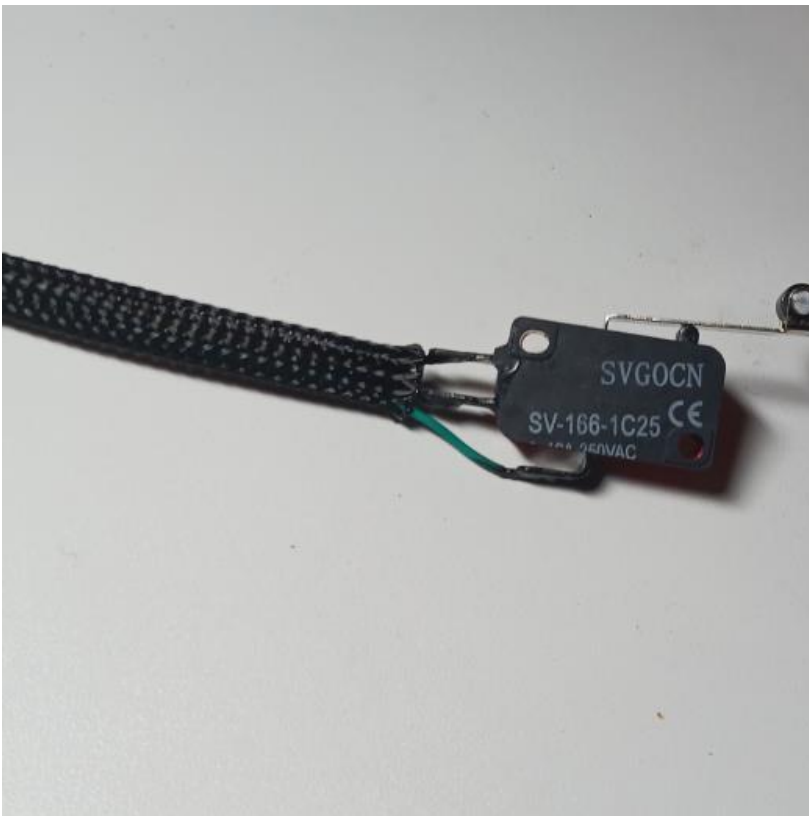

Cut length of ¼" braided sleeve to a length of 15.5cm long then route the J1 limit switch wires through the sleeve as shown.

It is recommended to use a lighter to slightly singe the ends of the braided sleeve to prevent the braided sleeve from fraying and becoming unbraided.

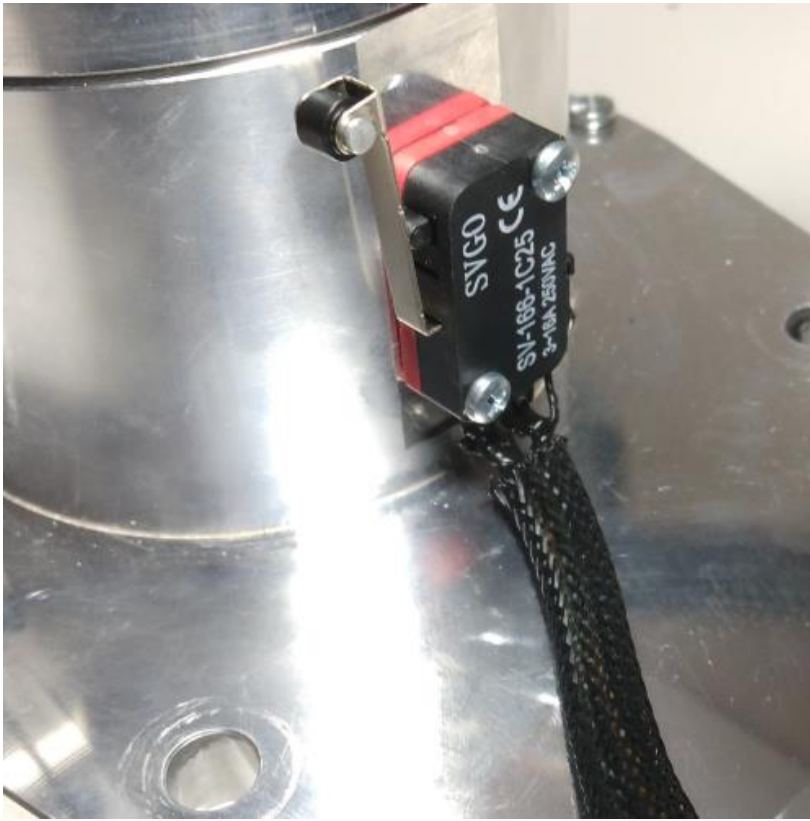

Use (2) M3x14 Philips pan head screws to secure switch to J1 housing as shown in photo.

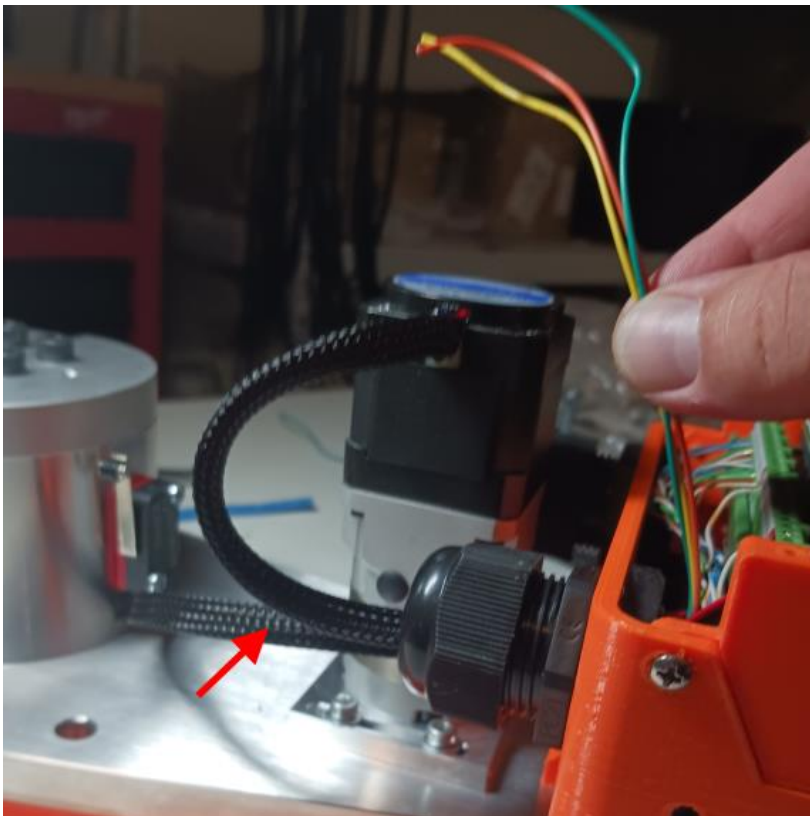

Route the J1 limit switch sleeve (red arrow) into the left PG21 gland nut as shown and route the green, orange and yellow wires into the base enclosure as shown in photo.

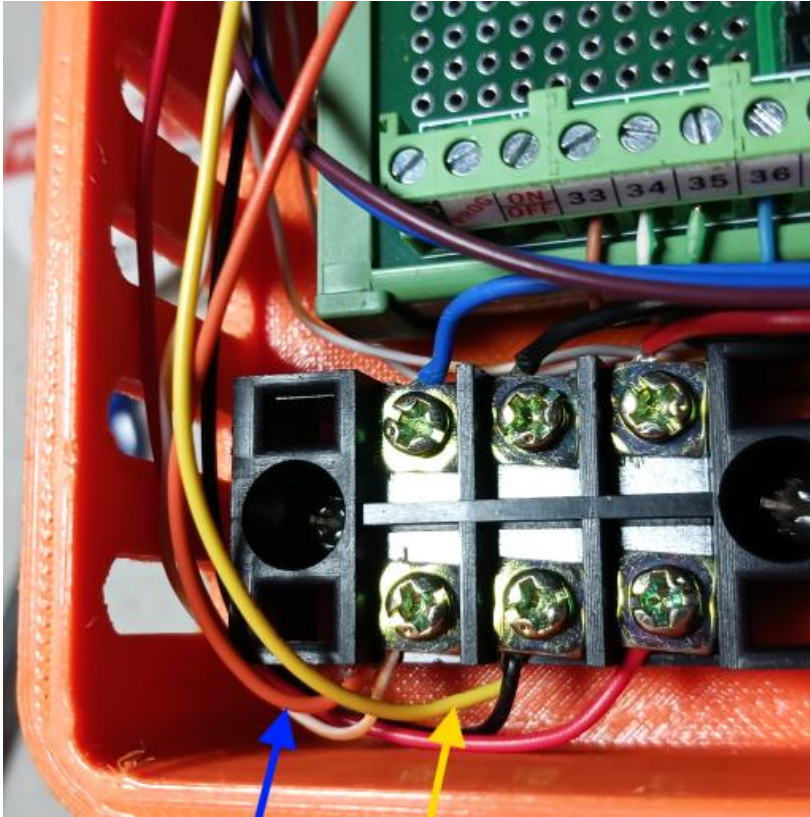

Route and terminate the J1 limit switch orange wire to the left 3.3v terminal on the 3 terminal block (blue arrow).

Route and terminate the J1 limit switch yellow wire to the center GND terminal on the 3 terminal block (yellow arrow).

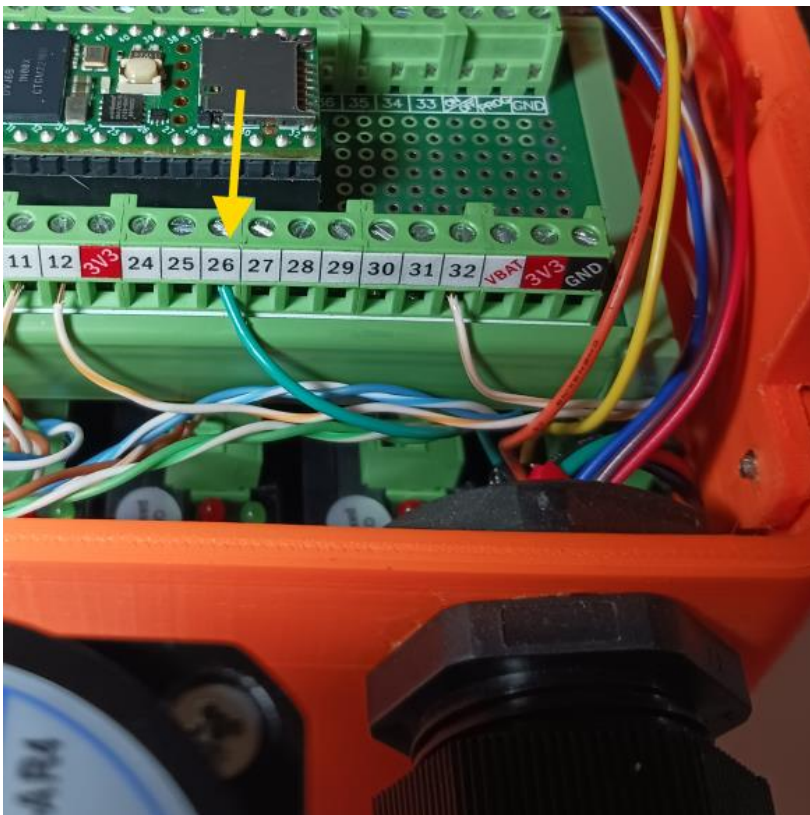

Route J1 limit switch green wire to terminal 26 as shown and cut to length. Strip wire end and connect to terminal 26.

NOTE: also see schematics chapter for wiring diagram

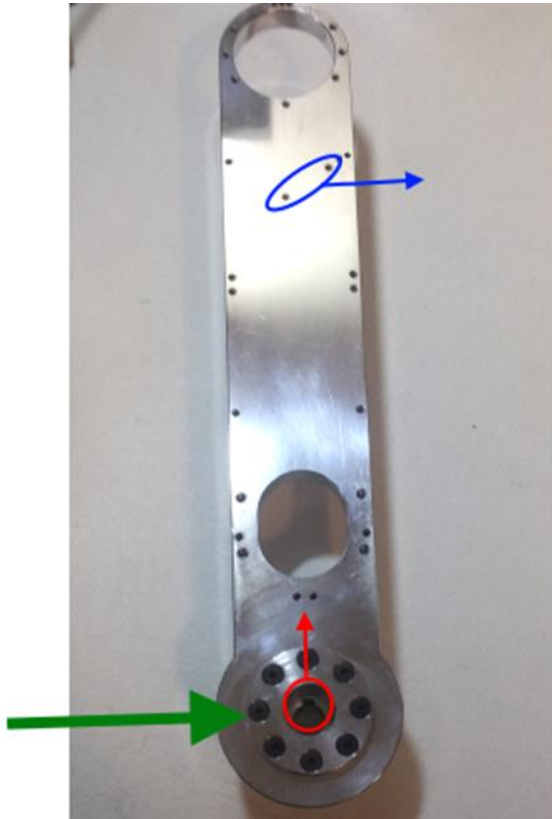

Install J2 spindle into J2 arm as shown using (8) M4x10 flat head screws. (green arrow).

Make sure J2 spindle keyway is oriented up as shown (red arrow).

Make sure J3 limit switch mounting holes are oriented to right side as shown (blue arrow).



Install #30206 bearing onto J2 spindle as shown.

(See notes on bearing fit in overview section)



Install M3x10 set screw into J2 spindle as shown but do not thread through to keyway yet.



Install J2 arm assembly into J2 turret housing and then install the other #30206 bearing from opposite side as shown.

NOTE: Apply a small amount of bearing grease to bearings prior to assembly.



Install J2 tension ring and secure with (6) M3x10 flat head screws.

Make sure tension ring is 90° to the J2 arm and that the keyway slot in tension ring aligns with keyway slot in J2 spindle.



Install (4) M4x5 set screws and tighten until there is no play in J2 bearings. These set screws set the bearing.

Move the J2 arm forward and back several times and retention screws as needed.



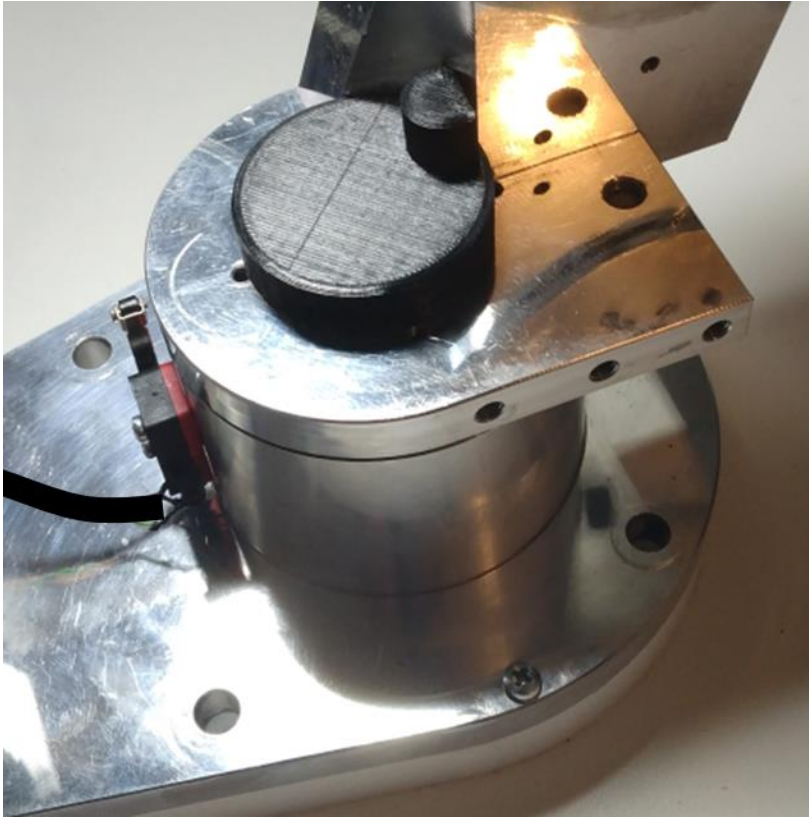

Install the 3D printed J2 Stop as shown. This part is a press fit onto the J1 platform cap screw heads.

This part prevents the J2 arm from collapsing too far.



For joint 2 cut length of continuous flex Cat6 cable to a length of 70cm long and remove outer jacket. (see overview section on jacket removal)



Remove 15cm of shielding from one end of the cable and remove 10cm of shielding from the other end. (see overview section on removing shielding)

The end with 15cm of shielding removed will be the end of the cable that is routed to the base enclosure.

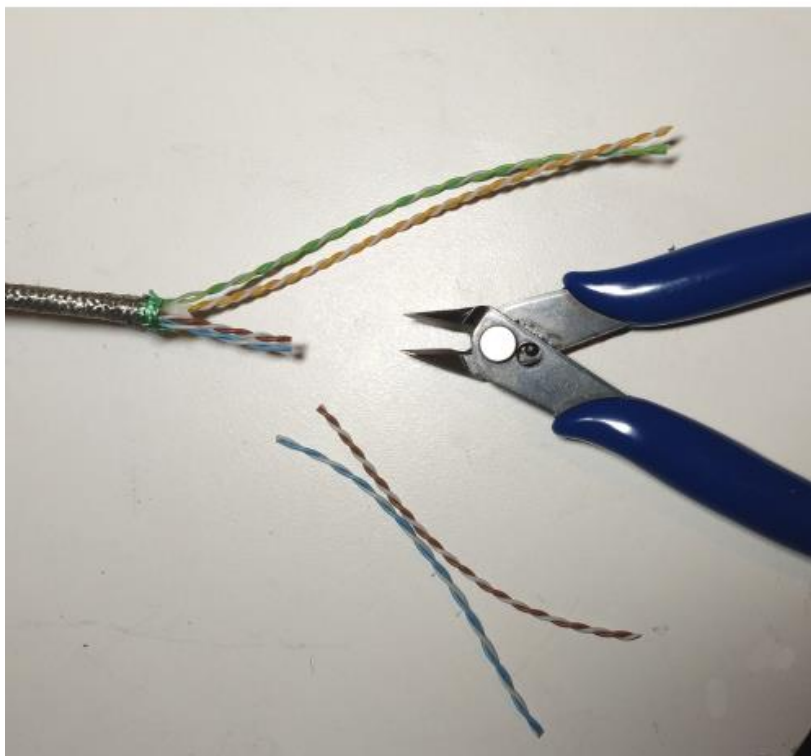

From the end of cable that has 10cm of shielding removed - cut and remove 7cm of the brown and blue twisted pairs leaving 3cm of wire exposed.



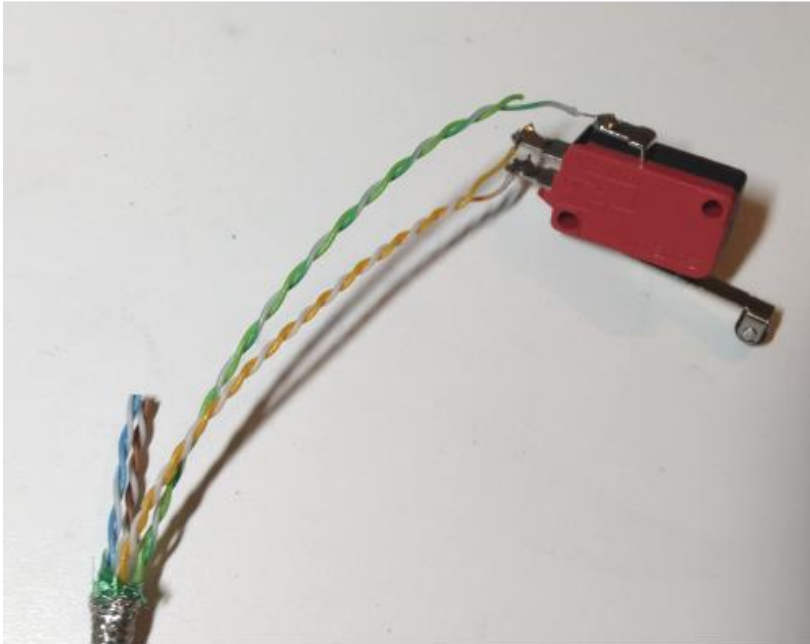

Solder orange wire to “NO” terminal of SV-166-1C25 roller tip limit switch.

Solder white with orange stripe wire to the “NC” terminal.

Solder the white with green stripe wire to the “COM” terminal.

Note: the green wire is not used.

(also see wiring diagrams in chapter 4)

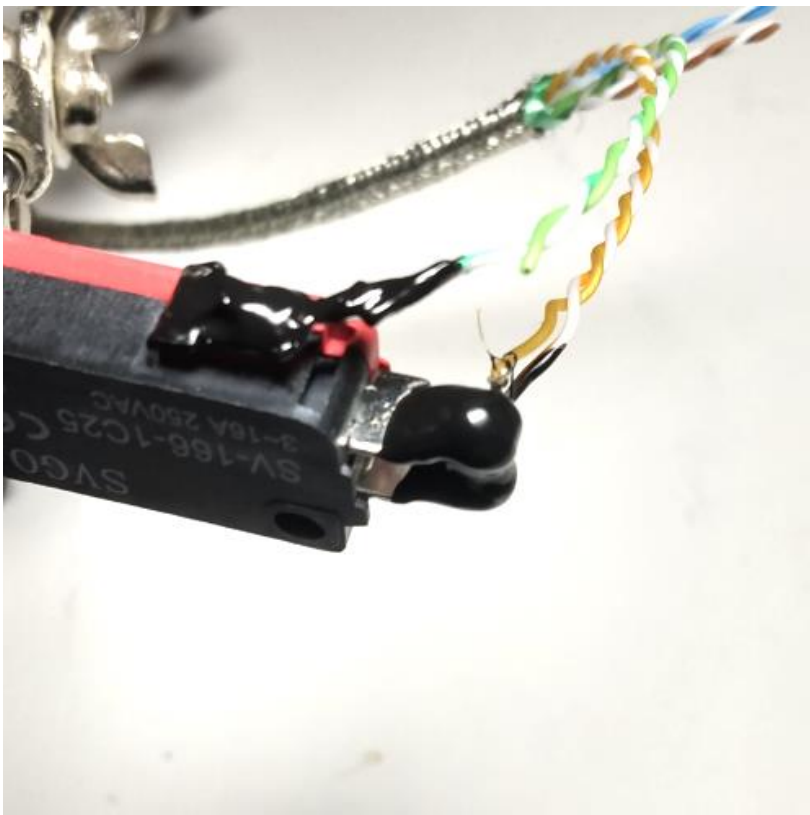

It is recommended to use liquid electrical tape to insulate terminals on limit switch.

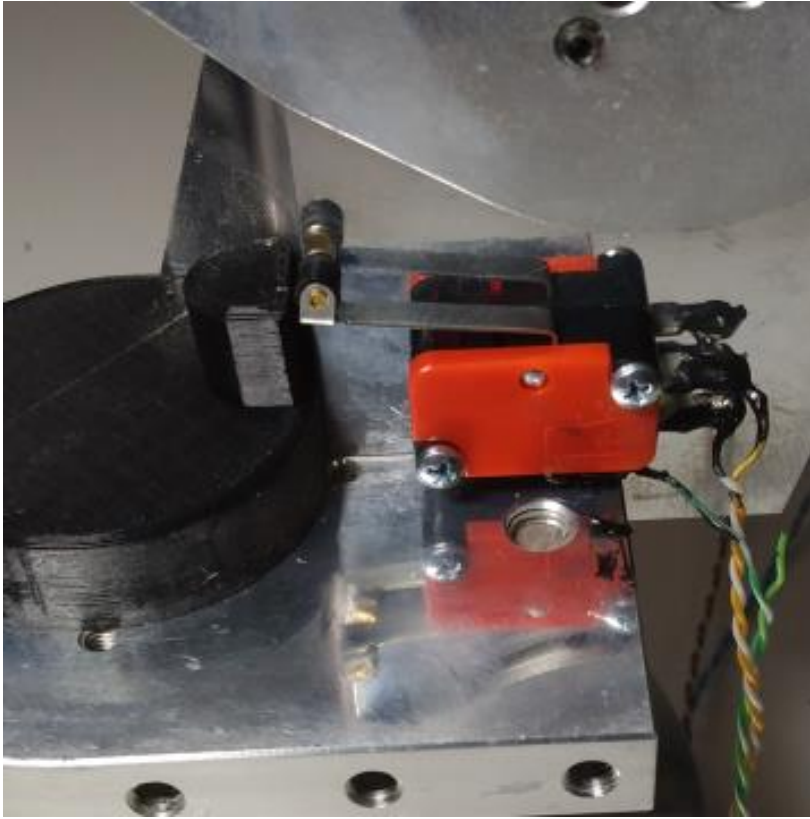

Use (2) M3x14 Philips pan head screws to secure switch to J2 housing as shown in photo.



Verify the key in the J2 motor shaft (23HS22-2804D-YGS50-AR4) is fully seated. As shown in the photo the key should be fully inserted and measure just under 16mm.

J2 MOTOR SUPPORT UPDATE

In the earlier build manual version 1.7 (12/4/25) and before; used a clamp style motor support (**left image**). The newer version is a “C” frame style mount (**right image**).



OLDER CLAMP STYLE



NEWER “C” FRAME STYLE

The following instructions page **113 through 117** will show the older clamp style – follow these instructions if you have the older style mount.

The following instructions page **118 through 123** will show the newer “C” frame style – follow these instructions if you have the newer style mount.

NOTE: THE ONLY DIFFERENCE IN USING THE NEW STYLE IS THAT IT MAKES ASSEMBLY A LITTLE EASIER AS YOU DON'T HAVE TO REMOVE THE MOTOR CAP – THERE IS NO ISSUE OR PROBLEM USING THE CLAMP STYLE MOUNT.

INSTRUCTIONS FOR CLAMP STYLE

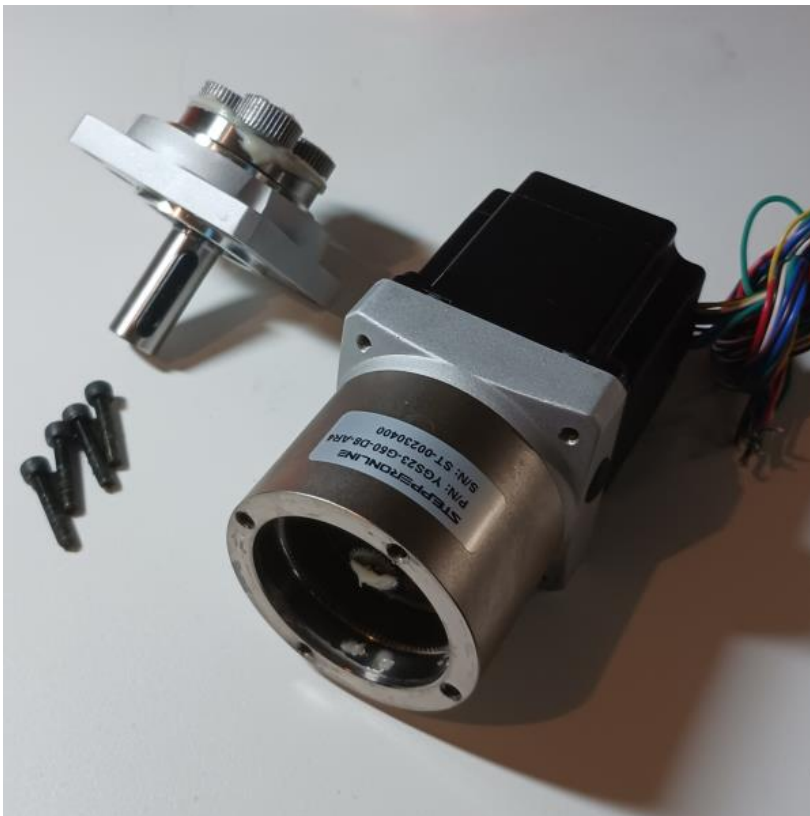

Remove the (4) M4 cap screws from the shaft side flange on the 23HS22-2804D-YGS50-AR4 gear box

Carefully remove the shaft side flange as shown.

INSTRUCTIONS FOR CLAMP STYLE

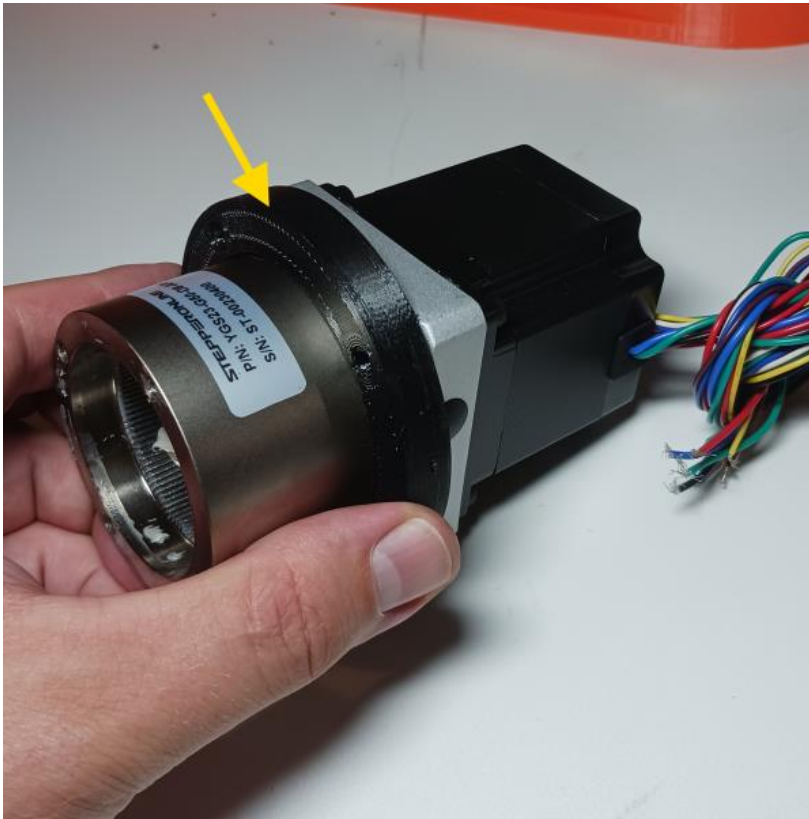

Install the 3D printed "J2 spacer YGS" onto the gearbox as shown.

Make sure the recessed or dished side of the spacer is facing toward the motor.

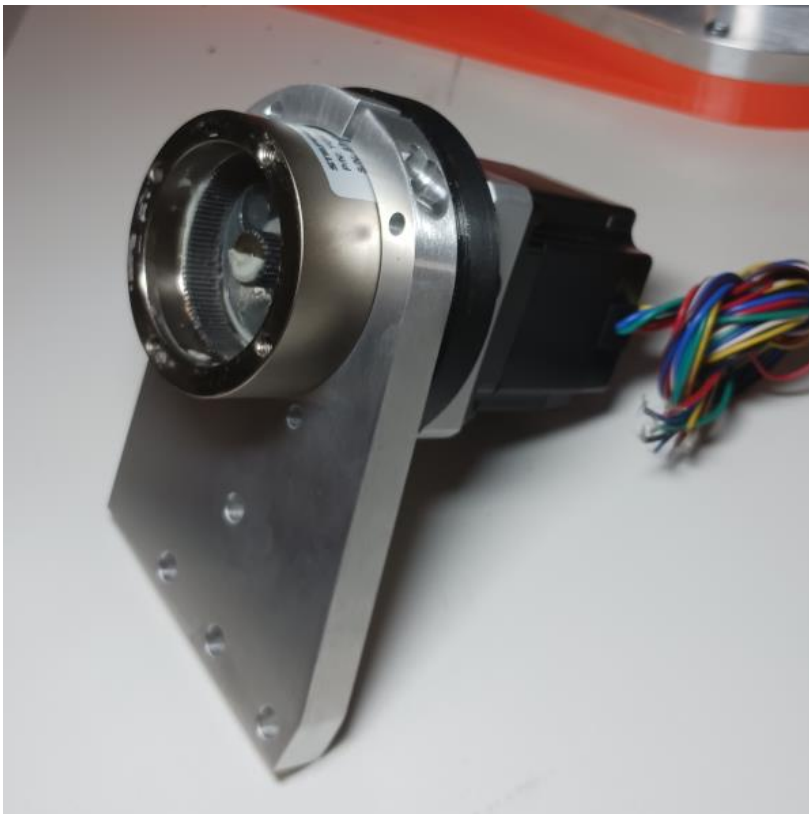

Install J2 motor mount over J2 motor gear box housing as shown.

Make sure the motor wires are oriented to the right as shown in the photo.

INSTRUCTIONS FOR CLAMP STYLE

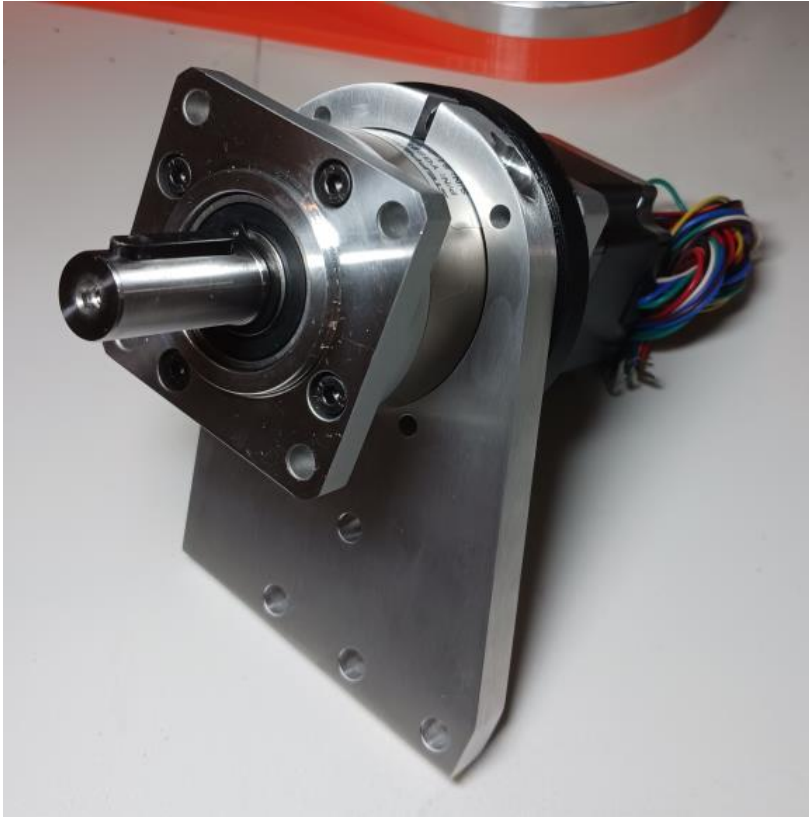

Carefully re-install the shaft side flange on to the 23HS22-2804D-YGS50-AR4 gear box as shown.

Be very careful to make sure the gears align correctly putting it back on.

Re-install and tighten the (4) M4 cap screws.

NOTE: the key is shipped separately by Stepperonline in a small zip bag – it can be difficult to press into the shaft. Use a small press or vice with soft jaws – do not hammer.

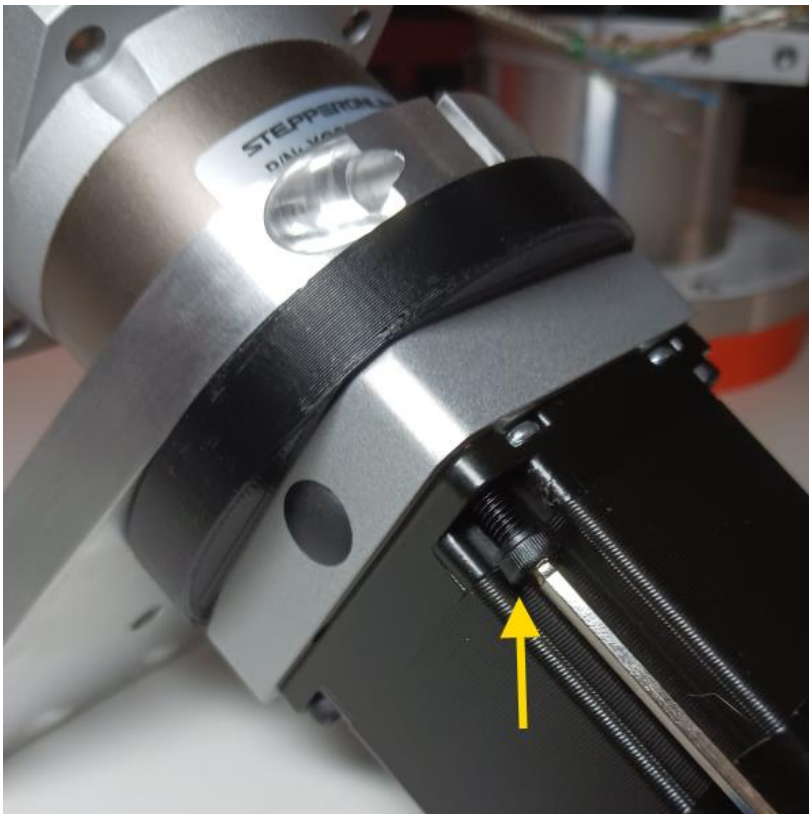

Remove one of the M4 cap screws that secures the motor to the gearbox.

INSTRUCTIONS FOR CLAMP STYLE

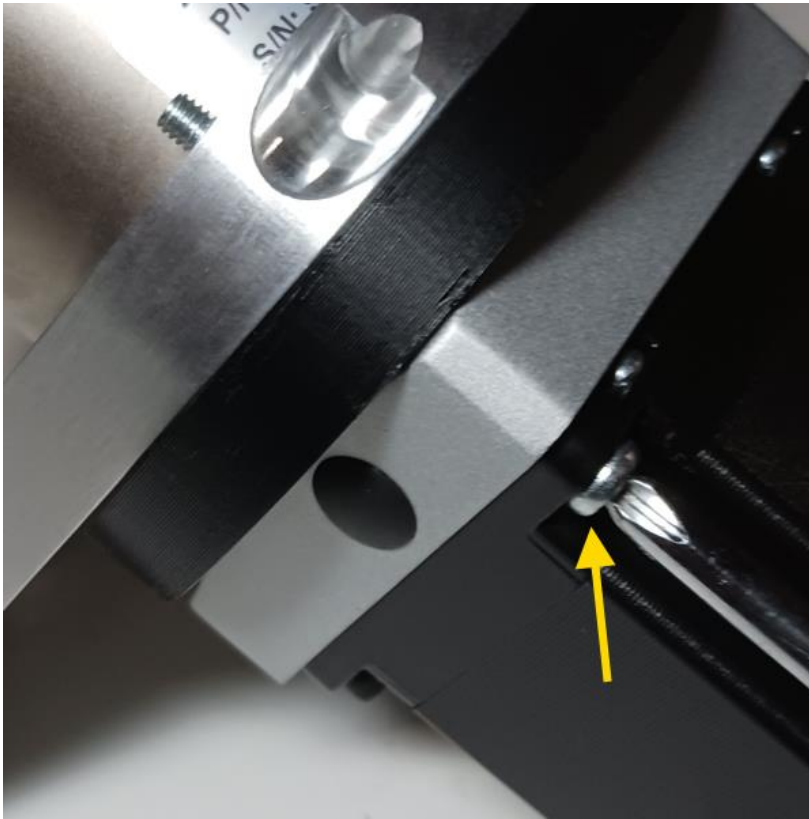

Replace the screw you just removed with a M4x45 fully threaded pan head screws.

The 45mm long fully threaded screws should protrude all the way through the J2 3D printed spacer and the J2 motor mount plate.



Install M4 washer and nut to secure motor gear box assembly to the J2 motor mount plate.

Do not tighten nut yet.

INSTRUCTIONS FOR CLAMP STYLE



Repeat the last (3) steps for the remaining motor screws so that all (4) motor mount screws have been replaced with M4x45 fully threaded pan head screws and install washers and nuts on each screw.

Do not tighten nuts yet.



INSTRUCTIONS FOR “C” FRAME STYLE



Remove one of the J4 cap screws that secures the motor to the gearbox housing.

INSTRUCTIONS FOR "C" FRAME STYLE

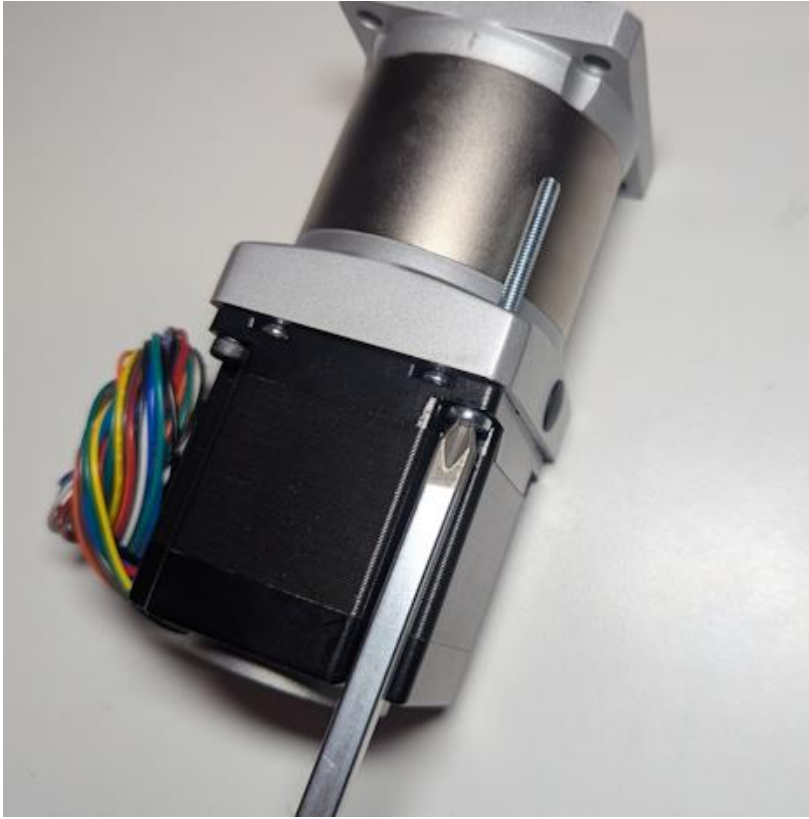

Replace the screw you just removed with a M4x45 fully threaded pan head screws.

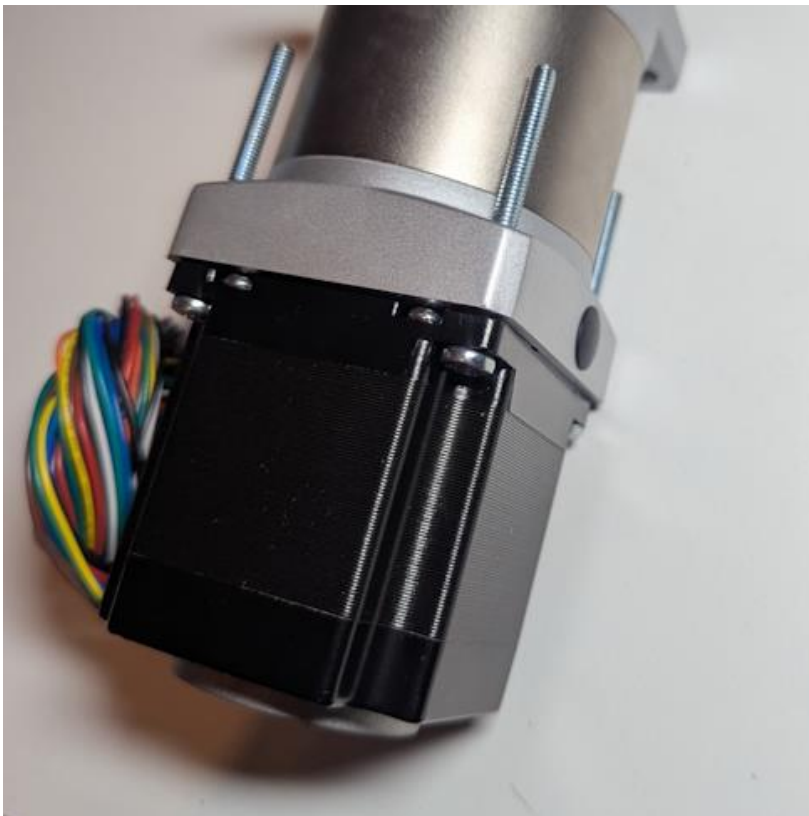

Remove the remaining (3) cap screws and replace with M4x45 fully threaded pan head screws.

All (4) fasteners securing the J2 motor to the gearbox should now be M4x45 pan head screws.

INSTRUCTIONS FOR "C" FRAME STYLE

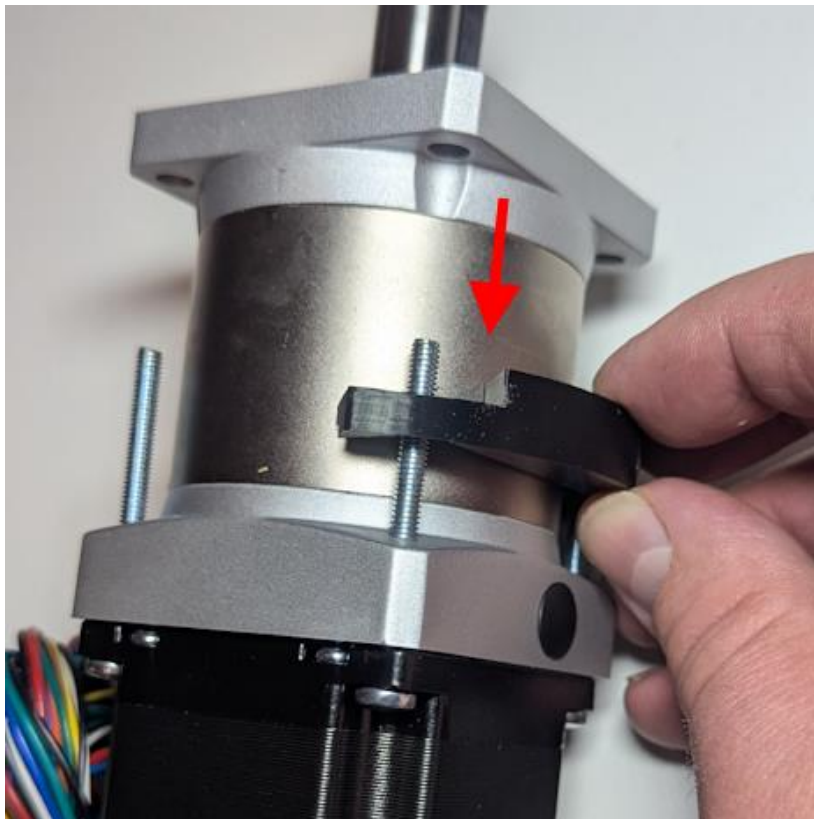

Slide J2 Motor Spacer Part 1 over M4 screws as shown. Note the motor wires are oriented on the left side of motor.



Slide J2 Motor Spacer Part 1 all the way down into position against gear box shoulder. Note the motor wires are oriented on the left side of motor.



INSTRUCTIONS FOR "C" FRAME STYLE

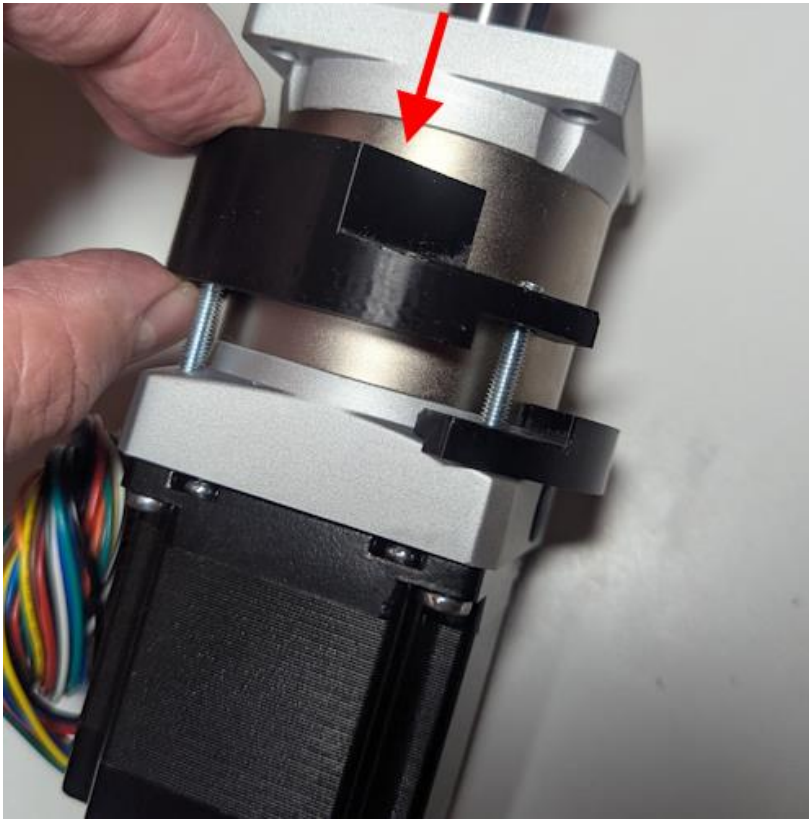

Slide J2 Motor Spacer Part 2 over M4 screws as shown. Note the motor wires are oriented on the left side of motor.

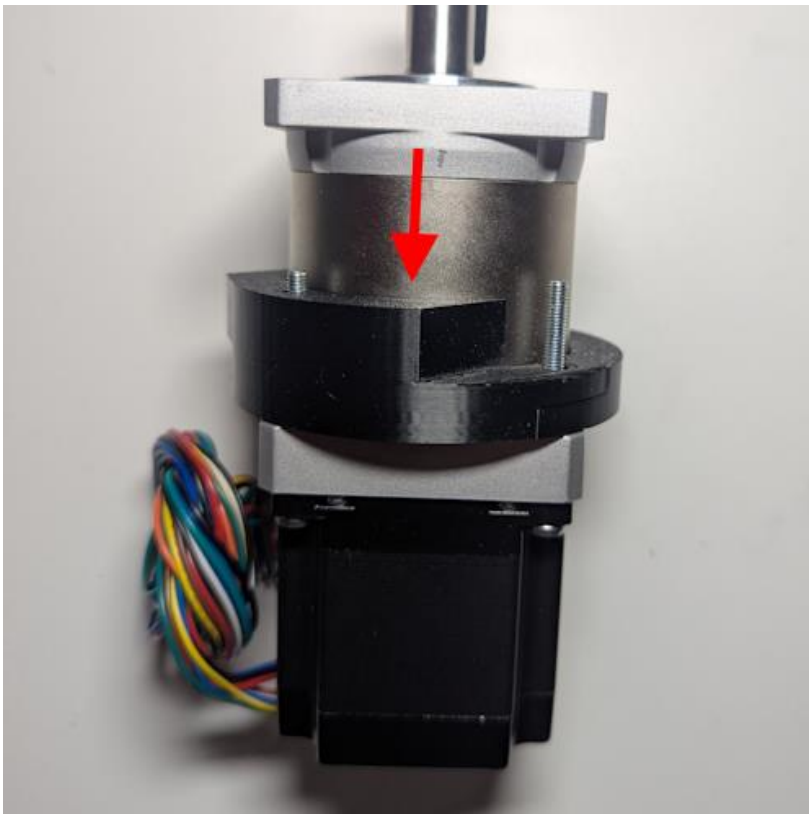

Slide J2 Motor Spacer Part 2 all the way down into position against gear box shoulder. Note the motor wires are oriented on the left side of motor.

INSTRUCTIONS FOR "C" FRAME STYLE

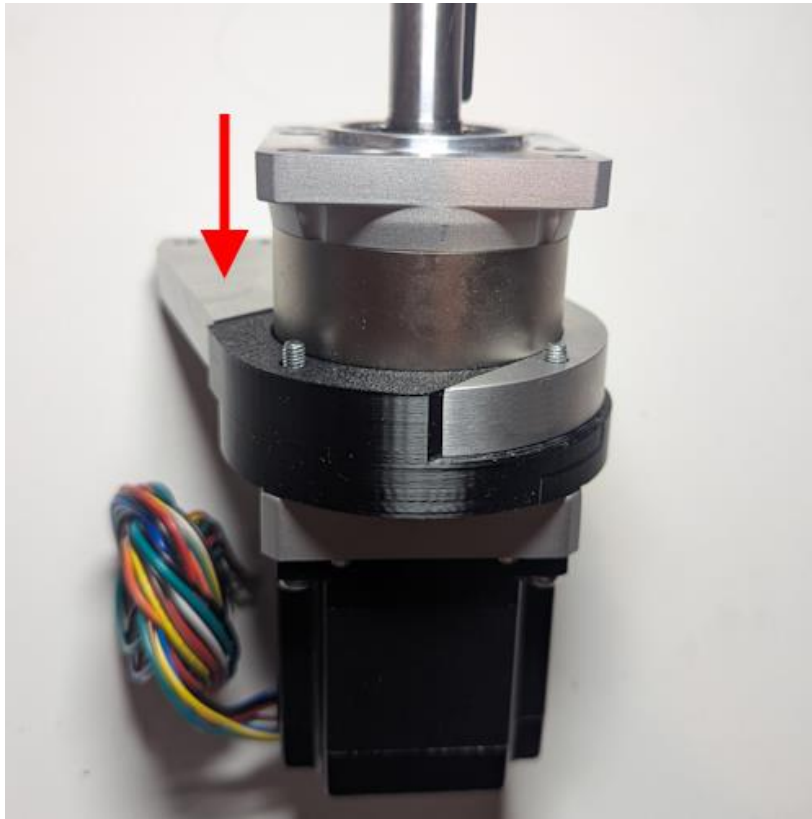

Slide J2 Motor Support over M4 screws as shown and up against the 3D printed motor spacer.

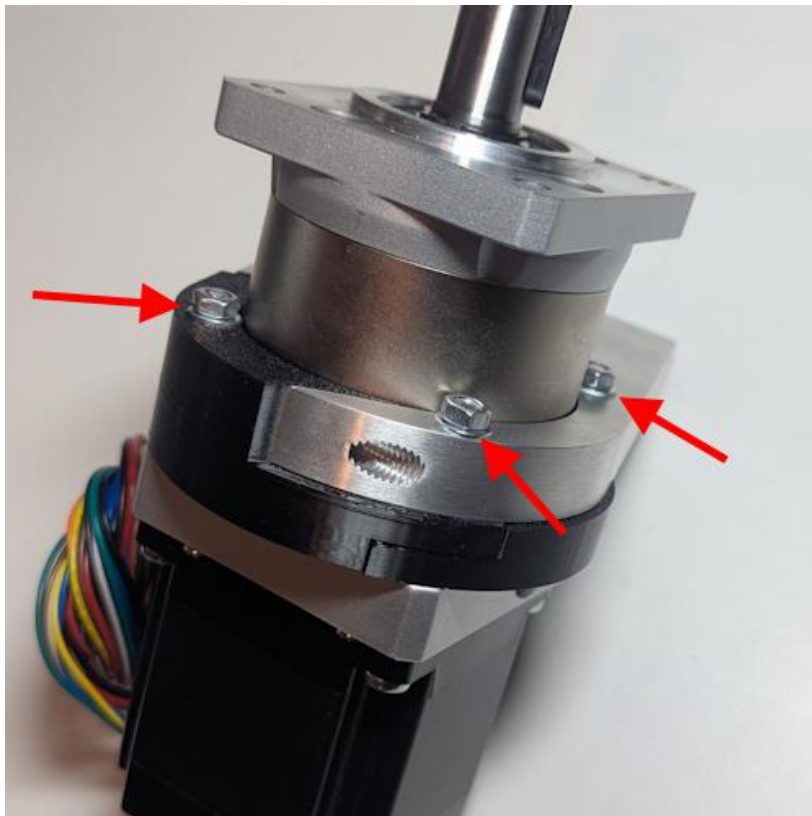

Install (4) M4 washers and nuts over each of the M4 screws and tighten.

INSTRUCTIONS FOR "C" FRAME STYLE



Once the motor, spacers and motor mount are assembled it should look like this photo.



THIS CONCLUDES THE DIFFERENCES BETWEEN THE CLAMP STYLE AND “C” FRAME STYLE MOUNTS – ALL FURTHER ASSEMBLY IS EXACTLY THE SAME REGARDLESS OF THE MOTOR MOUNT TYPE.



Install 23HS22-2804D-YGS50-AR4 gear box into J2 arm assembly as shown.

The 14mm gearbox shaft with key needs to be inserted into the J2 spindle - **make sure the key is fully pressed into shaft** – you will have trouble inserting shaft if key is not fully pressed in.

You may need to use a soft rubber mallet to insert motor, do not tap on motor, instead hold the motor firmly in one hand and use mallet to softly tap on the J2 arm and tap the entire lower assembly toward the motor that you are holding firmly (pushing toward assembly as you are tapping).

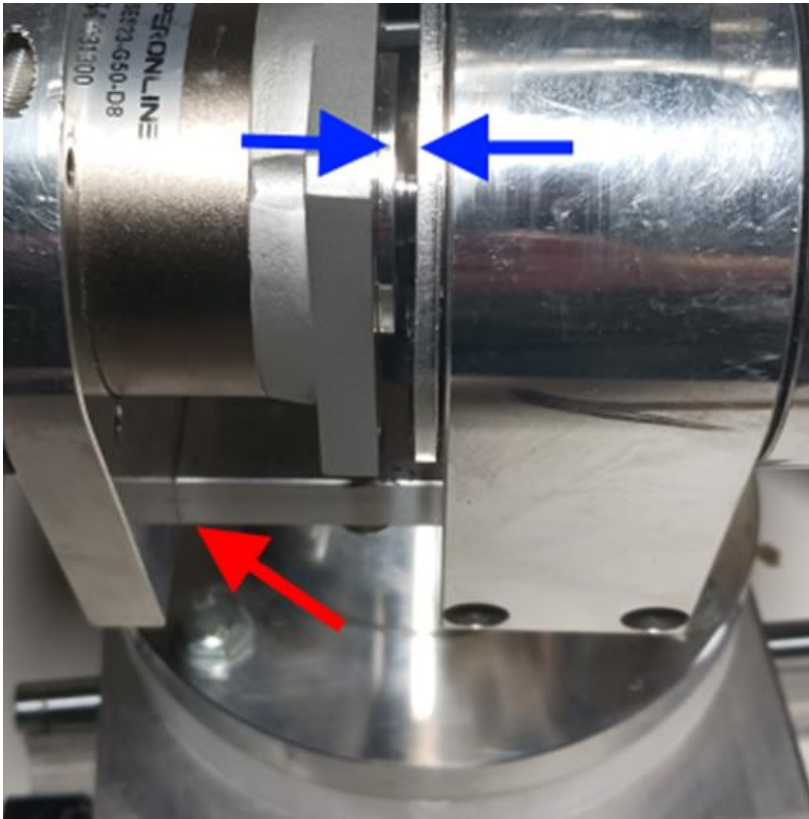

Once the gearbox is fully in place there should be an approx. 1mm gap between the J2 gearbox motor housing and the J2 tension ring as indicated by the blue arrows.

The J2 motor mount should be flush to the J1 platform as indicated by the red arrow.

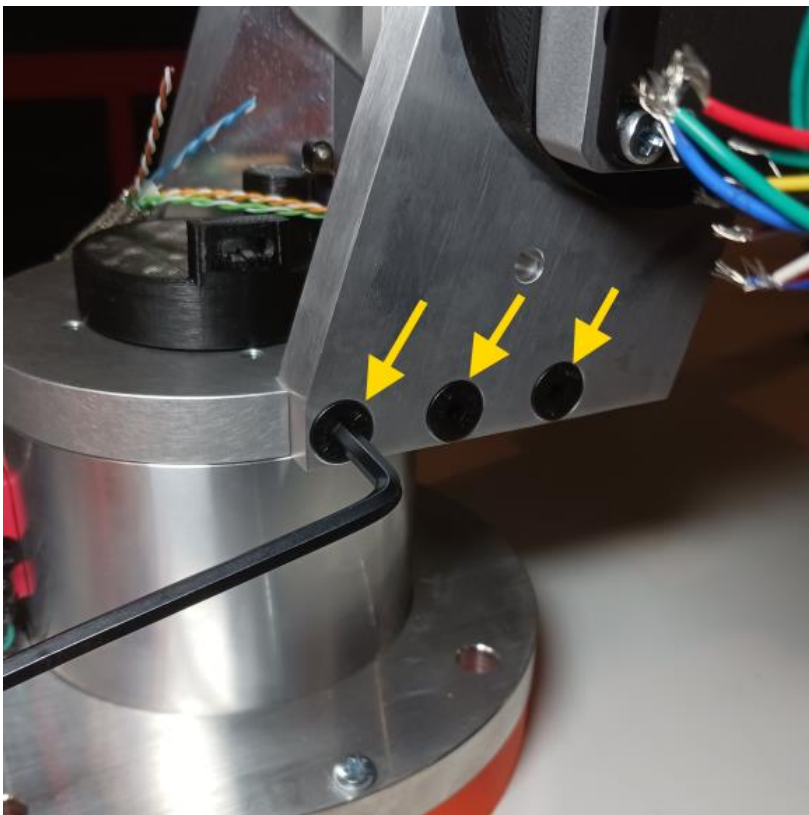

Install and tighten (3) M6x18 flat head screws securing the J2 motor mount plate to the J1 base platform.



Tighten the M3 set screw for the J2 spindle.

With the J2 arm in a vertical position you can access the set screw through the access hole in top of J2 housing.

You may need to gently move the arm by hand to get it into alignment.



Wrap a piece of tape around ends of motor wires.

This tape is just to keep the motor wires separate and help avoid any confusion after routing the wires through sheathing in next steps.



Cut length of ¼” braided sleeve to a length of 15cm long then route J2 motor and encoder wires through the sleeve.

Attach small cable tie as shown near motor (red arrow).

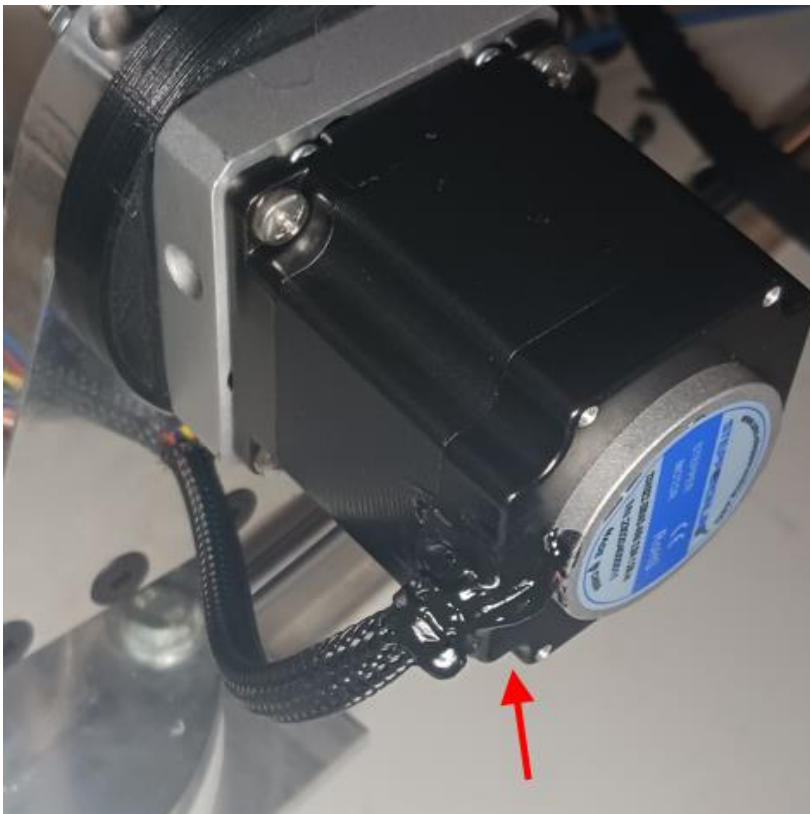

Route J2 wires through J2 motor mount plate as shown. It is recommended to coat the exposed encoder and motor wires with liquid electrical tape. (red arrow)

Applying the liquid electrical tape can also be done later after fully testing the robot electrically.

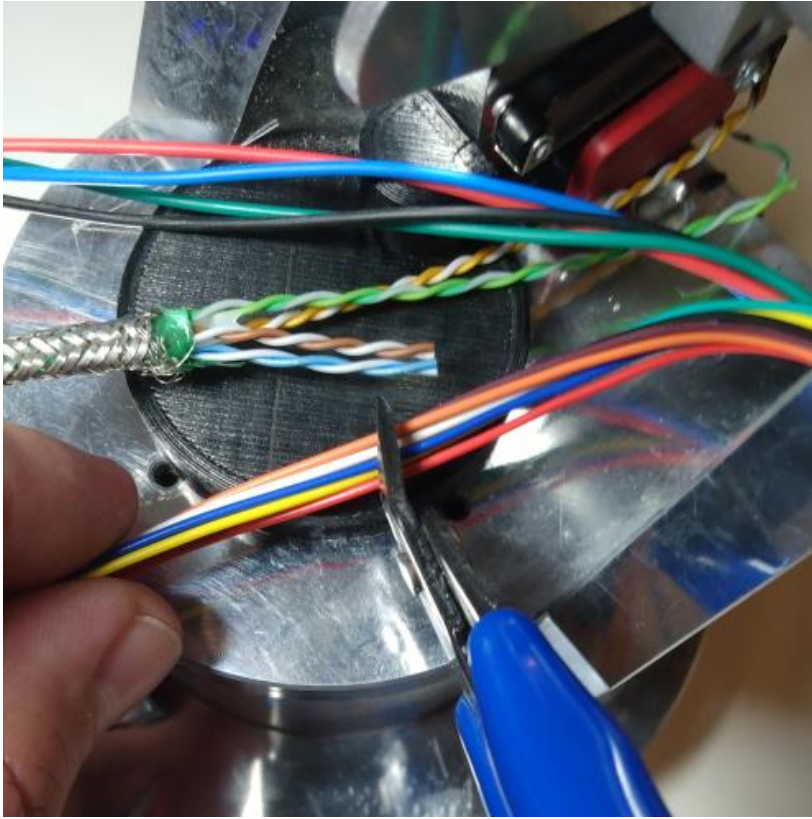

After routing J2 wires through the motor mount plate separate the J2 motor wires from J2 encoder wires then cut the encoder wires to a length where they slightly overlap the brown and blue twisted pairs as shown in the photo.

NOTE: save the remainder encoder wires as some of them will be used in chapters 3 and 4.

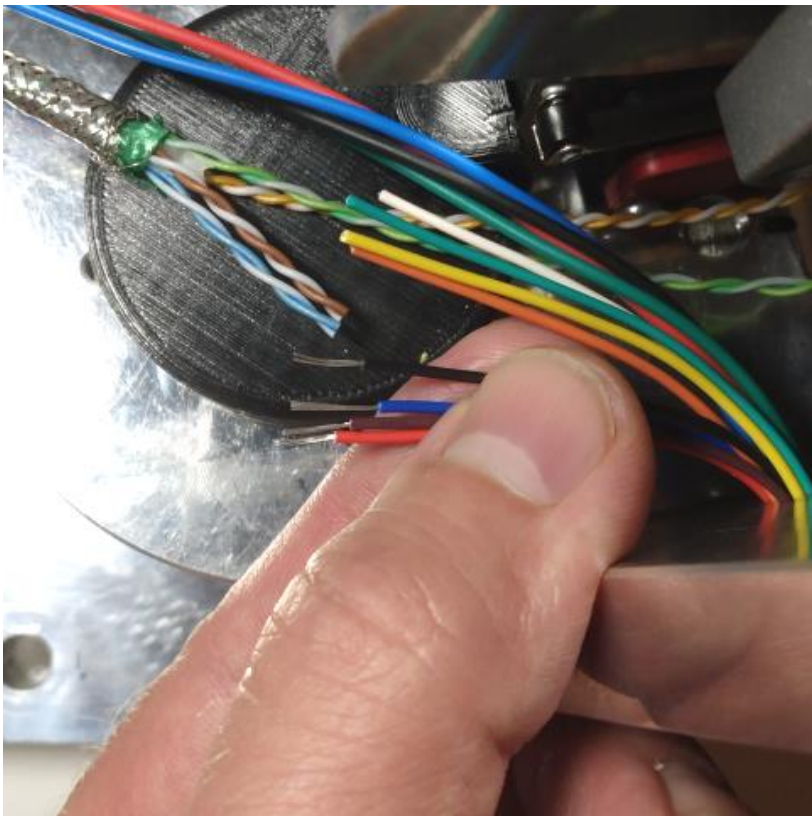

Use wire strippers to strip end of the red, black, brown and blue encoder wires.

Note: only these 4 encoder wires will be used.

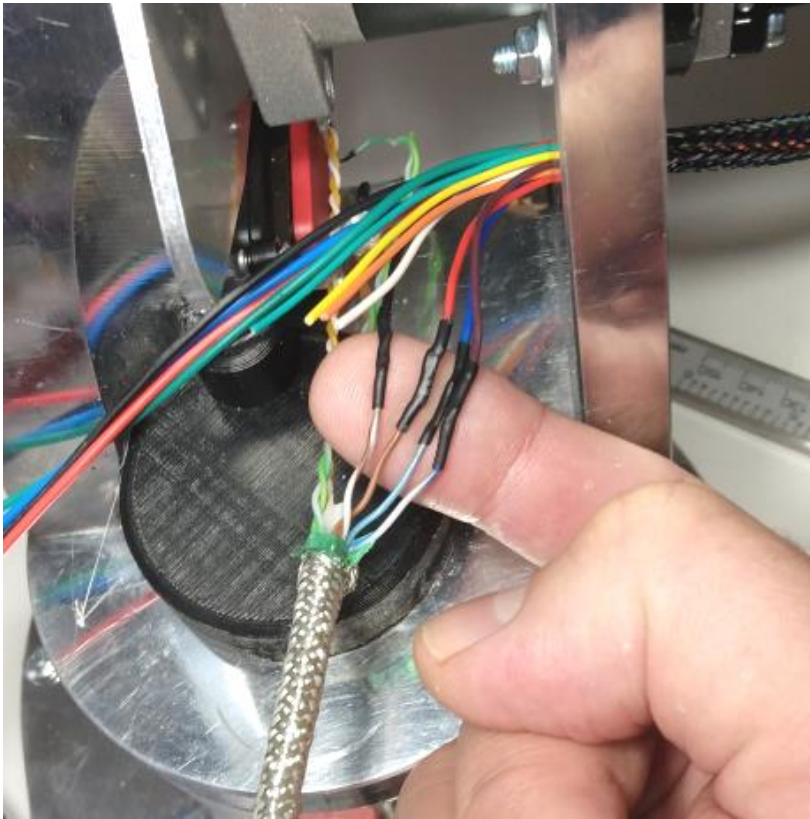

Solder and heat shrink the connection from the J2 encoder to the Cat6 cable as follows:

Encoder red wire to the cable brown wire.

Encoder black wire to the cable white – brown stripe wire.

Encoder brown wire to the cable white – blue stripe wire.

Encoder blue wire to the cable blue wire.



Cut Red, Black, Blue & Green 20awg wires to a length of 34cm long.

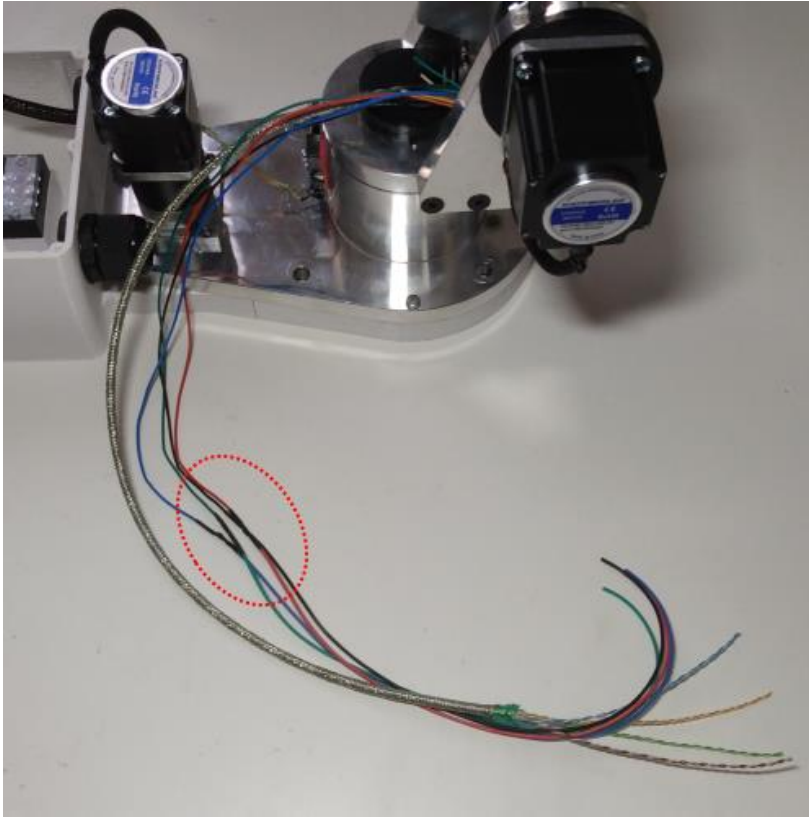

Solder and heat shrink 34cm long extension wires to the J2 motor wires as shown.

Be sure to match colors so that red goes to red and so on.

With the J2 motor wires extended the motor wires and Cat6 cable for J2 should now be the same length.

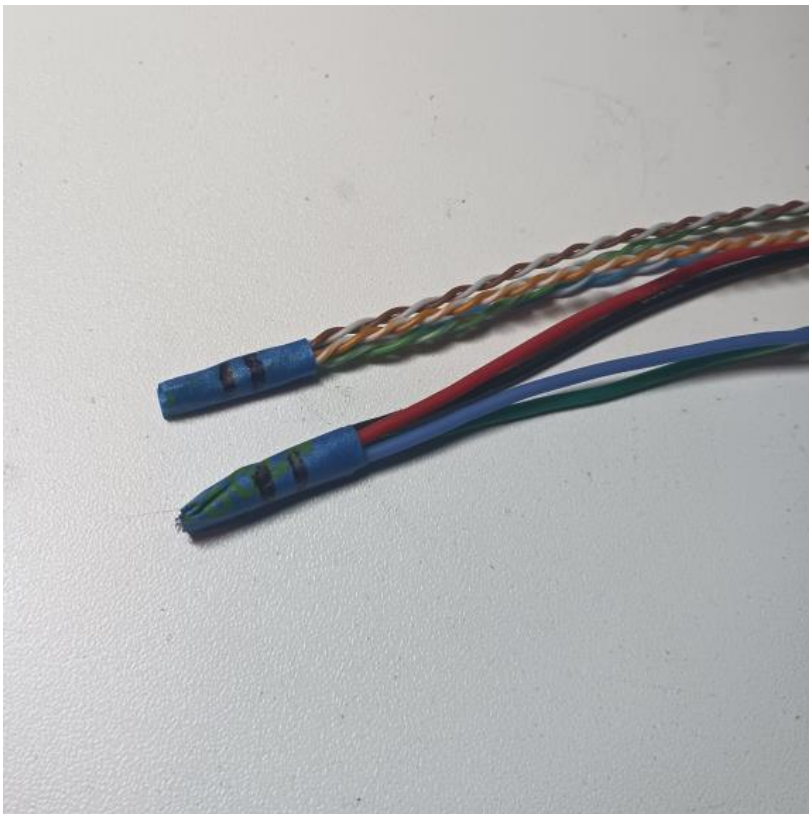

Wrap ends of J2 motor wires and the J2 Cat6 cable wires with wraps of tape and then use a marker to put (2) stripes on each so that you will know these are for J2 when wires have been routed inside enclosure.



Press (1) #30204 bearing race into the J3 bearing cup.

(See notes on bearing fit in overview section)



Secure J3 bearing cup and race to end of J2 arm using (6) M3x20 flat head screws.



Install 8mm keyed shaft with 2x2mm keystock into J3 spindle.

- 8mm shaft should be 50mm long.
- 2x2mm keystock should be 50mm long.

Secure shaft and key in position with M3x4 set screw



Install 35x52x4 thrust bearing and washers onto J3 spindle as shown.

NOTE: don't forget to add a small amount of grease to needle bearings.



Insert J3 spindle and bearing assembly into J2 arm as shown.



While holding the J3 spindle and bearing in place insert #30204 bearing over J3 spindle shaft as shown.

(See notes on bearing fit in overview section)



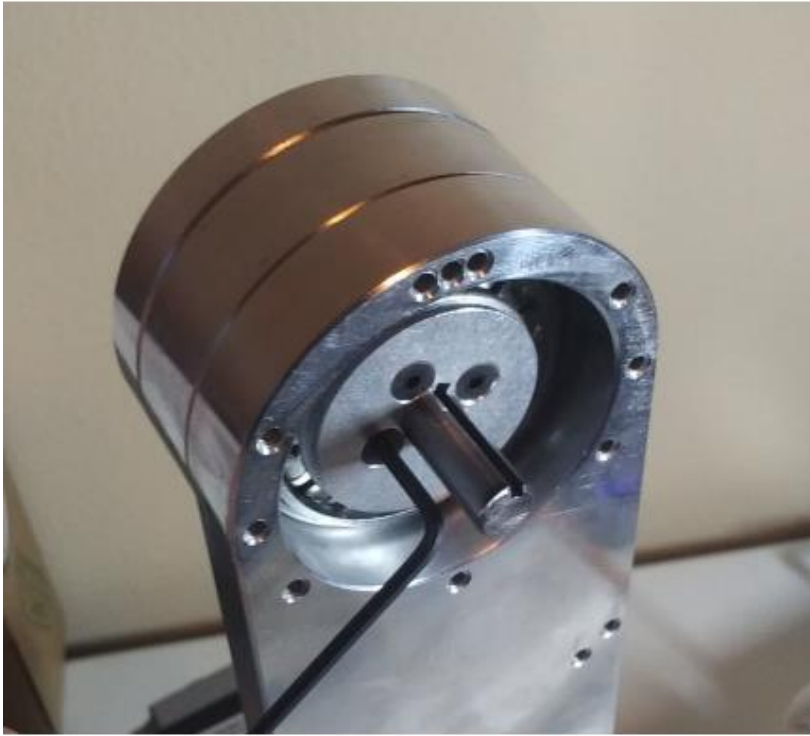

Install J3 spindle retainer and secure with (4) M3x10 flat head screws.

Tension screws so that there is no play in bearing but not too tight that the J3 shaft does not rotate smoothly.

NOTE: Rotate the spindle several times to run the bearings in and re-tension the screws as needed.

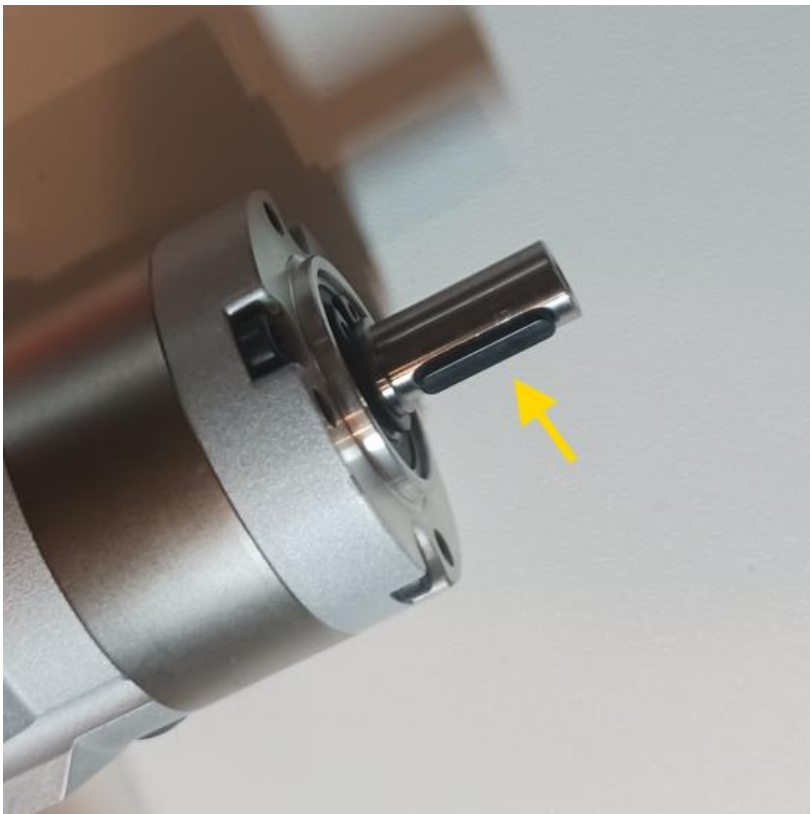

Install 3mm key into J3 (SKU: 17HS15-1684D-EG50-AR4) motor shaft as shown.

The motor keys are shipped from Stepperonline in a small zip bag supplied with the motor paperwork and manuals.

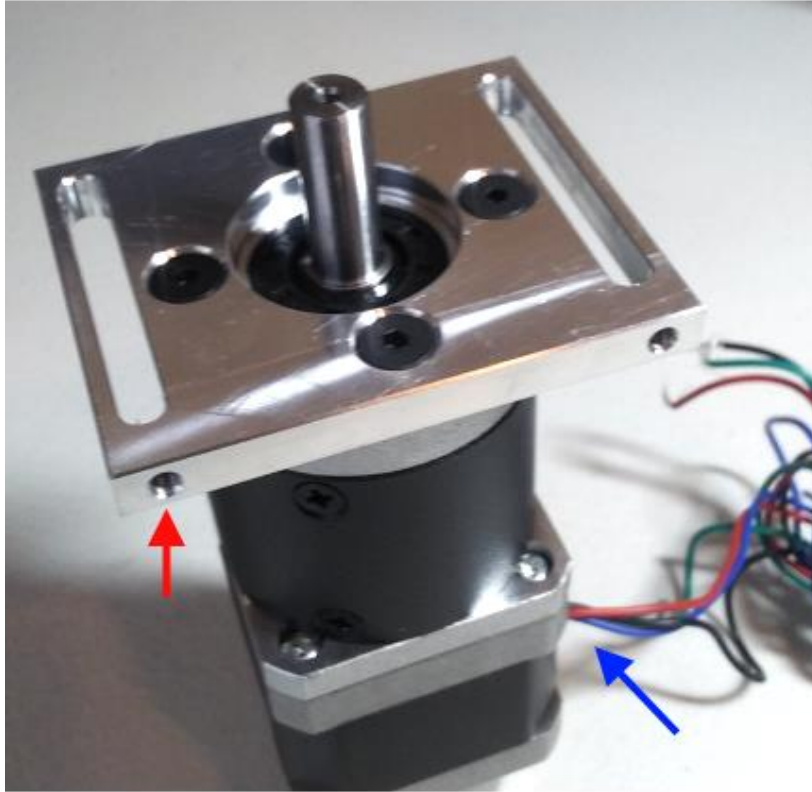

Install J3 motor mount to J3 motor using (4) M4x10 flat head screws.

Make sure that the tension holes (red arrows) are 90° to the motor wires (blue arrows) in the orientation shown in the photo.

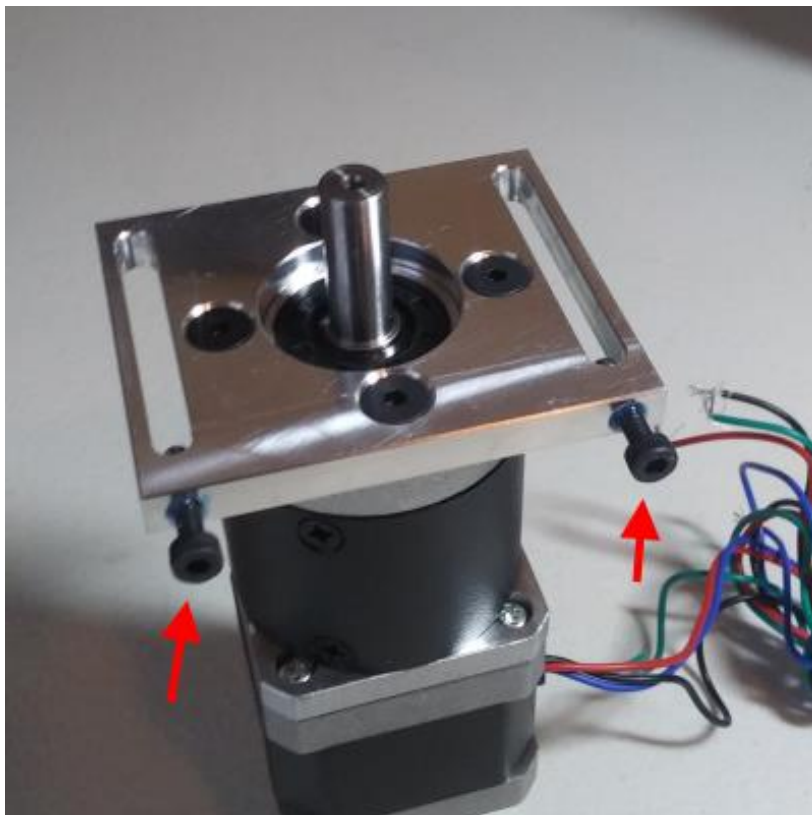

Install (2) M3x14 cap head screws into tension slot holes on J3 motor mount.



Install the Long Shoulder HTD-20 pulley on to the J3 motor shaft as shown.

Make sure the Key is installed on the motor shaft and aligned to the pulley keyway.

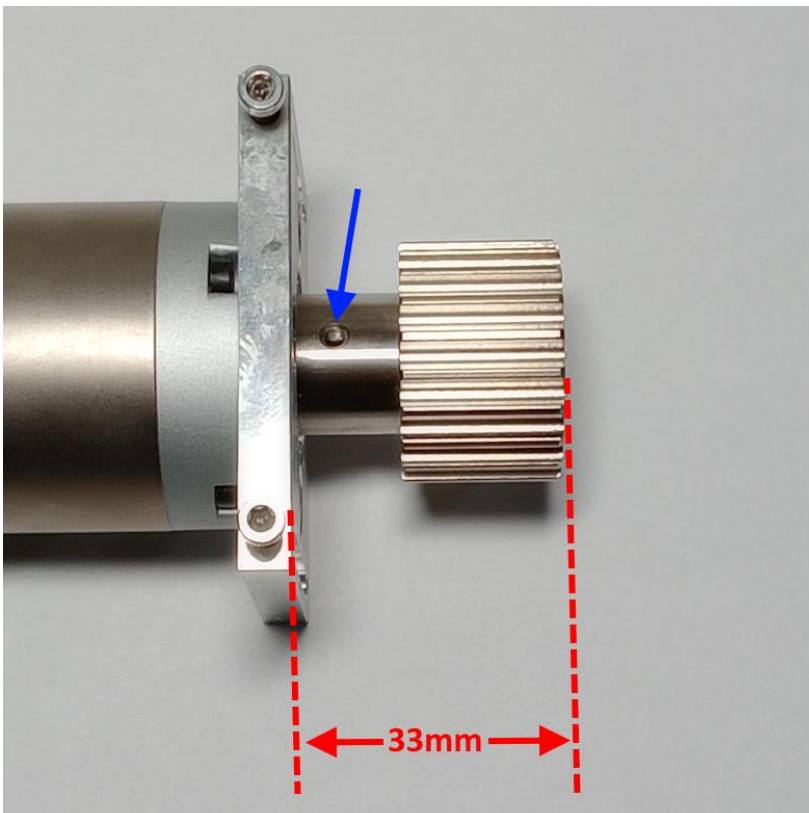

Adjust the pulley depth on the shaft so that the distance from the surface of the motor mount to the top of the pulley is 33mm as shown in the photo.

After the pulley is at the correct depth install and tighten M3x4 set screw in the pulley collar (blue arrow)

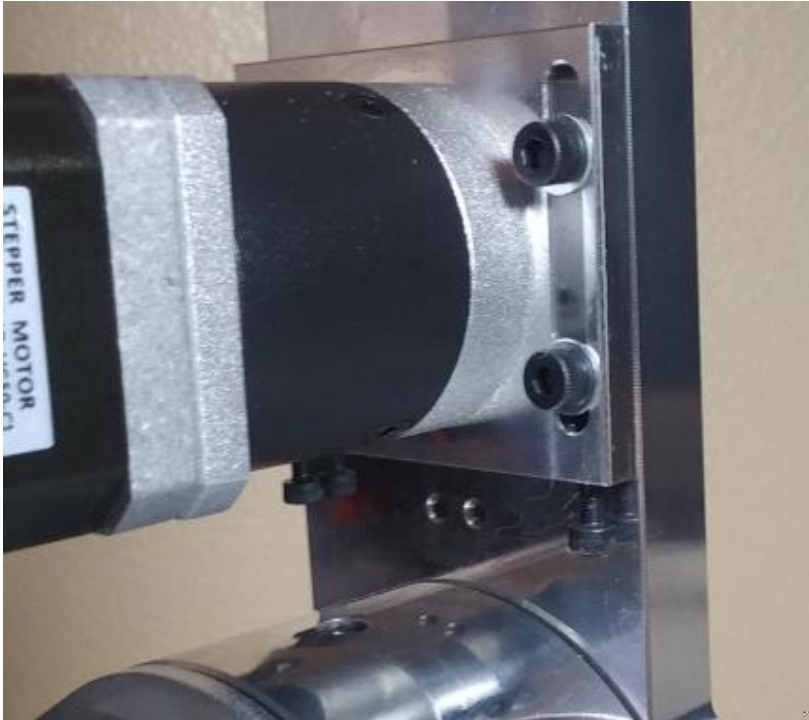

Secure J3 motor assembly to J2 arm using (4) M4x20 socket head cap screws and (4) washers.

Make sure the wire pigtail is facing to the left or toward the rear of the robot assembly.

Make sure the socket head cap screws securing the motor to the arm are slightly loose so that motor can slide to apply tension in a later step.

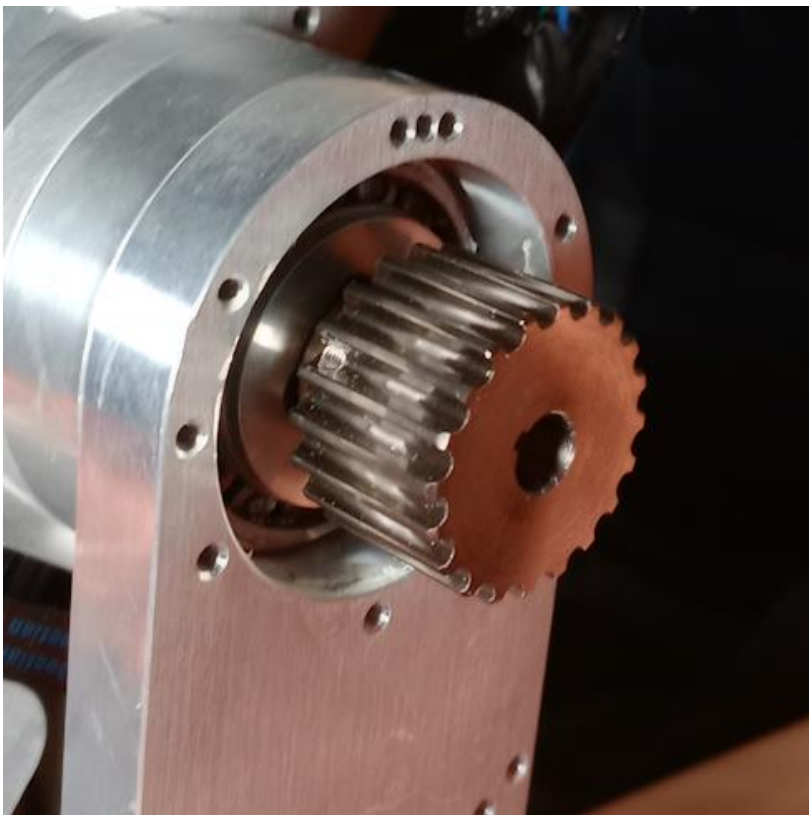

Install the short shoulder HTD-20 pulley onto the J3 8mm shaft.

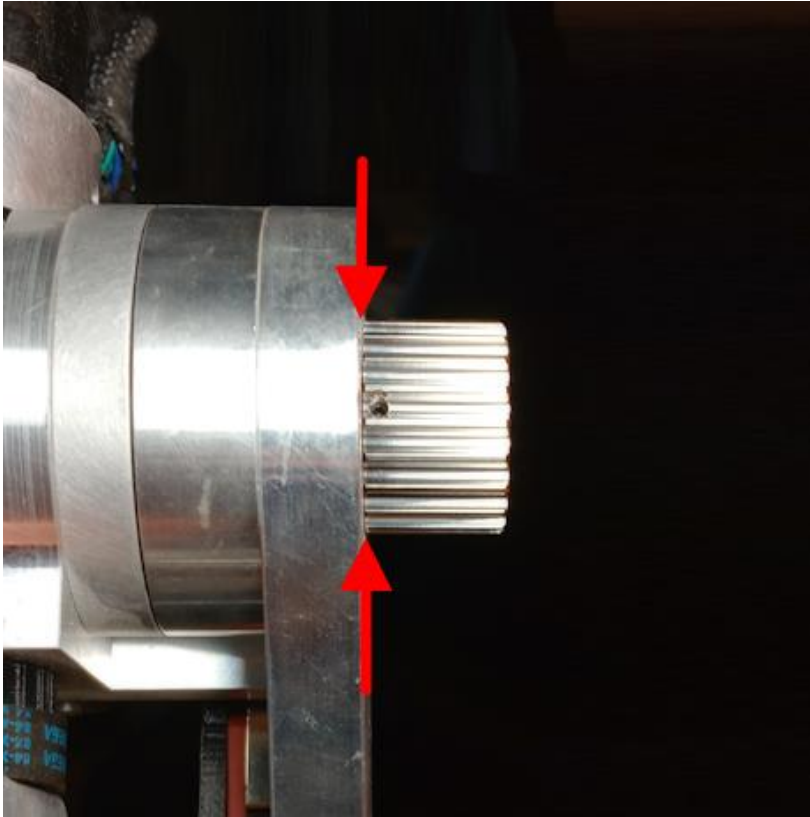

Note that the left or inside edge of pulley should be flush with J2 plate as indicated by the red arrows.

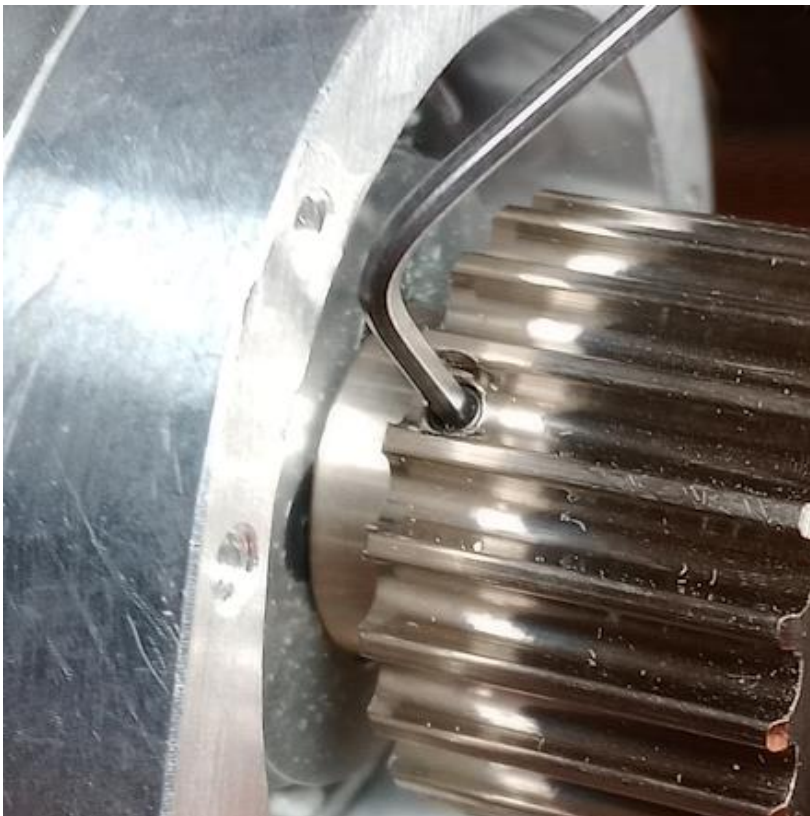

Install and tighten M3x3 set screw in threaded hole on side of pulley as shown.



- ▶ Install HTD-550M belt over both HTD-20 pulleys as shown.



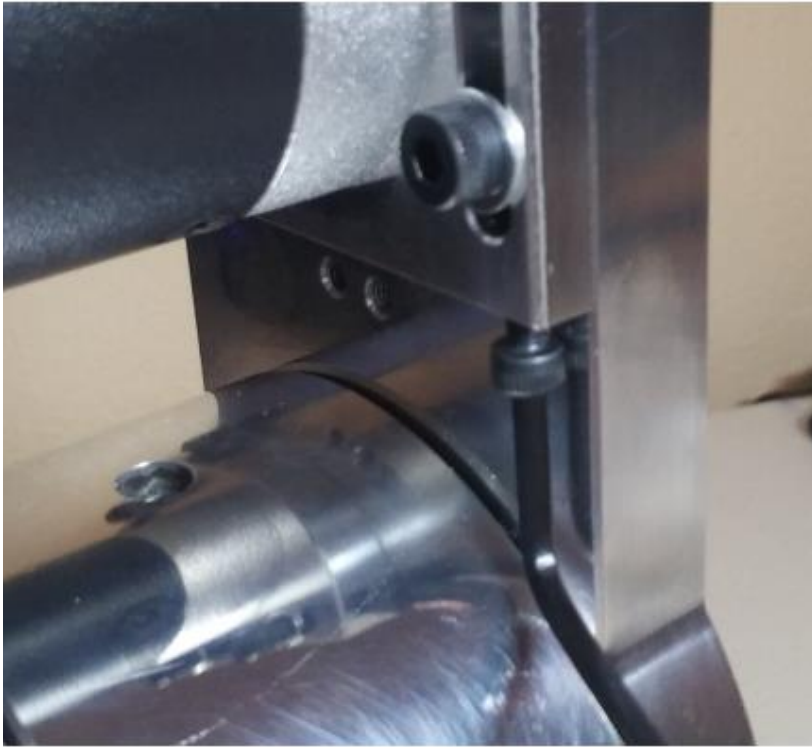

Tighten M3 tension screws until there is good tension on the belt.

After belt is tensioned, finish securing the J3 motor mount by tightening the (4) M4x20 motor mount screws.

This video shows the expected deflection or tension for joint 3.

[Joint 3 Video](#)

If joint 3 is too loose please apply additional belt tension.



For joint 3 cut length of continuous flex Cat6 cable to a length of 120cm long and remove outer jacket. (see overview section on jacket removal)



Remove 15cm of shielding from one end of the cable and remove 25cm of shielding from the other end. (see overview section on removing shielding)

The end with 15cm of shielding removed will be the end of the cable that is routed to the base enclosure.

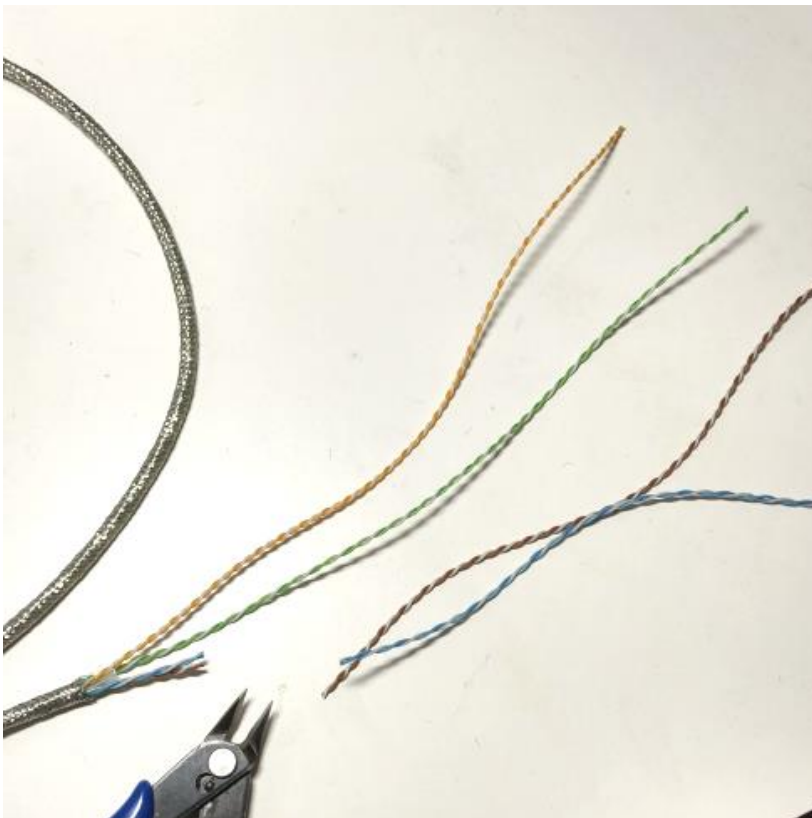

From the end of cable that has 25cm of shielding removed - cut and remove 22cm of the brown and blue twisted pairs leaving 3cm of wire exposed.

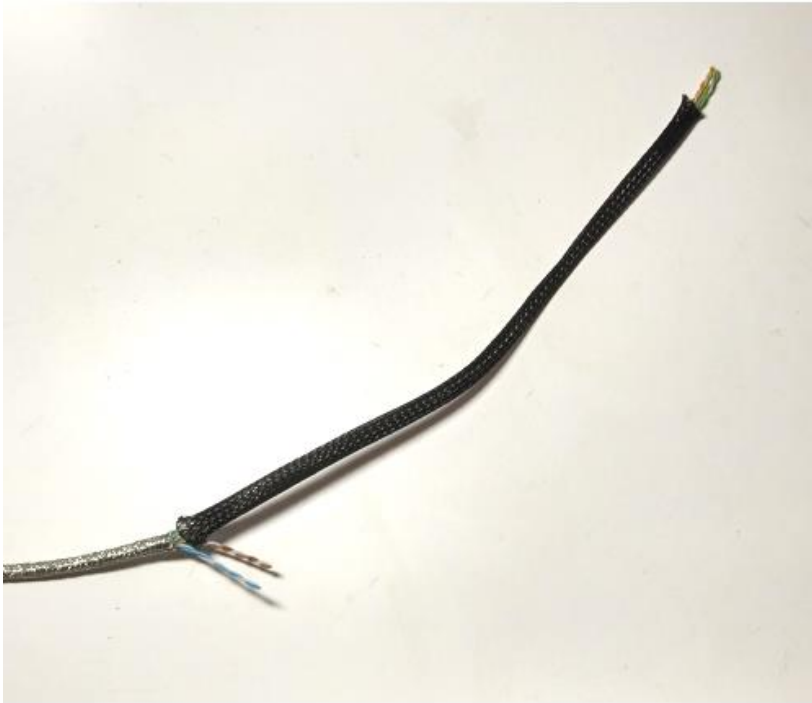

Cut length of ¼” braided sleeve to a length of 23cm long then route green and orange twisted pairs through sleeve as shown.

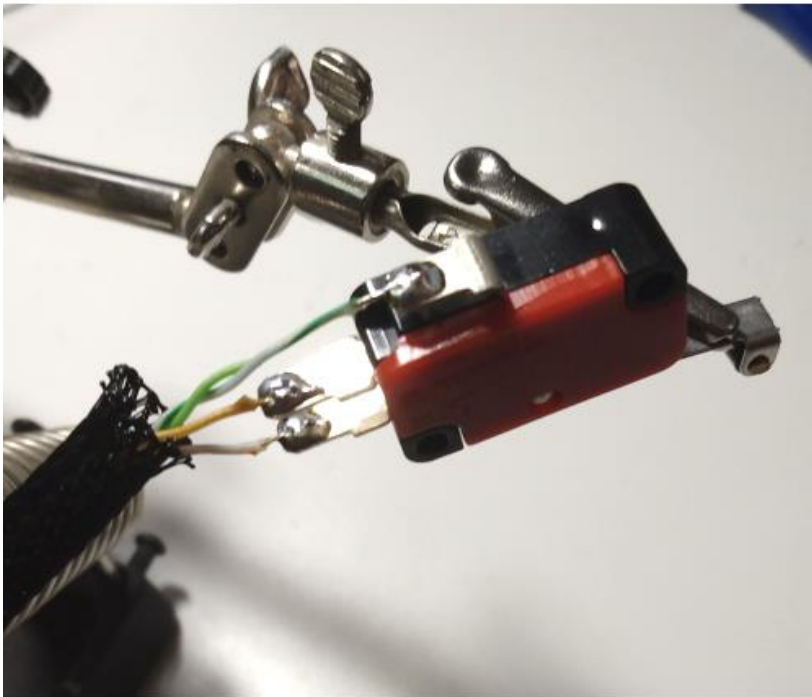

Solder orange wire to “NO” terminal of SV-166-1C25 roller tip limit switch.

Solder white with orange stripe wire to the “NC” terminal.

Solder the white with green stripe wire to the “COM” terminal.

Note: the green wire is not used.

(also see wiring diagrams in chapter 4)

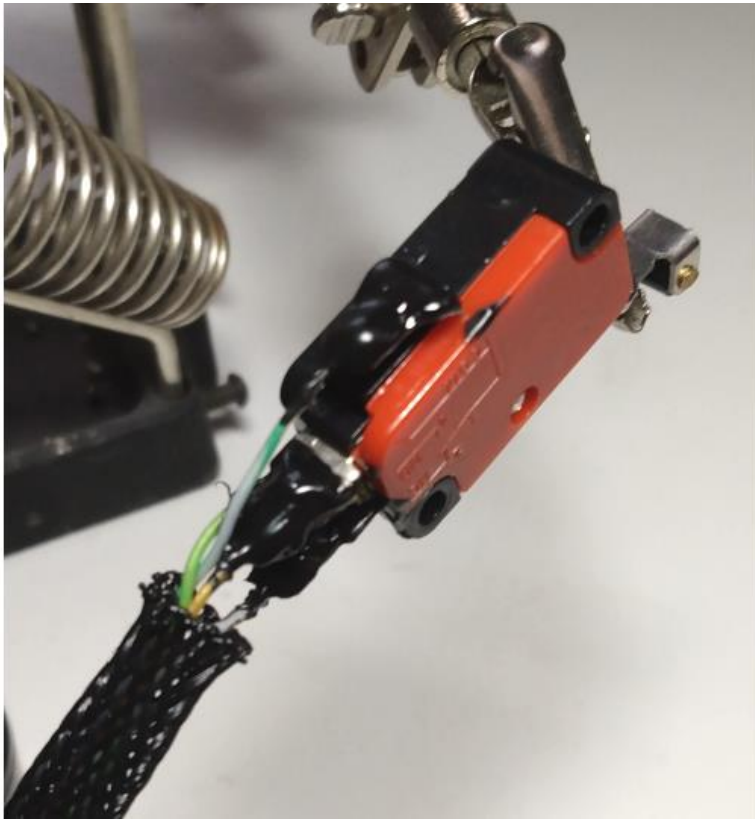

It is recommended to use liquid electrical tape to insulate terminals on limit switch.



Insert the J3 limit switch into the 3D printed J3 Stop as shown in the photo.



Use (2) M3x20 Philips pan head screws to secure J3 limit switch with J3 Stop onto J2 arm as shown.

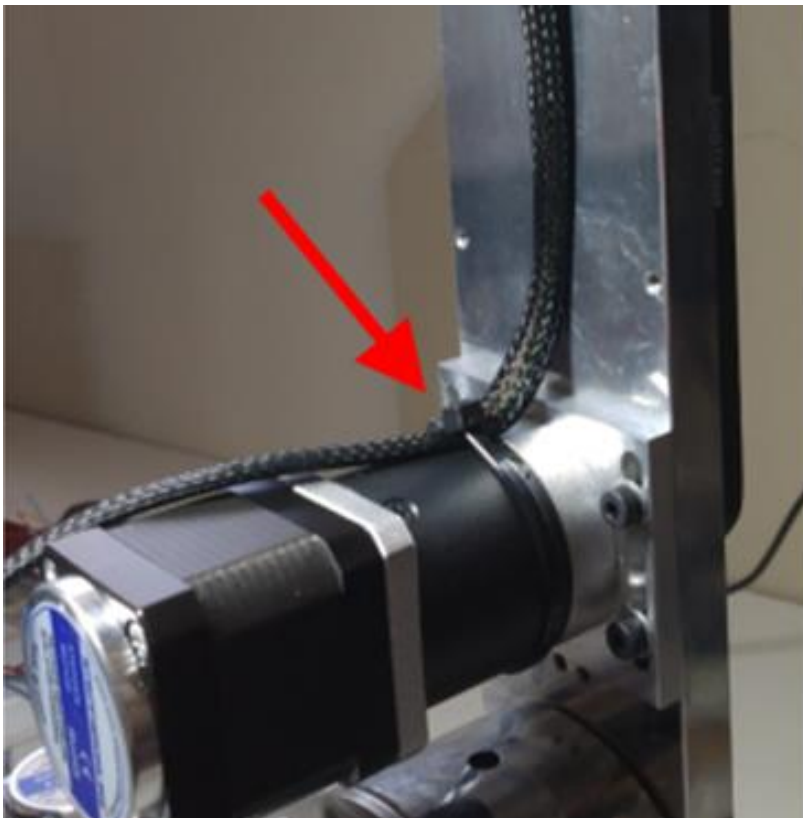

Use cable tie to secure J3 limit switch wire and braided sleeve to J3 gear box (red arrow).

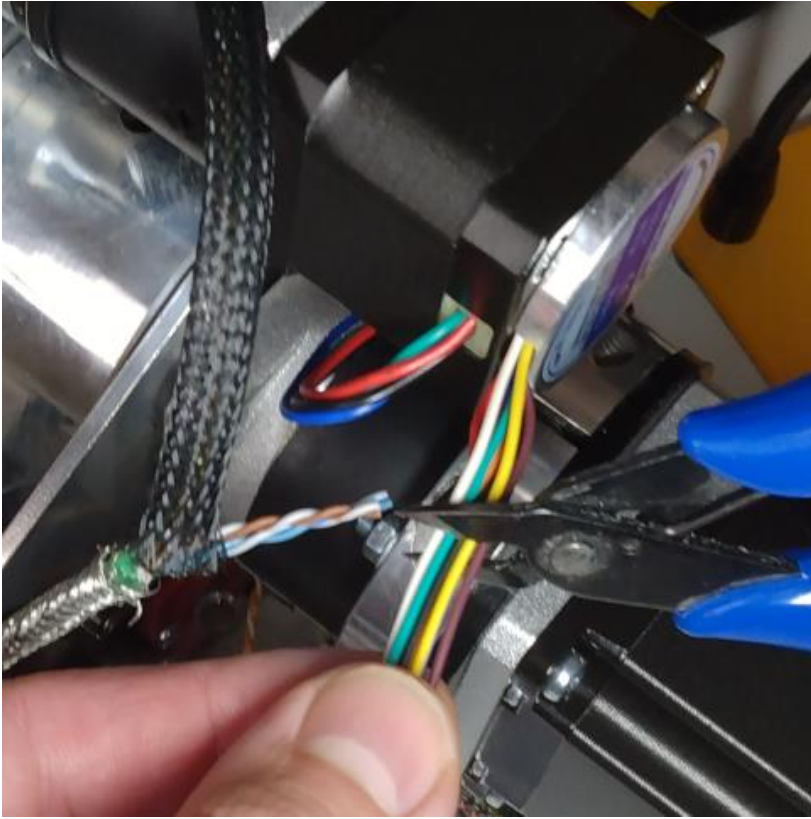

Cut the J3 encoder wires to a length of 4cm.

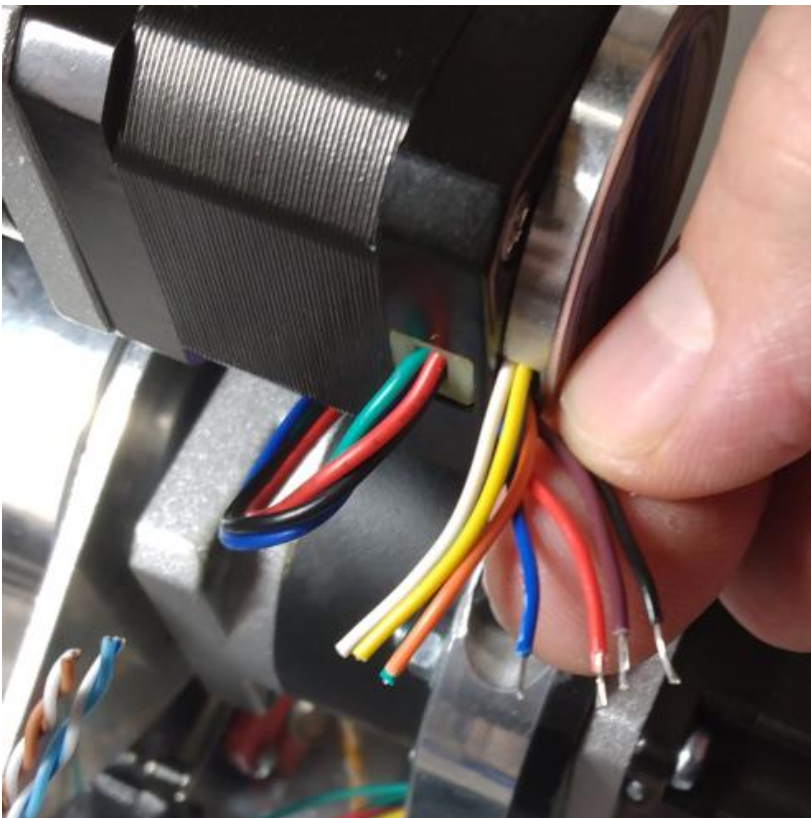

Use wire strippers to strip end of the red, black, brown and blue J3 encoder wires.

Note: only these 4 encoder wires will be used.

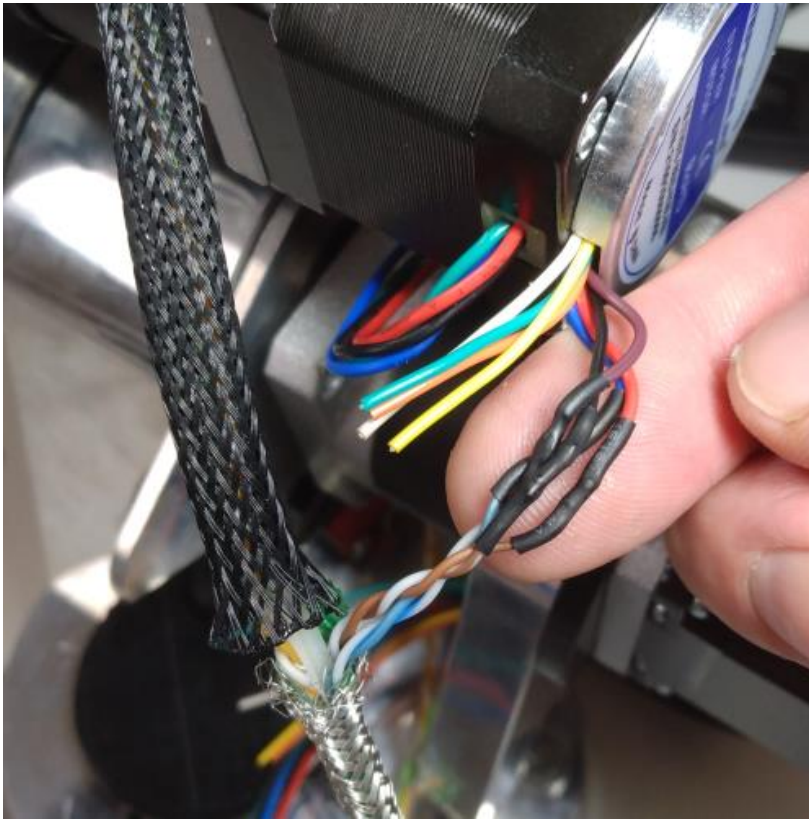

Solder and heat shrink the connection from the J3 encoder to the Cat6 cable as follows:

Encoder red wire to the cable brown wire.

Encoder black wire to the cable white – brown stripe wire.

Encoder brown wire to the cable white – blue stripe wire.

Encoder blue wire to the cable blue wire.

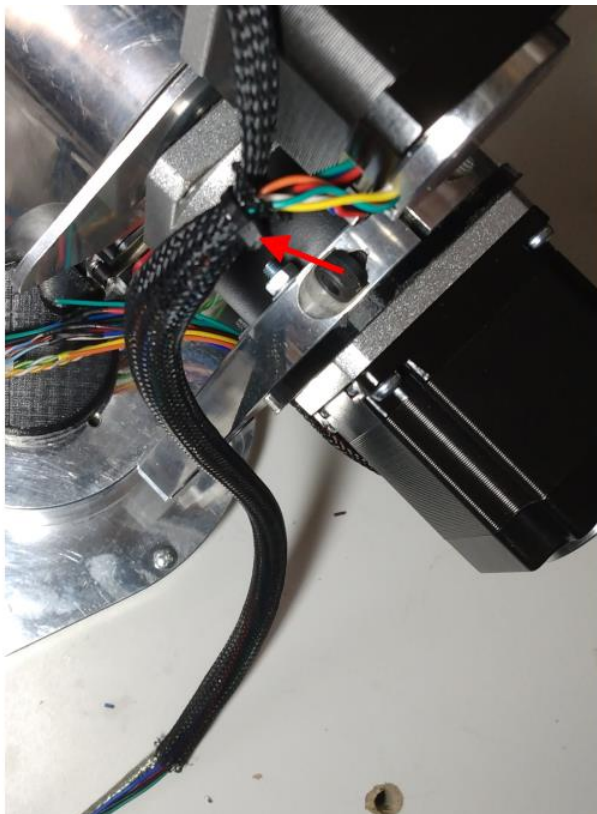

Cut length of 3/4" braided sleeve to a length of 35cm long then route J3 motor wires and J3 Cat6 cable through sleeve as shown.

Secure end of sleeve with cable tie (red arrow).



It is recommended to coat the exposed encoder and motor wires with liquid electrical tape.

Applying the liquid electrical tape can also be done later after fully testing the robot electrically.



Cut Red, Black, Blue & Green 20awg wires to a length of 50cm long.

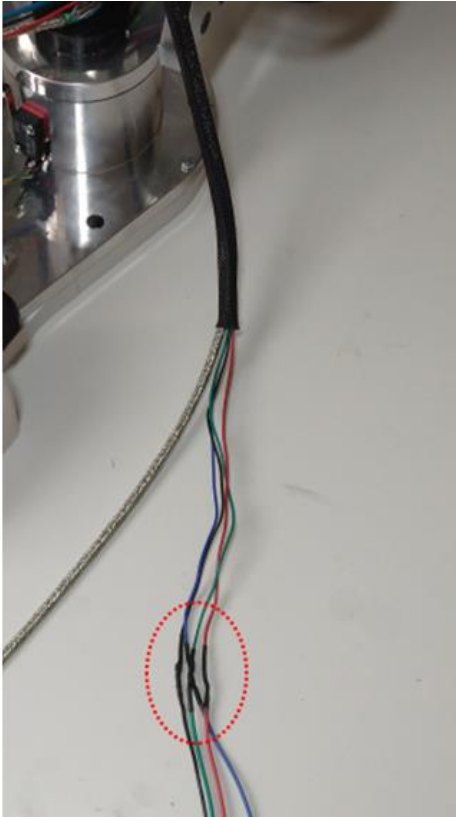

Solder and heat shrink 50cm long extension wires to the J3 motor wires as shown.

Be sure to match colors so that red goes to red and so on.

With the J3 motor wires extended the motor wires and Cat6 cable for J3 should now be the same length.

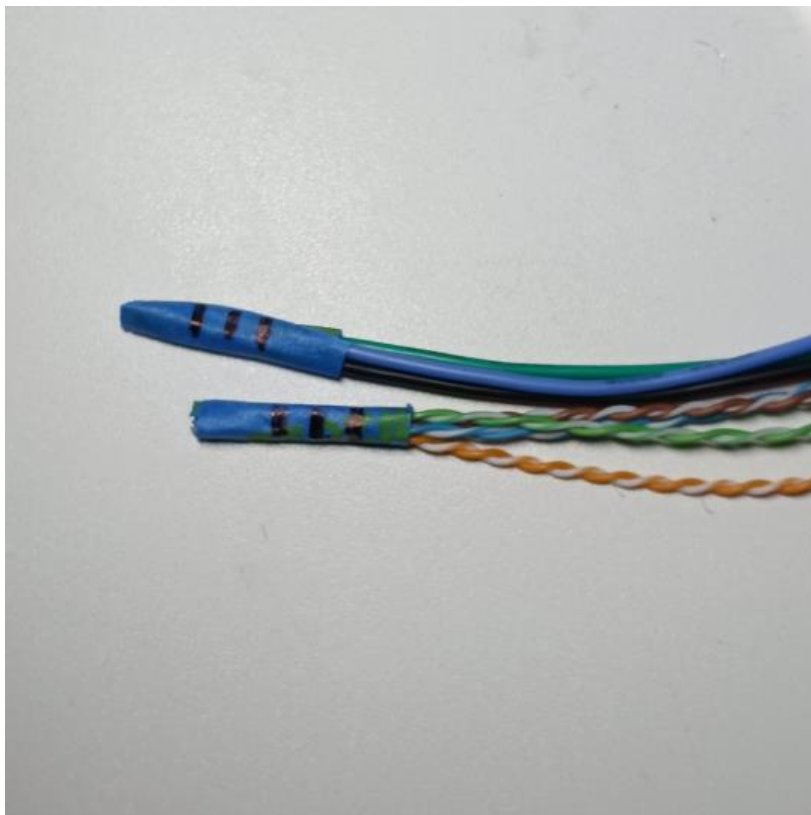

Wrap ends of J3 motor wires and J3 Cat6 cable with tape and then use a marker to put (3) stripes on each taped end so that you will know these are for J3 when wires have been routed inside enclosure.

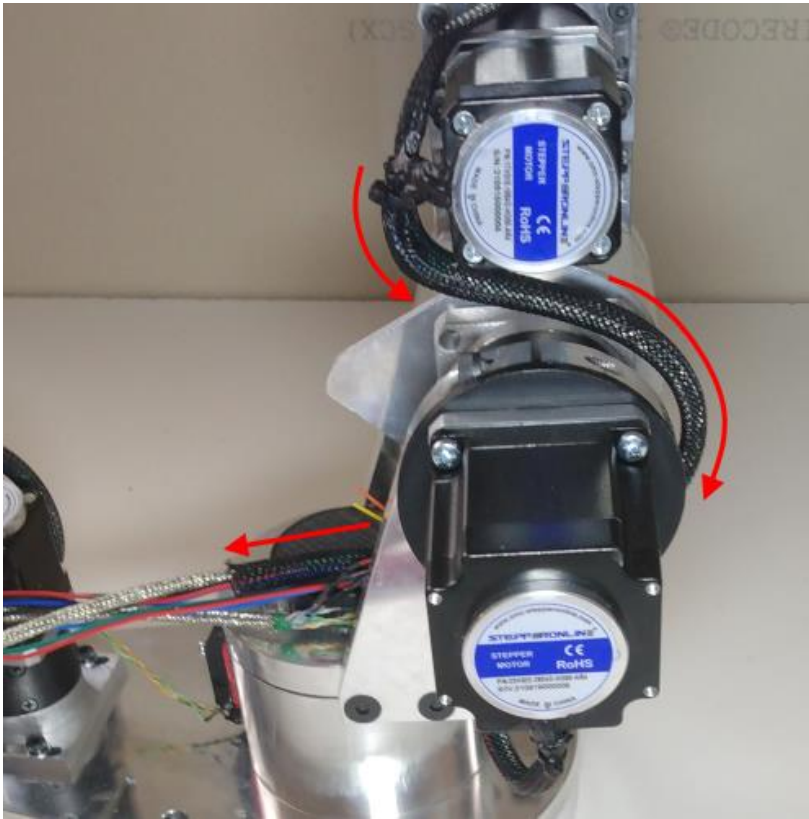

Route J3 motor and Cat6 wires over and then under the J2 gearbox and through center of robot as shown.

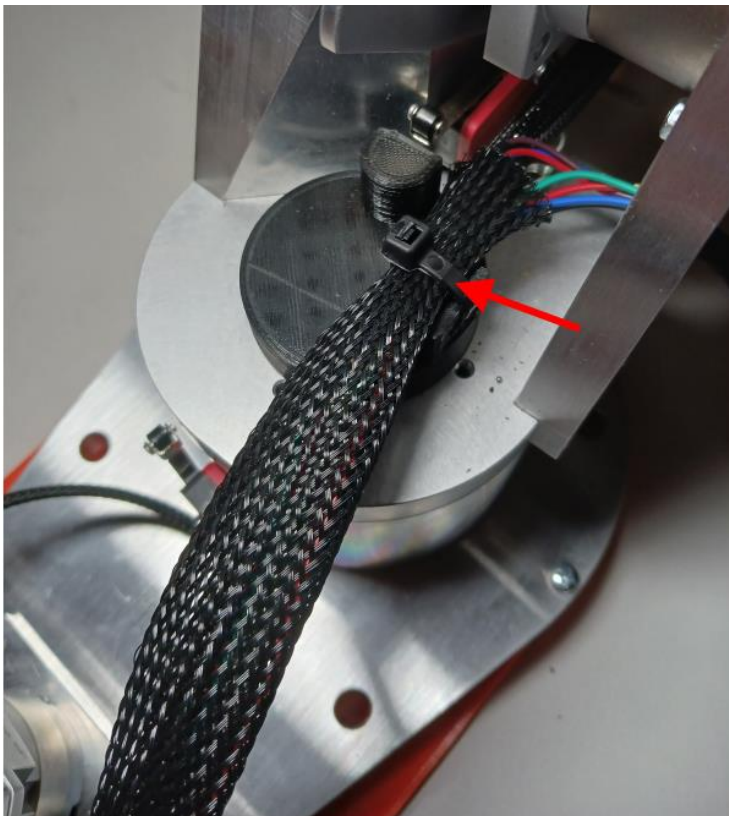

Cut length of 3/4" braided sleeve to a length of 52cm long then route all of the J2 and J3 wires and cables through sleeve.

Secure J2 / J3 wire loom to J1 stop with cable tie as shown (red arrow).

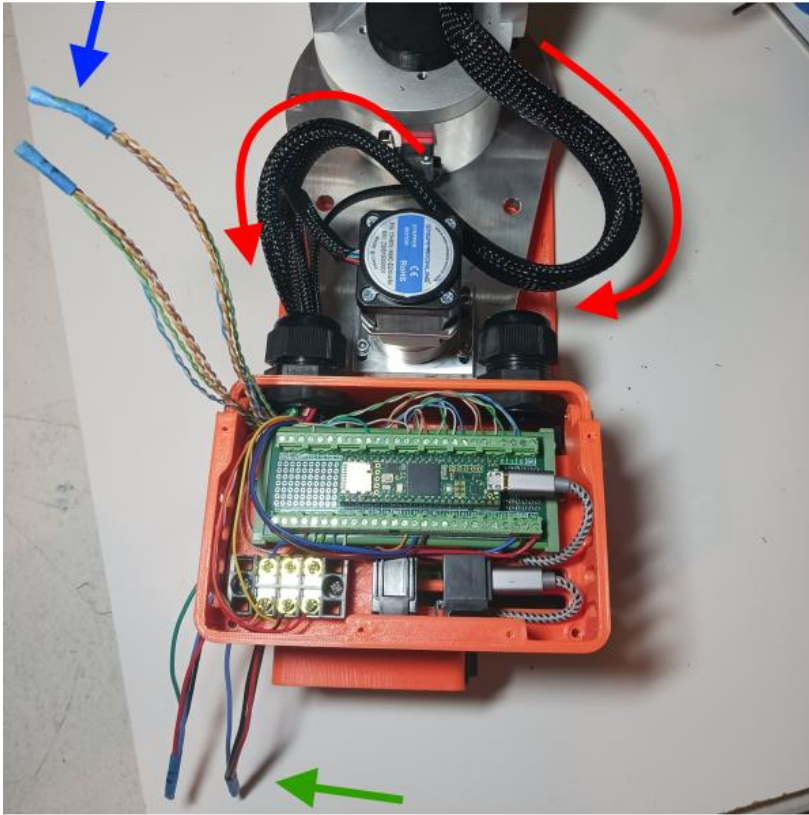

Route the J2 / J3 wire loom along with the J1 wires into the left enclosure gland nut as shown (red arrow).

When routing wires into enclosure, route the CAT5 encoder wires above the enclosure tray (blue arrow).

Route the motor wires below the enclosure tray (green arrow).

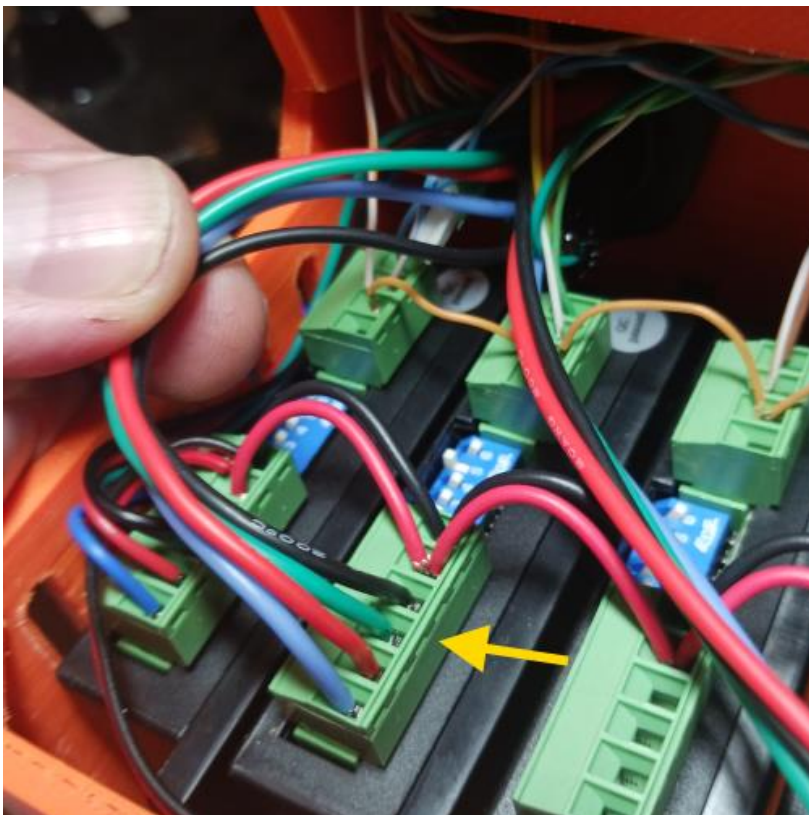

Find the motor wires that were taped with 2 marks for J2 then route and cut the wires as shown so that they are the appropriate length to reach the J2 driver terminals.

Connect the (4) J2 motor wires to the J2 driver terminals as follows:

A+ BLACK

A- GREEN

B+ RED

B- BLUE

NOTE: also see schematics chapter for wiring diagram

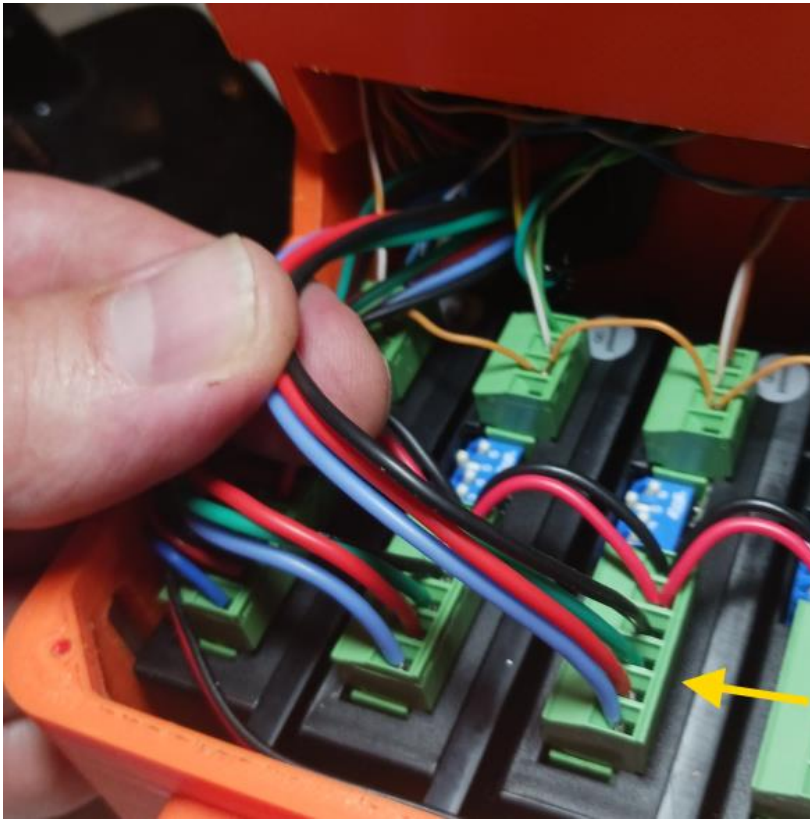

Find the motor wires that were taped with 2 marks for J3 then route and cut the wires as shown so that they are the appropriate length to reach the J3 driver terminals.

Connect the (4) J3 motor wires to the J3 driver terminals as follows:

A+ BLACK

A- GREEN

B+ RED

B- BLUE

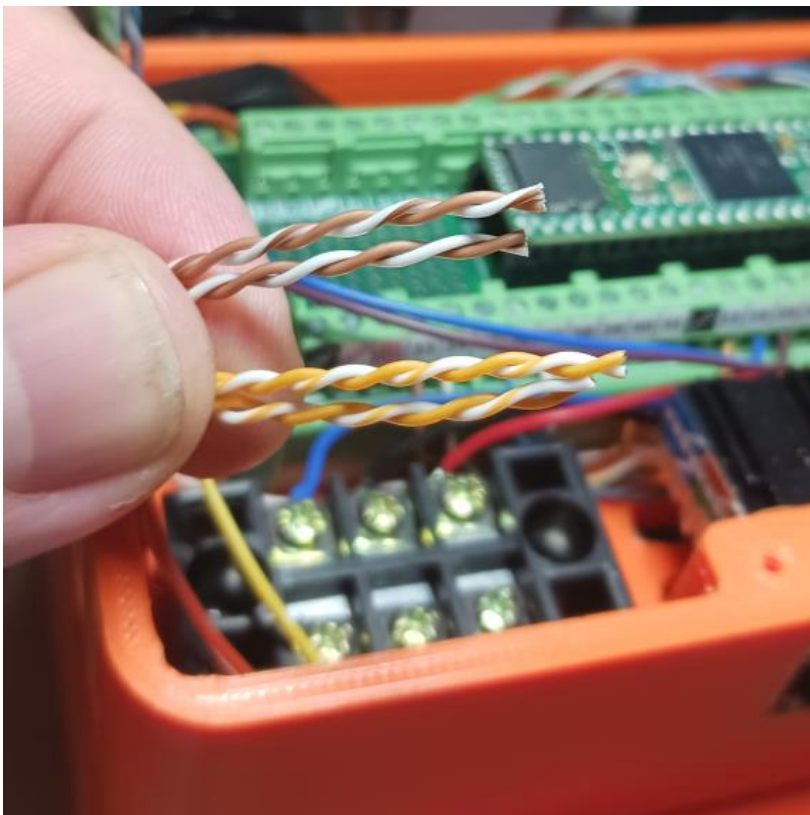

Find the brown and orange pairs of wires that were labeled for J2 and J3, separate these from the blue and green pairs but make sure the blue and green pairs remain labeled.

The brown wires supply 5v to the encoders and the orange wires supply 3.3v to the limit switches – its not important that these wires remain labeled.

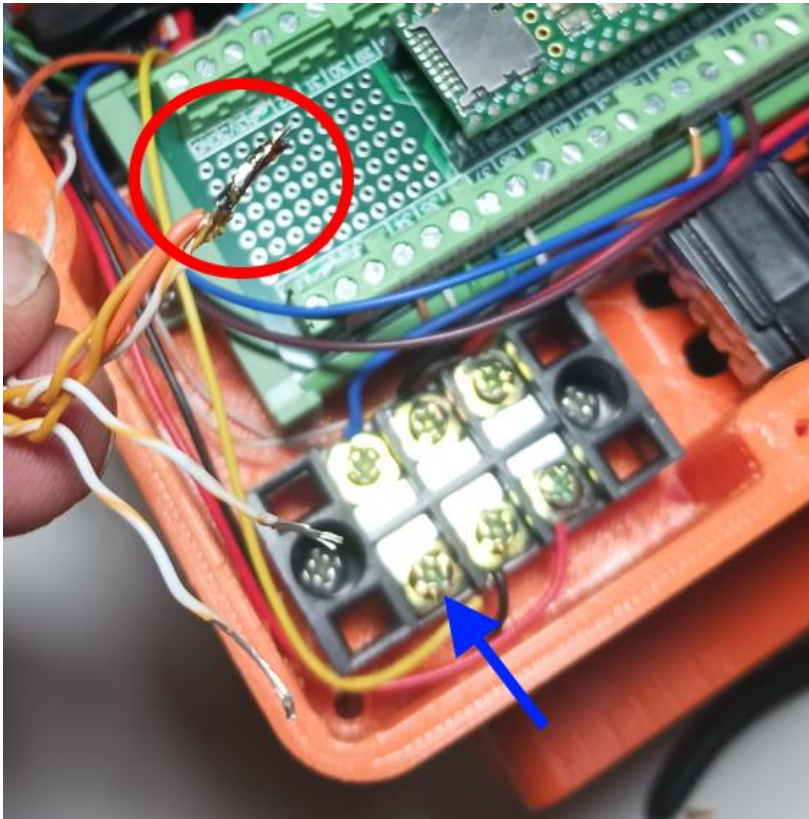

We need to connect both of the solid orange wires to the left 3.3v terminal on the 3 post terminal block (blue arrow).

This terminal already has the orange wire from the J1 limit switch and the orange stripe wire from the drivers OPTO terminal – it can be difficult to get all 4 of these wires under the terminal together and tightened down. I have found its easier to solder all 4 of these wires together (red circle). And then insert the group back into the terminal in a future step.

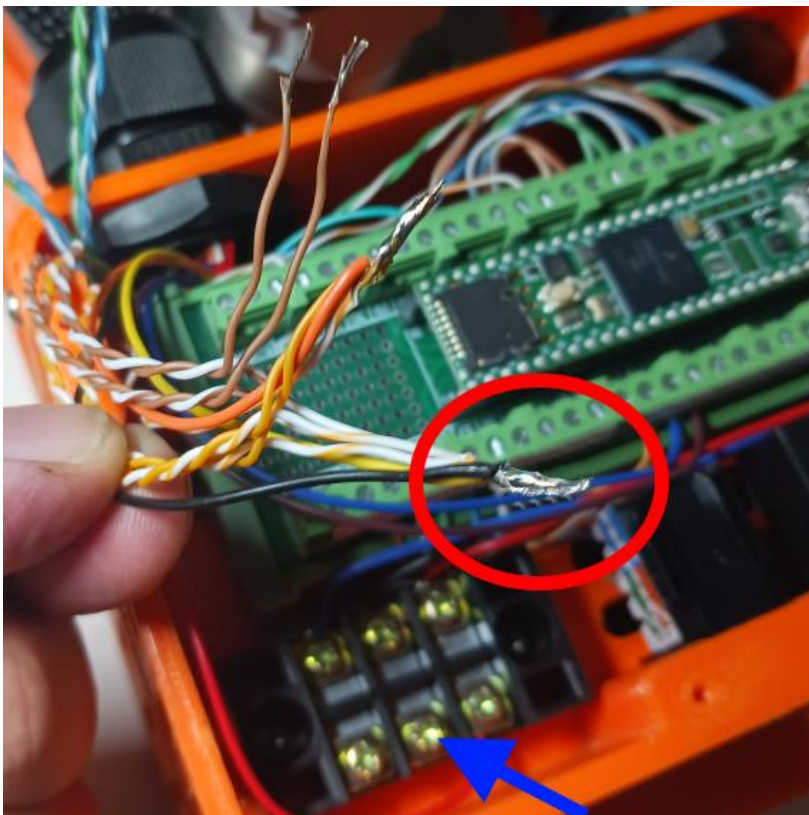

We need to connect both of the orange stripe wires and both of the brown stripe wires to the center GND terminal on the 3 post terminal block (blue arrow).

This terminal already has the black wire from the J1 encoder and the yellow wire from the J1 limit switch – it can be difficult to get all 6 of these wires under the terminal together and tightened down. I have found its easier to solder all 6 of these wires together (red circle). And then insert the group back into the terminal in a future step.

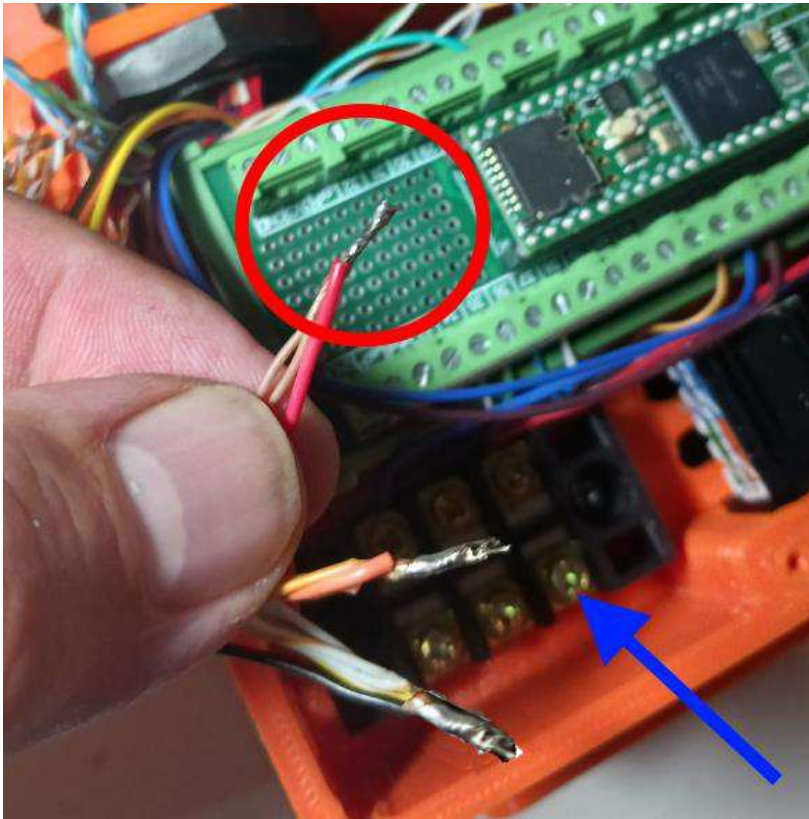

We need to connect both of the solid brown wires to the right 5v terminal on the 3 post terminal block (blue arrow).

This terminal already has the red wire from the J1 encoder– it can be difficult to get all 3 of these wires under the terminal together and tightened down. I have found its easier to solder all 3 of these wires together (red circle). And then insert the group back into the terminal in the next step.

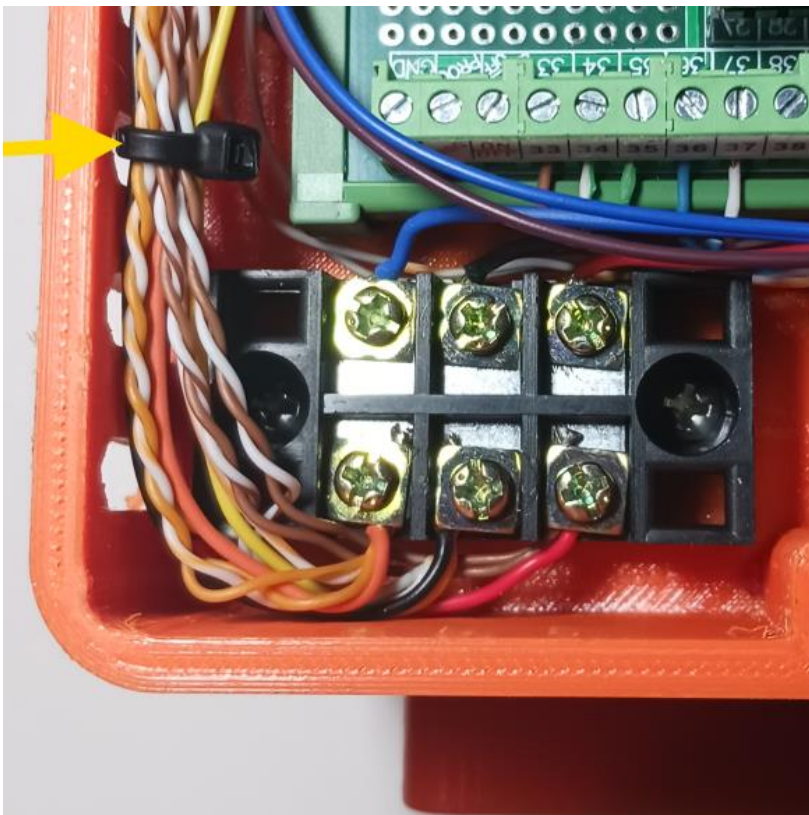

After soldering the groups of wires connect the orange 3.3v wires to the left terminal.

Connect the striped and black wire group to the center GND terminal.

Connect the brown and red wire group to the right 5v terminal.

Use a small wire tie to bundle all of these wires together (yellow arrow).

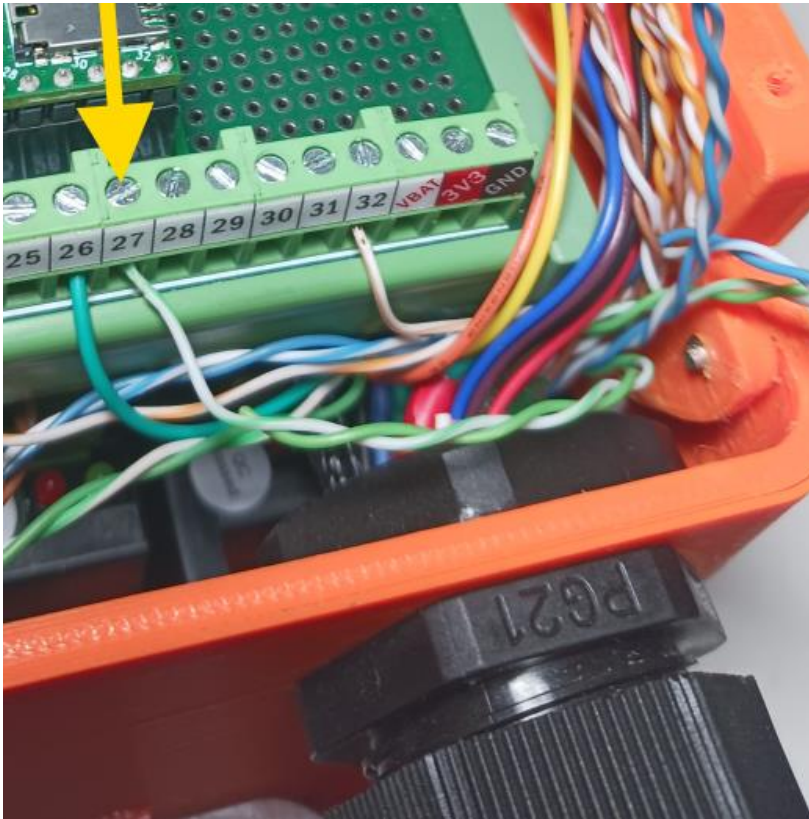

Find the green wires from the J2 group labeled with 2 stripes.

Route and cut the green wires to length to reach terminal 27 as shown.

Strip the end of the green stripe wire and connect to terminal 27.

NOTE: the solid green wire is not used and can be trimmed back and left unused.

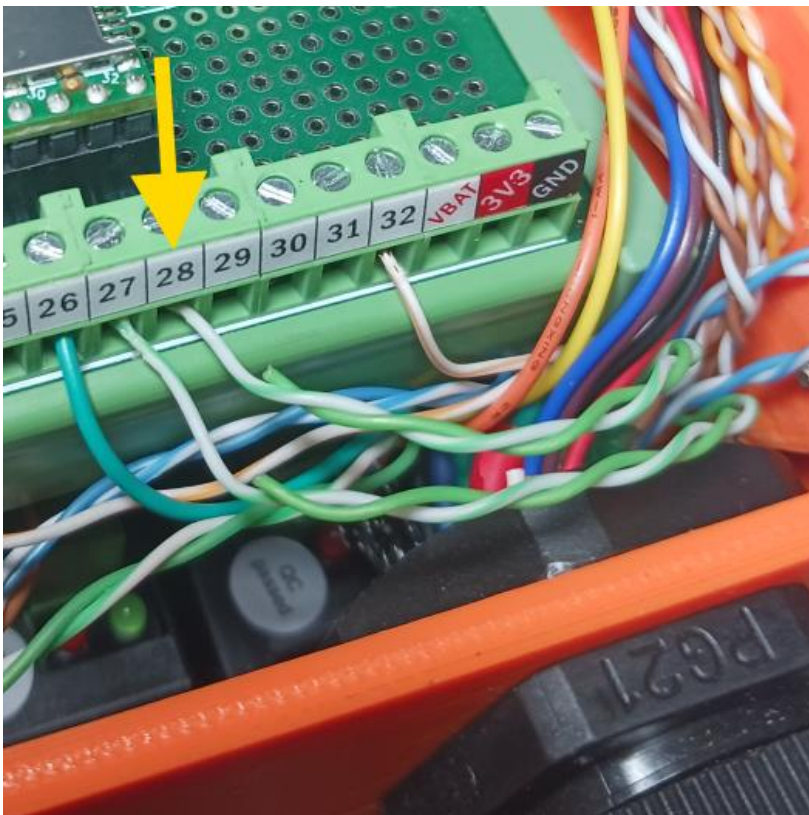

Find the green wires from the J3 group labeled with 3 stripes.

Route and cut the green wires to length to reach terminal 28 as shown.

Strip the end of the green stripe wire and connect to terminal 28.

NOTE: the solid green wire is not used and can be trimmed back and left unused.

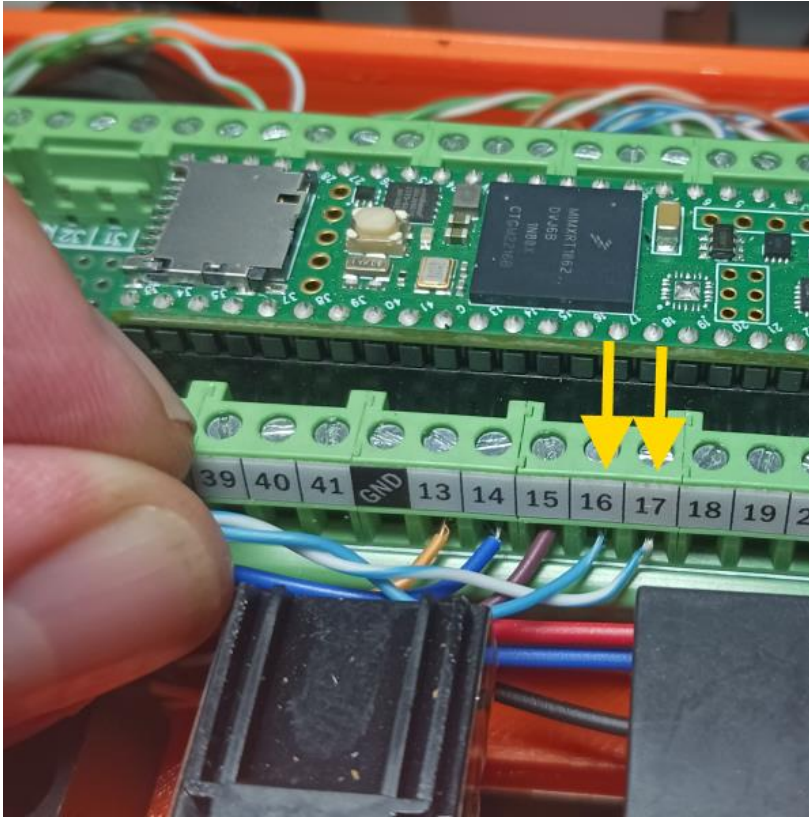

Find the blue wires from the J2 group labeled with 2 stripes.

Route and cut the blue wires to length to reach terminal 16 and 17 as shown.

Strip the end of the blue solid wire and connect to terminal 16.

Strip the end of the blue stripe wire and connect to terminal 17.

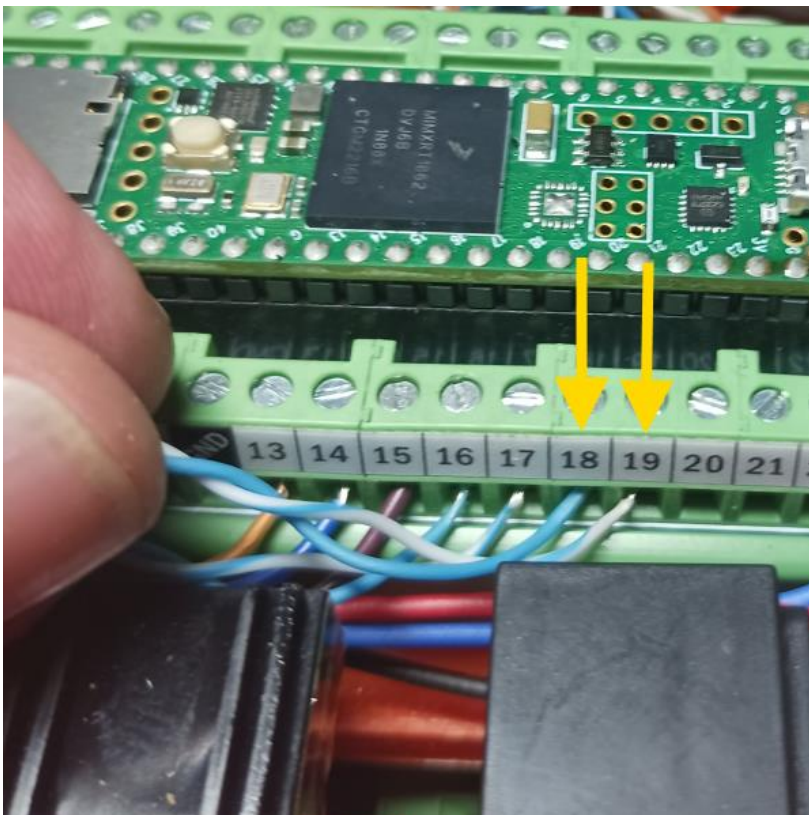

Find the blue wires from the J3 group labeled with 3 stripes.

Route and cut the blue wires to length to reach terminal 18 and 19 as shown.

Strip the end of the blue solid wire and connect to terminal 18.

Strip the end of the blue stripe wire and connect to terminal 19.

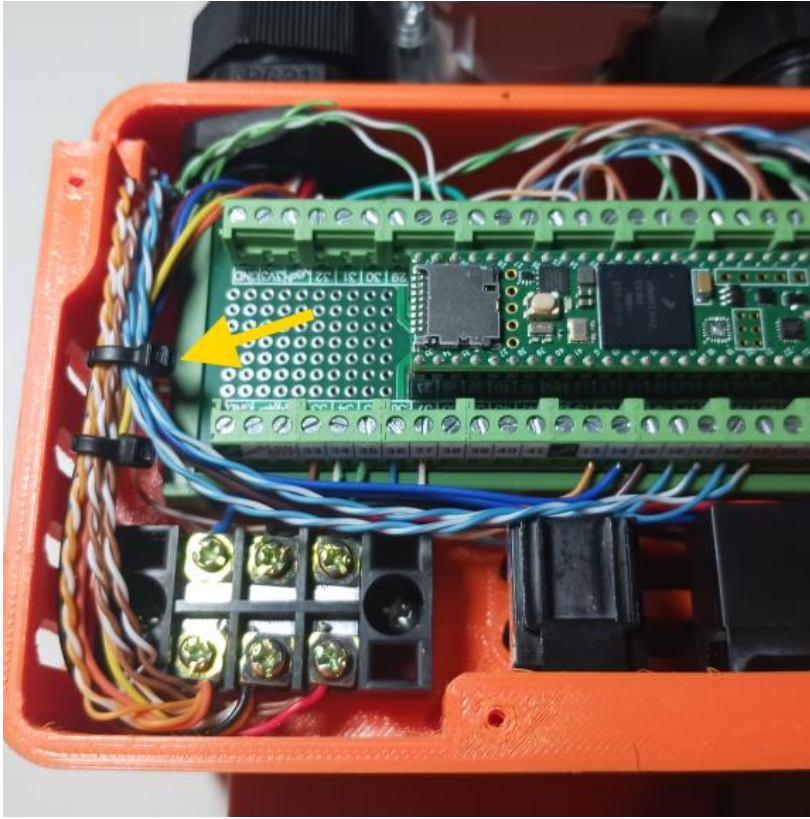

Use a small cable tie to bundle the J1, J2 and J3 encoder wires as well as the wires going to the terminal block as shown.



Secure AR4 logo into recess in J2 side cover using epoxy.



Install J2 side cover spacer and rest in place over the J3 belt and pulley as shown.

Please note: if you don't have a large bed printer this part is available to print in 2 pieces – see the folder [“Large Parts Split for Smaller 3D printer”](#)



Position the J2 side cover over the side spacer as shown, align the holes and install (1) M3x30 pan head screw.

Please note: if you don't have a large bed printer this part is available to print in 2 pieces – see the folder [“Large Parts Split for Smaller 3D printer”](#)



With the side cover and spacer held in place by the first screw now install the remaining (15) M3x30 pan head screws as shown.

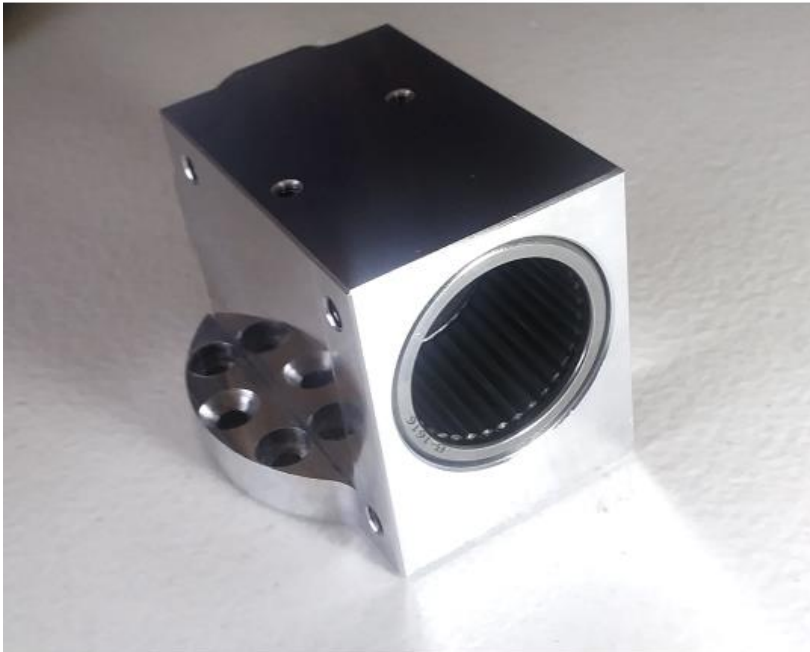

Press (2) B-1616 needle roller bearings into the J4 turret housing (install one on each side).

NOTE: don't forget to add a small amount of grease to needle bearings.

NOTE: This bearing can be a tight fit – please make sure to read the notes on bearing fit in overview section. I recommend heating the housing on a mug warmer prior to pressing needle roller bearings into housing. Please use a quality press and never hammer parts into place.



Secure J4 turret housing to J3 spindle using (2) M4x14 flat head screws (center) and (4) M4x10 cap screws (outer).



Use an M4 tap to thread each of the (4) holes around the perimeter of the J4 Timing Pulley.



Use an M4 tap to thread each of the (4) holes on the face of the J4 Timing Pulley as shown.

NOTE: It is important that the J4 timing pulley is no thicker than 15mm. If your 3D print is any thicker than 15mm use flat file or sandpaper on flat glass surface to carefully remove any excess material from the flat side shown.



Secure J4 timing hub to J4 main shaft and make sure one of the perimeter threaded holes aligns with the 2nd hole in J4 main shaft (yellow arrow)

Install (1) M4x10 set screw into the threaded hole that aligns with the 2nd hole in J4 main shaft (yellow arrow) – make sure set screw threads into J4 main shaft approx. 3 turns. This screw locks the alignment of the pulley and shaft.

Install and snug (3) M4x5 set screws in the remaining perimeter holes.



Install (1) TRD1625 (.126" thick) bearing washer over J4 main shaft and into J4 timing hub recess as shown.



Install (1) NTA1625 (1" ID) need roller bearing over J4 main shaft and into J4 timing hub recess as shown.

NOTE: don't forget to add a small amount of grease to needle bearings.



Install (1) TRA1625 (.032" thick) bearing washer over J4 main shaft and into J4 timing hub recess as shown.



Install J4 tube / timing hub assembly into the J4 turret as shown.

Make sure bearings are fully seated in timing hub recess and flush to J4 turret housing.



Install (1) M3x6 button head cap screw into J5 motor housing as shown. Do not fully seat the screw, leave one or two threads exposed. This screw will need to be adjusted in a future step.

This screw serves as a timing lug for the J4 limit switch.

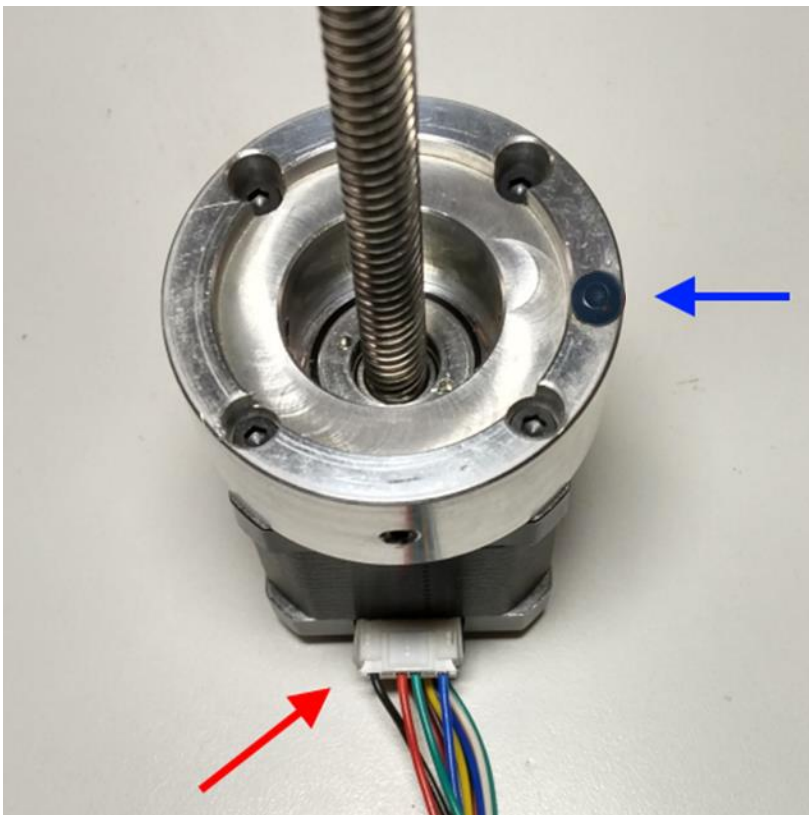

Secure J5 motor mount using (4) M3x16 socket head cap screws.

Note the motor connector is facing downward (red arrow) and the timing lug screw is 90° to the right (blue arrow).



Install (1) TRA1625 (.032" thick) bearing washer over J5 motor shaft and into J5 motor mount recess as shown.



Install (1) NTA1625 (1" ID) need roller bearing over J5 motor shaft and into J5 motor mount recess as shown.

NOTE: don't forget to add a small amount of grease to needle bearings.



Install (1) TRA1625 (.032" thick) bearing washer over J5 motor shaft and into J5 motor mount recess as shown.

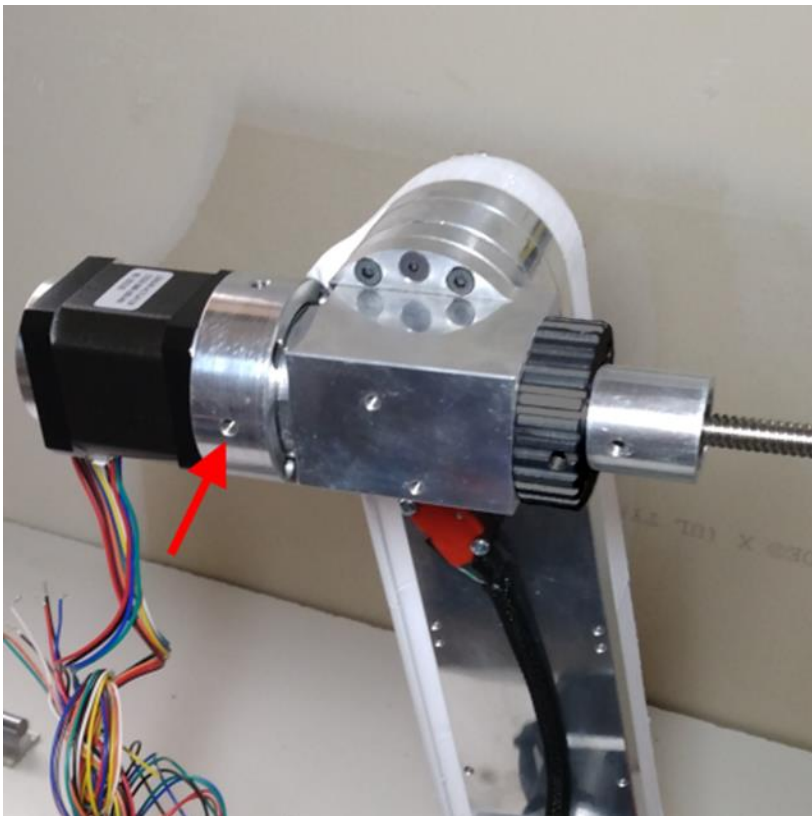

Install J5 motor assembly into J4 main tube as shown.

Be careful that bearings stay in place in J5 motor mount and slide over the end of the J4 main tube. When J5 motor mount is fully seated over J4 main tube and bearings are flush to J4 housing secure J5 motor mount to J4 tube using (4) M4x10 set screws. With motor connector facing down the set screw facing out (red arrow) should seat into hole in J4 main shaft.

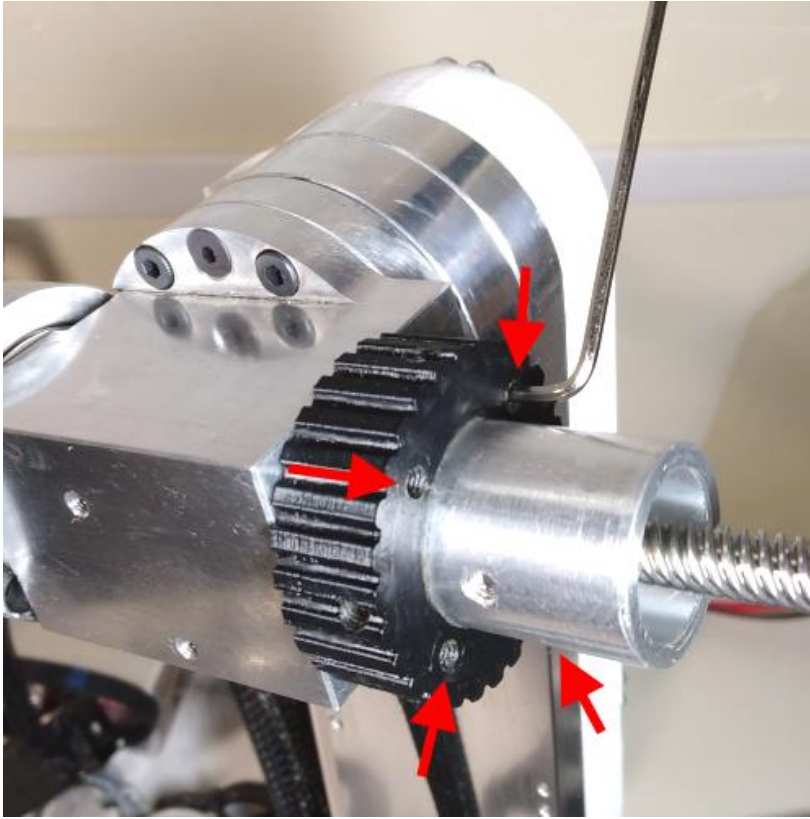

Install (4) M4x5 set screws into J4 timing hub in locations shown with red arrows.

Apply light tension to each screw, these screws will apply tension on all of the J4 bearings. Make sure screws are tensioned such that there is no play in bearing but not too much tension so that the motor and shaft still spin freely in housing.



Install J4 motor mount / limit switch contact block as shown and secure with (3) M4x10 socket head cap screws.

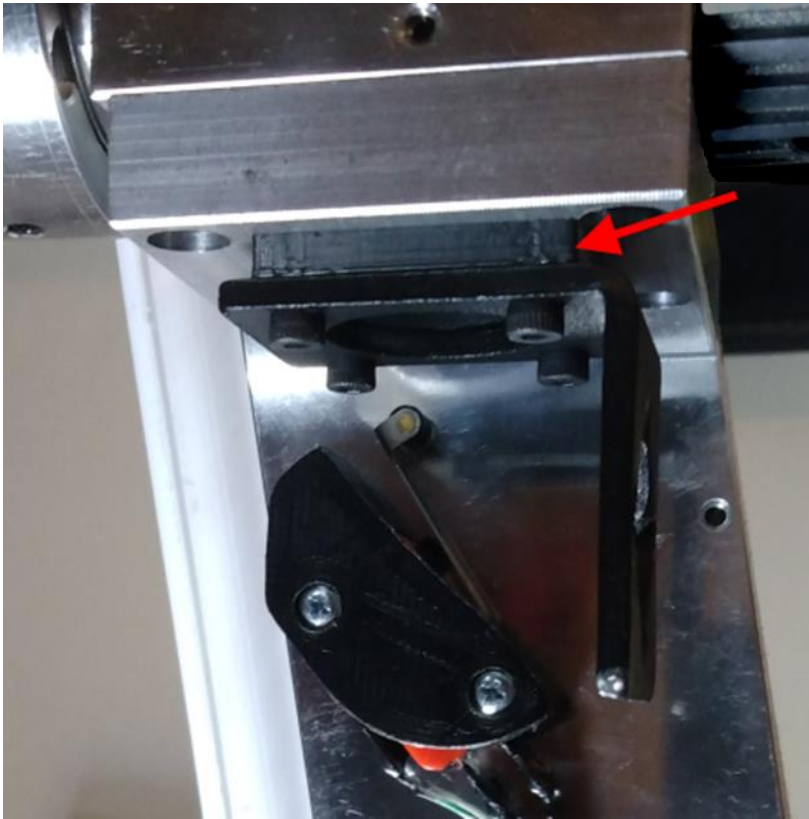

Install Nema 11 motor mount bracket as shown, place the 3D printed part “J4 motor spacer – 4mm” between the bracket and the aluminum (red arrow).

Secure with (4) M3x14 socket head cap screws.

The covers and spacers print files comes with 2mm, 3mm, 4mm and 5mm thicknesses of the “J4 motor spacer” so that you have some options to tension the belt given variation in the belt. If you are printing a 3D printed version I have found the 2mm spacer may fit best depending on your printer and filament material used.

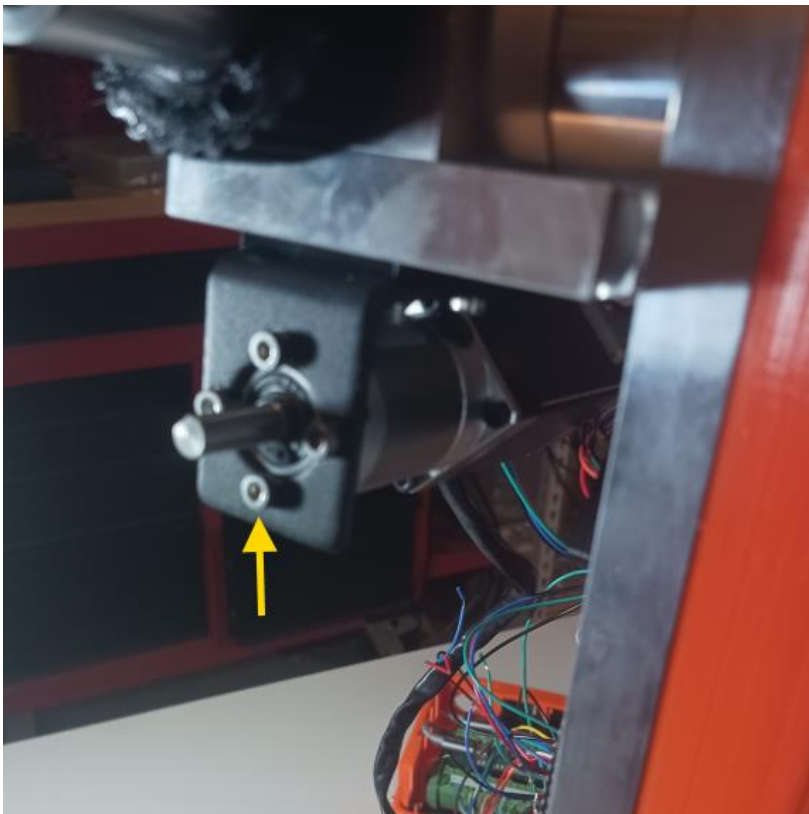

Install J4 motor and secure with (4) M3x5 socket head cap screws.

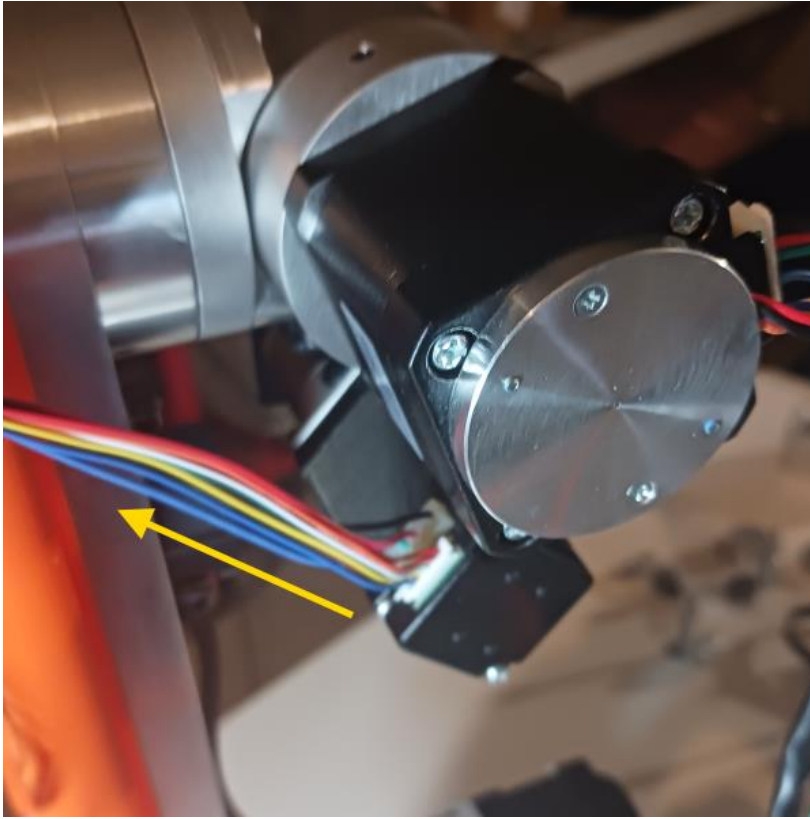

When installing the J4 motor make sure the motor and encoder wires are facing in toward the J2 arm as shown.

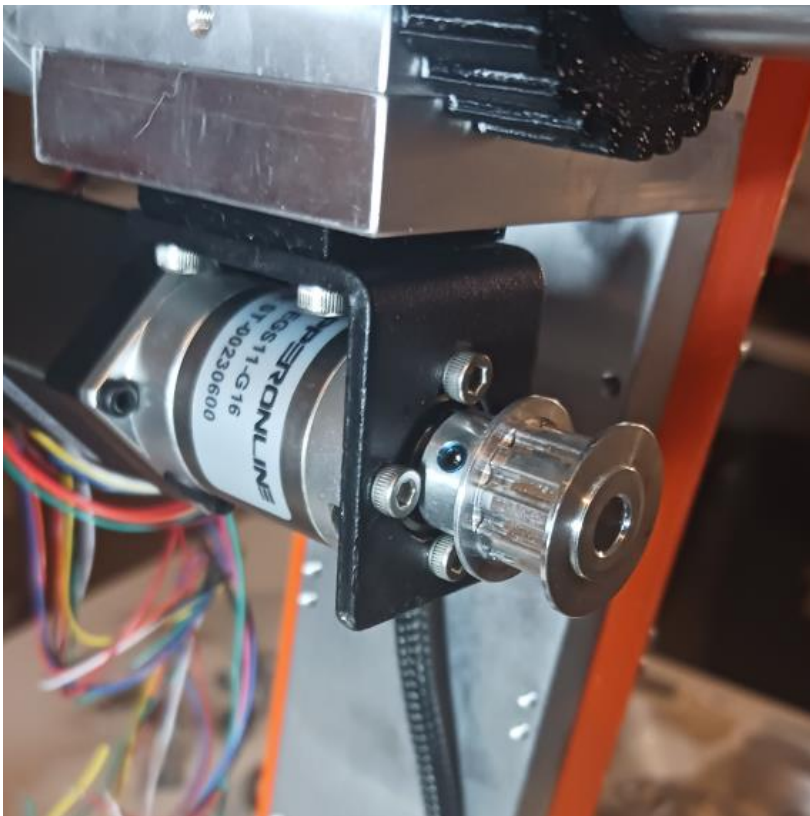

Install XL 10 tooth 6mm bore drive pulley onto J4 motor shaft and secure with (2) M3x4 set screws.

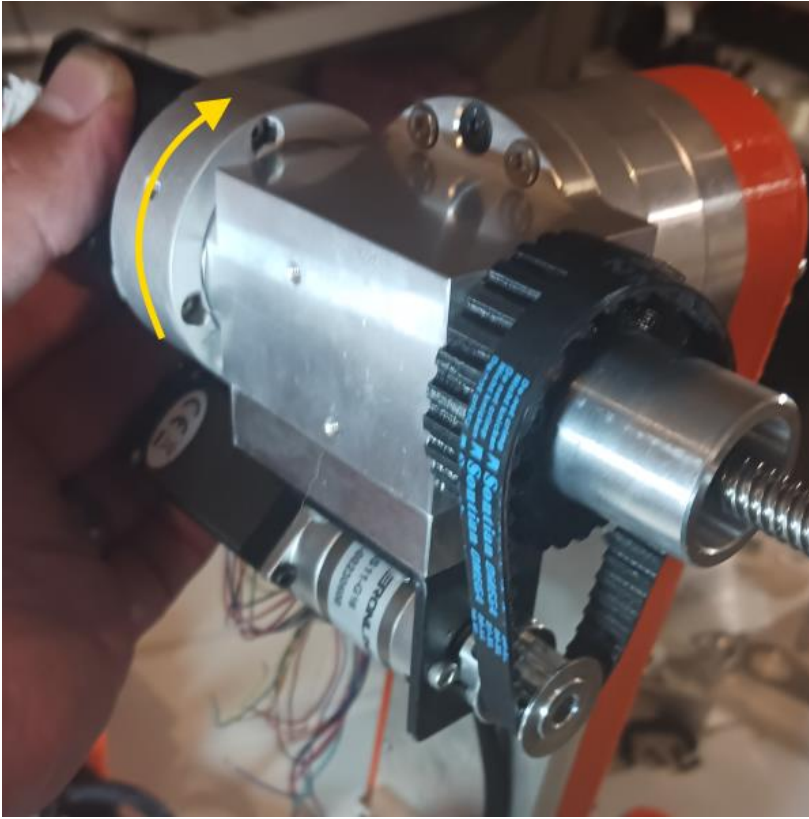

Install 84XL037 timing belt.
Place belt over the 10 tooth J4 motor pulley and then up over the main shaft sprocket – rotate the J5 / J4 assembly as belt rolls onto sprocket.



Countersink the (3) holes in POM nut that came with the J5 linear screw motor.



Install POM nut into the J5 carrier as shown and secure with (3) M3x10 flat head screws.

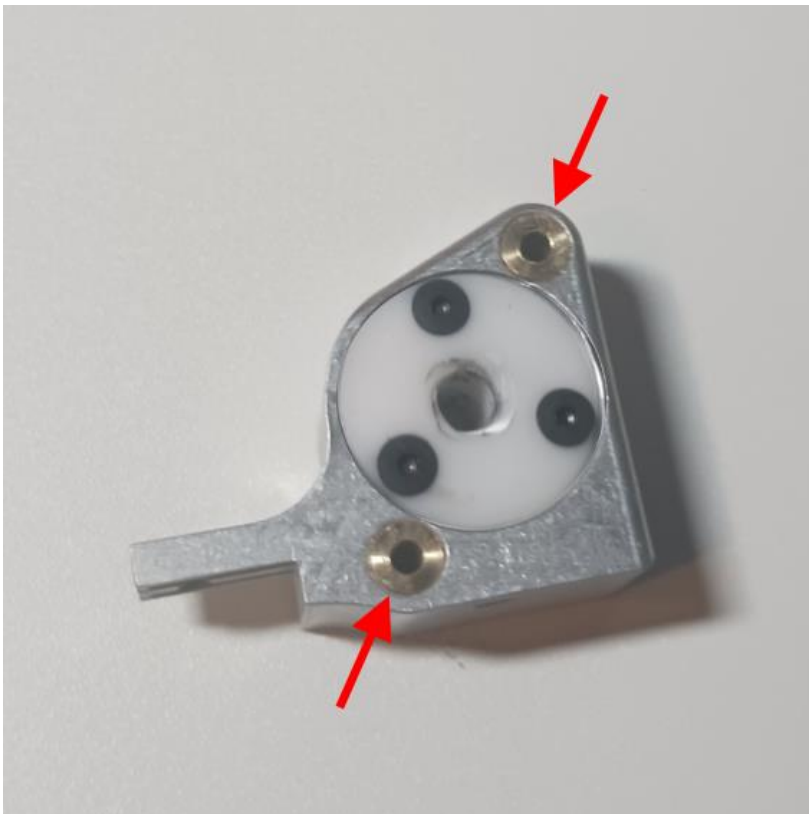

Press (2) 3mm ID x 20mm long brass bushings into the J5 carrier as shown.

NOTE: these can be a tight fit. If needed warm the carrier on a mug warmer prior to installation. Use a press or quality vice with protection over the jaws. Do not hammer these in place.

(See notes on bearing fit in overview section)

Secure bushings in carrier using (4) M3x4 set screws.

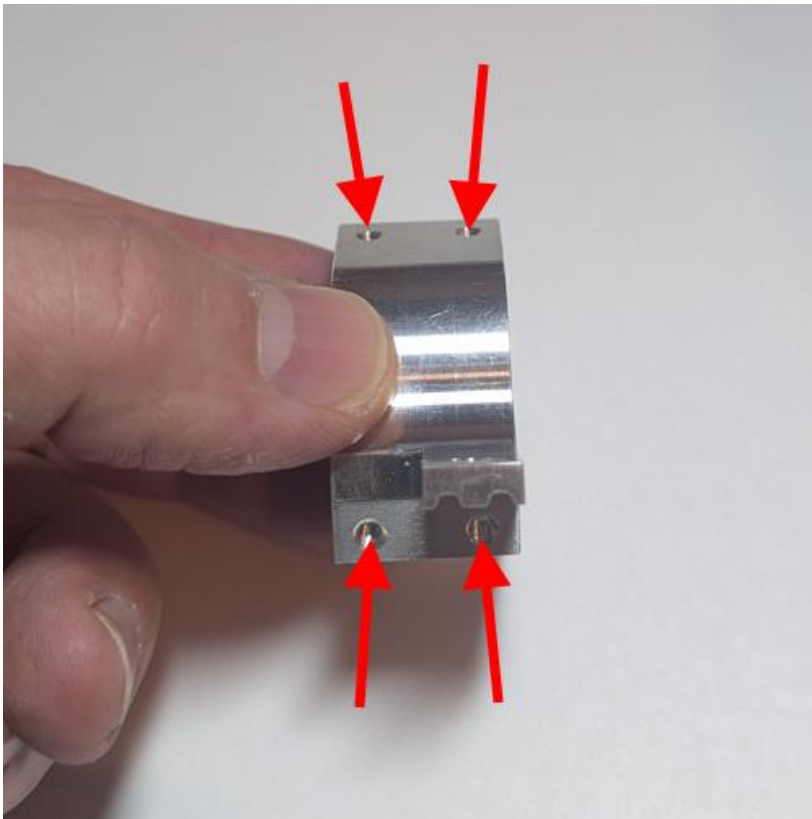

Make sure 3mm rods slide smoothly through each bushing after installation.



The rods are a tolerance fit but if you find the rods don't slide smoothly you can run in the bushings by placing the end of one of the rods into a drill, apply grease to the rod and then run it back and forth through the bushing while turning the drill at speed. After running it through the bushing for a short period of time the rods should slide smoothly through the bushing.

Place J5 carrier inside of the J5 housing, then install (2) 3mm linear rods through the J5 carrier bearings as shown.



Temporarily install M3x8 socket head cap screw fully threaded into hole as shown (red arrow) – this will prevent the 3mm rod from going too deep and blocking the hole.

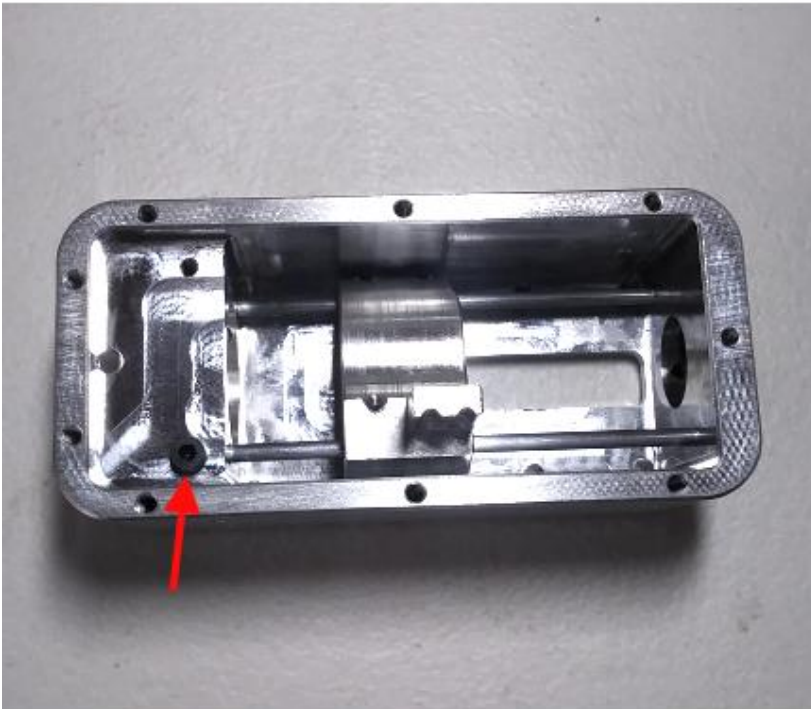

Finish sliding the 3mm rods into place as shown.



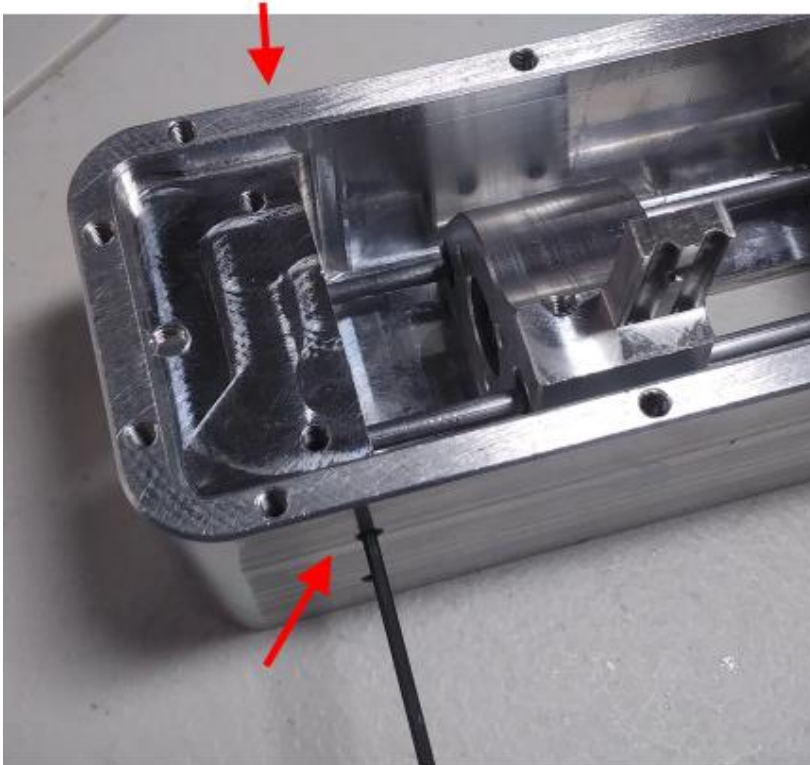

Secure both 3mm rods in place using (2) M3x6 set screws – one from the top and one from the bottom (red arrows).

Then remove the M4 cap screw that was placed temporarily to prevent the rod from inserting too far.

Make sure to verify that the carrier slides easily on the rods.



Make sure the J5 carrier slides smoothly in both directions. If you find there is any binding apply grease to the rods and move the carrier back and forth by hand until the bushings are broken in and the carrier slides easily. If you have trouble or find there is any binding you may need to remove the rods and repeat the earlier step using a drill to run in the bushings.



Install the J5 idler tension block and secure with (2) M4x8 socket head cap screws.





Install HK1612 bearing over the J5 bearing post as shown.



Install 3D printed bearing post spacer over the J5 bearing post as shown.



Secure the bearing post and bearing to the J5 tension block using (1) M4x14 socket head cap screw as shown.



Prior to installing the 688Z bearing into the J5 housing verify the end of the J5 linear drive motor lead screw fits cleanly into the 688Z bearing. There have been some cases where the flute edges at the end of the lead screw are flared. If the end of the lead screw has any interference inserting into the bearing use a file to carefully knock down any high spots and verify the lead screw end inserts easily into the bearing.





Install 688Z bearing in end of J5 housing as shown and then secure with M3x6 set screw.

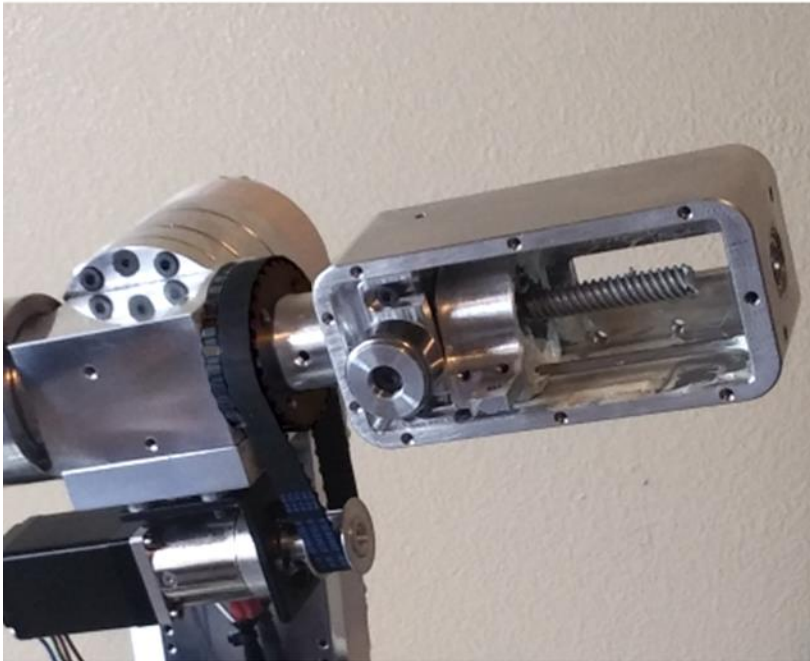

Spin J5 housing assembly onto J5 motor lead screw as shown.





Before proceeding to the next step of inserting the J5 housing onto the J4 shaft:

These are typically a slip fit – make sure all surfaces are clean and free of burrs or debris. **Do not force or twist into place – if it does not slide on by hand then polish J4 main shaft before inserting.**

If the fit is slightly loose - apply a small amount of retaining compound around the entire perimeter of the end of the J4 shaft to ensure any play between the shaft and housing are alleviated once the compound has set.

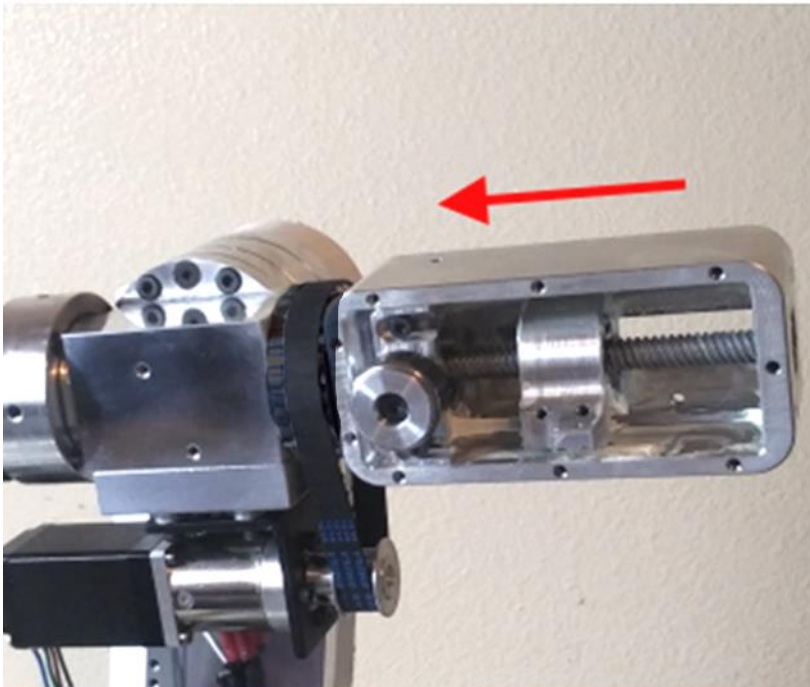

Slide J5 housing assembly forward onto J4 main tube until fully seated against J4 timing hub.

Note on robot weight: from this point forward as we add more components to the upper robot arm the J3 motor will at some point start to sag or drift downward and not support the weight of the arm. This is normal, once the robot motors are powered the robot will be rigid and support its own weight, for now with no power you may need to put something under the arm to support it or rotate the arm to the vertical rest position for some of the future assembly steps.

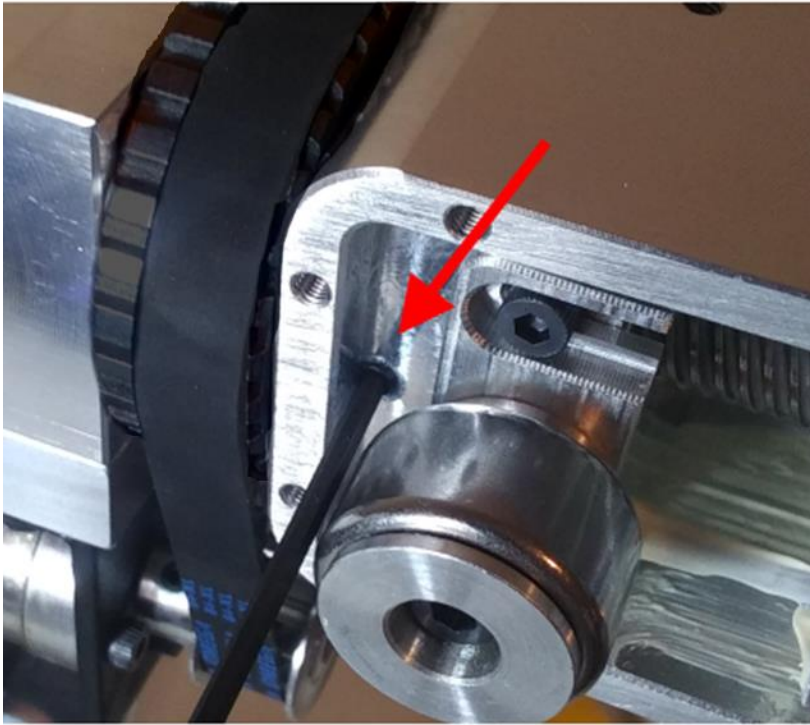

Install M4x10 set screw (red arrow) to secure J5 housing to J4 main tube, make sure screw fully threads into hole in J4 main shaft to ensure clocking is correct and housing is secured to main shaft.

Allow retaining compound to set for 1 to 2 hours before proceeding with any further work on the J5 housing or disturbing the J5 housing in any way.



Press #30203 taper roller bearing race into J6 main bearing support arm.

(See notes on bearing fit in overview section)



Secure J6 main bearing arm to J5 housing using (6) M4x18 flat head screws.



Press #30203 taper roller bearing onto J6 housing side post.

NOTE: don't forget to add a small amount of grease to taper bearings.

(See notes on bearing fit in overview section)



Install (1) TRD1625
(.126" thick) bearing
washer into J6 bearing cap
recess as shown.



Install (1) NTA1625 (1" ID)
needle roller bearing into J6
bearing cap recess as
shown.

NOTE: don't forget to add a
small amount of grease to
needle bearings.





Install (1) TRA1625 (.032" thick) bearing washer into J6 bearing cap recess as shown.

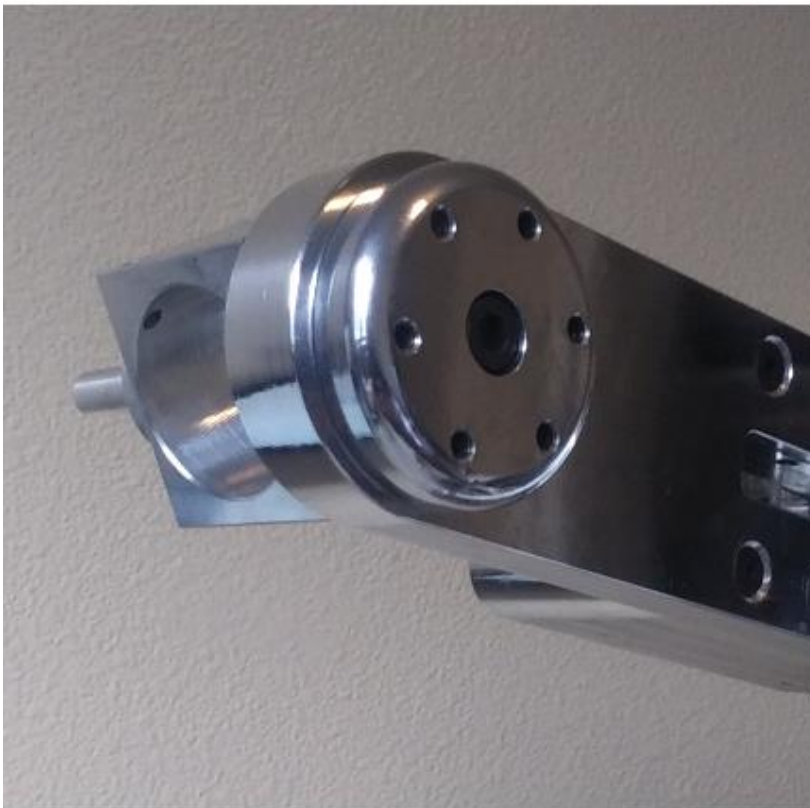

Install J6 housing from left side as shown and then install the J6 bearing cap (with bearings) from the right. Secure bearing Cap to J6 housing using (1) M6x14 socket head cap screw.



Install (6) M4x5 set screws in perimeter of bearing cap.

These set screws will apply tension on J6 bearings.

Set tension evenly on all set screws so there is no play J6 housing rotation but also that it rotates smoothly.

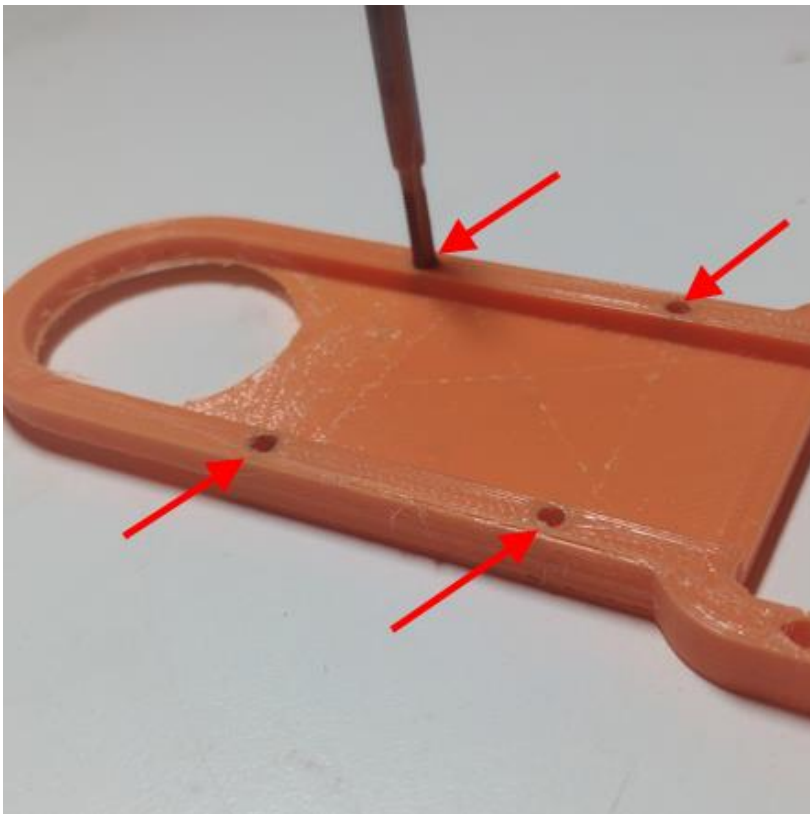

Use M3 tap to thread the front (4) holes in J5 side plate (red arrows).

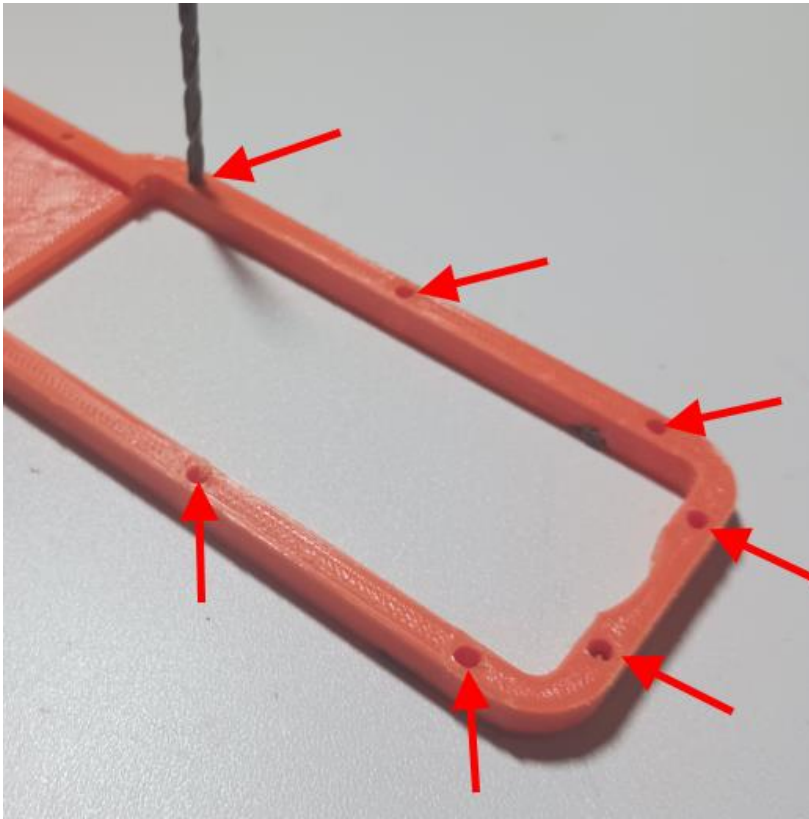

Use #30 (.128" or 3.25mm) drill bit to clear the rear (8) holes on J5 side cover spacer.



Secure 10T85 limit switch to J5 side cover using (2) M2.5x8 pan head screws as shown.

Make sure the red button is oriented as shown so that the button is down and printed text on switch is facing out.



Install J5 side plate as shown, temporarily install (1) M3x25 philips head pan screws to hold side cover in place.

NOTE: this is an older photo and the 10T85 limit switch is not shown.



Install XL15 pulley onto J6 housing post as shown.

If the pulley does not slide onto the J6 housing shaft easily do not force it. Pulley manufactures and tolerances vary – polish the shaft or pulley bore to achieve a slip fit if necessary.

Do not tighten set screws at this time.



Cut a length of continuous flex Cat6 cable to a length of 124cm long and remove outer jacket. (see overview section on jacket removal)

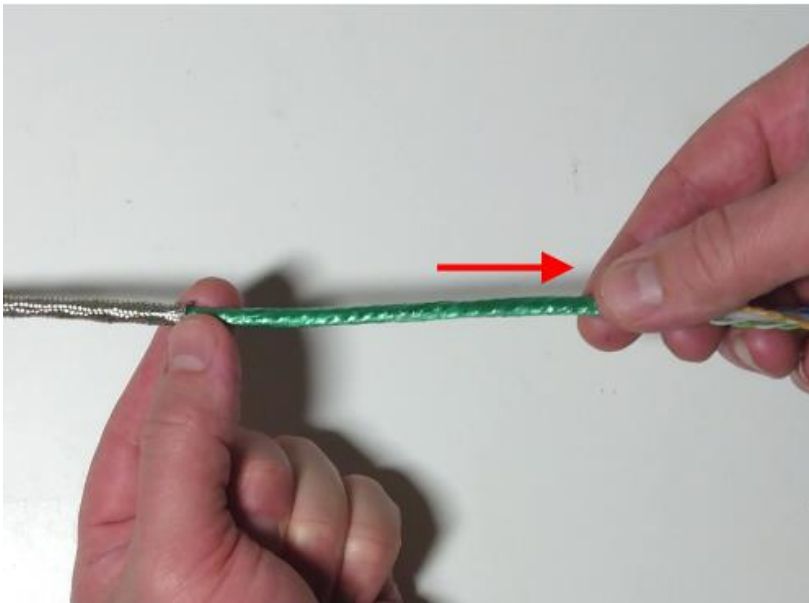

Joint 5 is a little different from the other joints due to the fact that the J5 limit switch is not located close to the J5 motor and the limit switch is on the other side of joint 3. Because of this we will need to run the J5 limit switch wires separately from the J5 encoder wires. To make this happen we will need to separate the J5 limit switch wires from the J5 encoder wires. To separate the wires first grasp the shielding in one hand and pull on all the wires with other – you want to remove all the wires completely from the shielding.



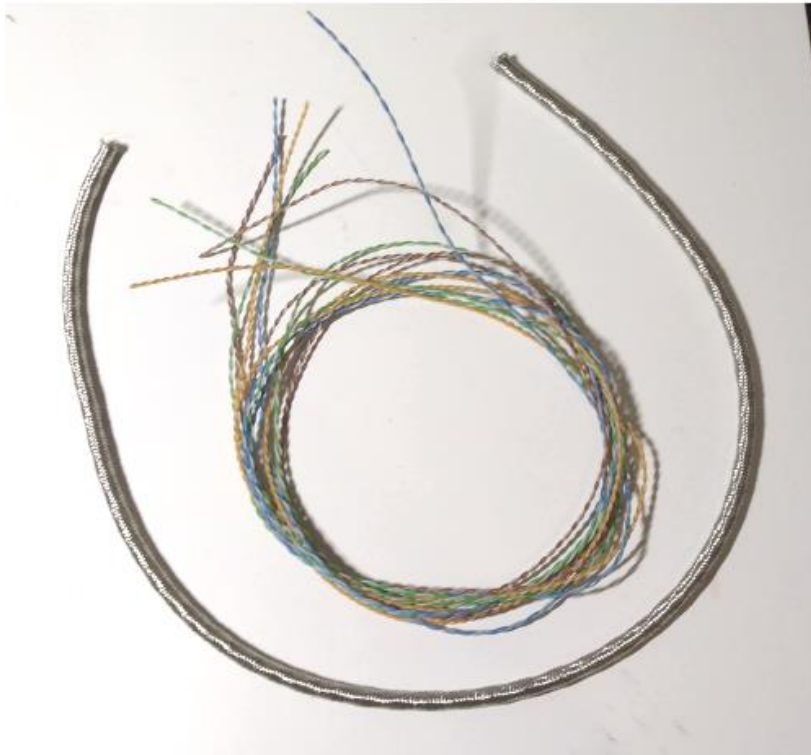

Pull all the wires out of the shielding and remove the green wrap and center core leaving just the shielding and the 4 twisted pairs.



In the next step we will use the orange and green pairs for the J5 limit switch.

Save the blue and brown pairs and the shielding for a future step.

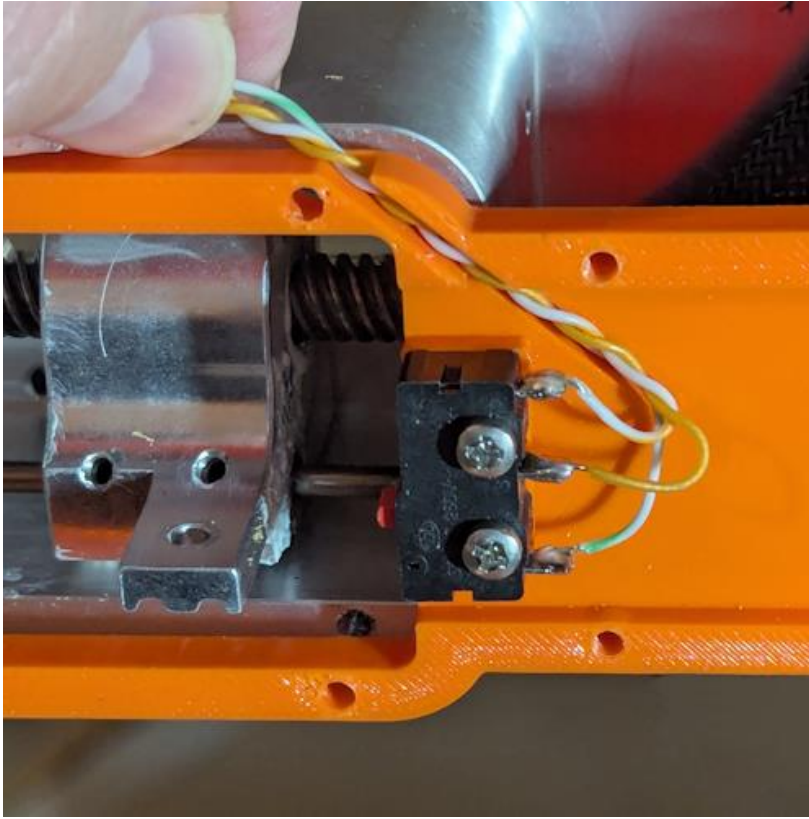

Solder orange wire to “NO” terminal of 10T85 limit switch.

Solder white with orange stripe wire to the “NC” terminal.

Solder the white with green stripe wire to the “C” terminal.

Note: the green wire is not used and should be trimmed back.

(also see wiring diagrams in chapter 4)

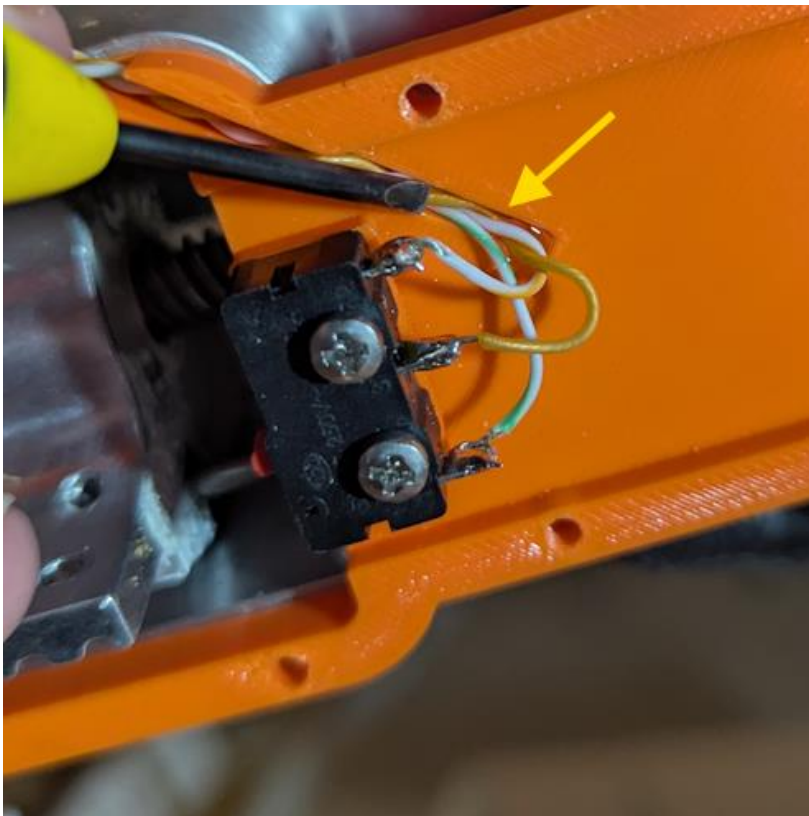

Use a small screwdriver to press the 3 wires down into the slot. Apply a small drop of super glue to ensure the wires stay seated down in slot (yellow arrow).



Use #30 (.128" or 3.25mm) drill bit to drill a hole in 150XL belt as shown.

Hole should be directly between 2 of the ribs.

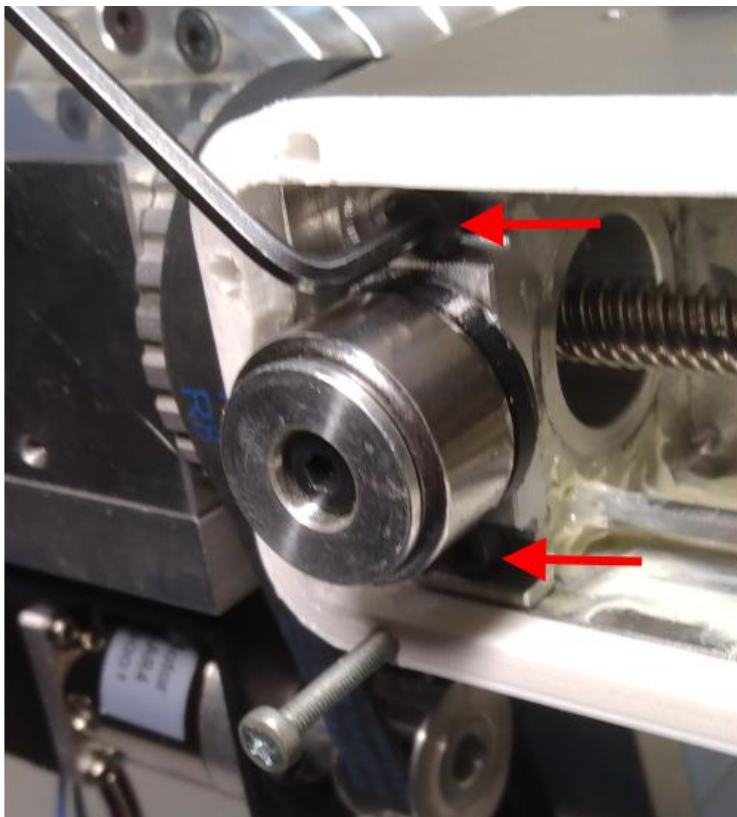

Adjust J5 idler tension block so that when you try to install the belt it is just barely too tight or is very difficult to slip over the idler bearing.



150XL belt should be just barely too tight so that it is very difficult to slip it over the idler bearing.

Note: when using 3D printed components you may not be able to get the belt this tight.

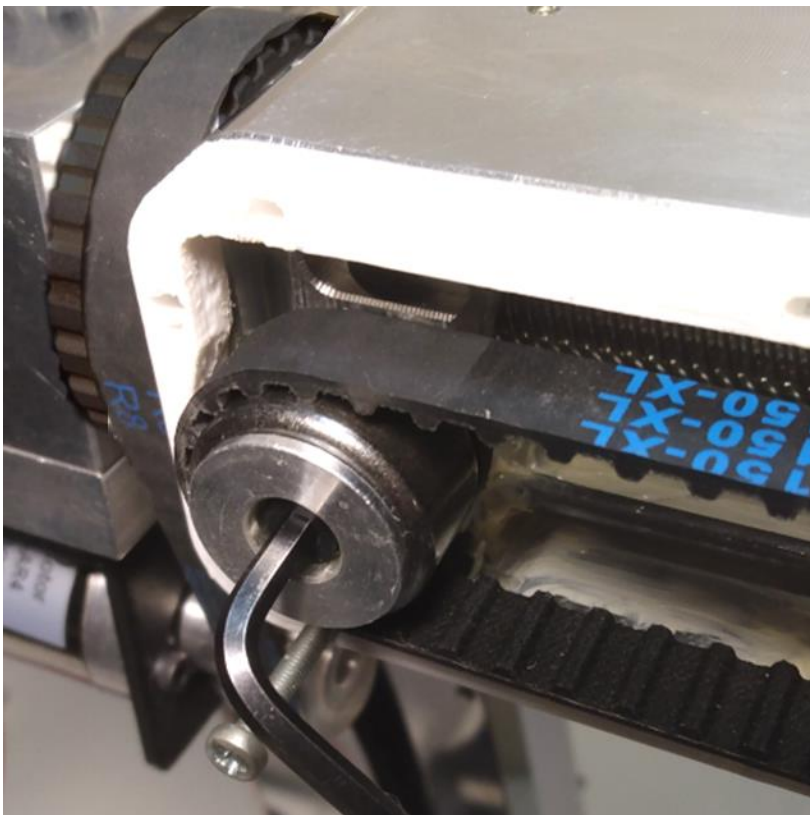

When installing the 150XL belt loosen bearing post mounting screw so that post tips back slightly making it easier to slide belt onto idler bearing.

Next tighten post mounting screw – this will result in a very tight belt adjustment.



Place M3x8 cap screw into 3D printed J5 Carrier Bump Stop as shown.

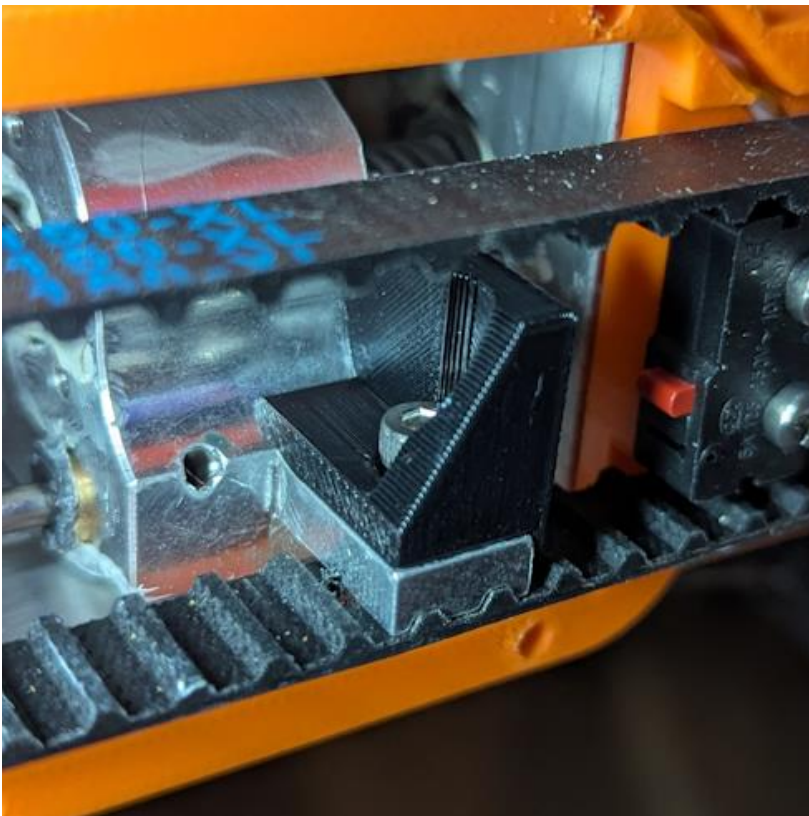

Install the J5 Carrier Bump Stop and cap screw onto the J5 carrier as shown.

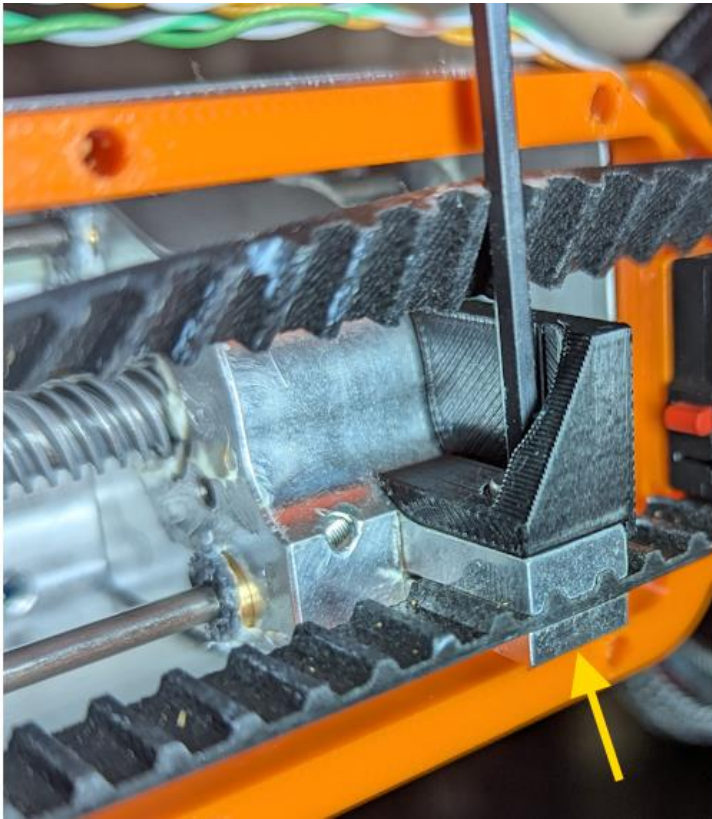

Make sure the hole drilled in belt is aligned with the J5 carrier and install (1) M3x8 cap screw through belt and threaded into J5 carrier clamp as shown (yellow arrow).

Make sure screw is tight and belt is secured to J5 carrier.

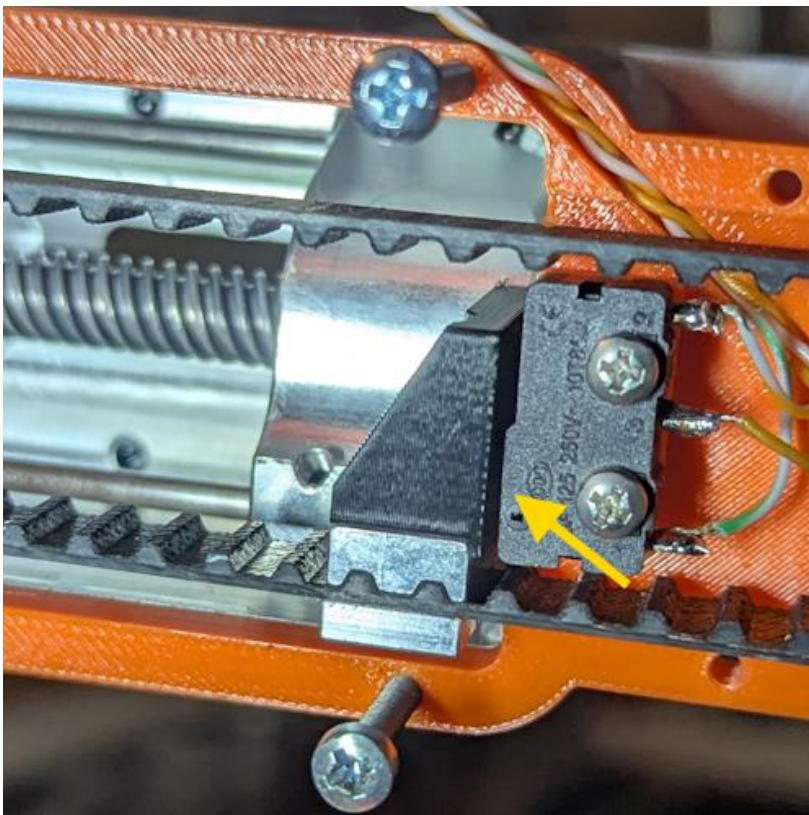

Temporarily install 2 more M3x25 philips head pan screws to hold side cover in place – then manually rotate the J5 motor drive screw until the carrier moves forward the depresses or trips the J5 limit switch (yellow arrow).

The drive screw can be difficult to reach in and turn with your fingers – you may need to put some electrical tape on the tips of some needle nose pliers to turn the drive screw using the pliers.

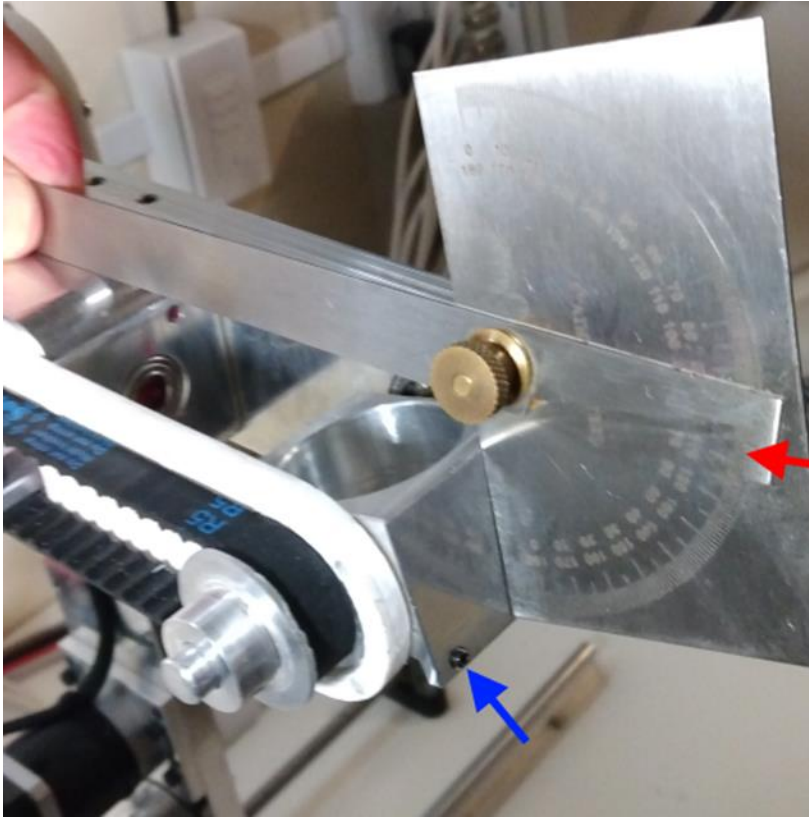

Make sure set screws in J6 XL15 pulley are still loose.

Make sure the J5 carrier is in the forward position and that the limit switch has just clicked.

Rotate J6 housing to an up angle so that the motor side is down. *(note blue arrow – motor mount screw hole is down)*

Use angle gauge and set J6 housing angle to **105°** (red arrow).

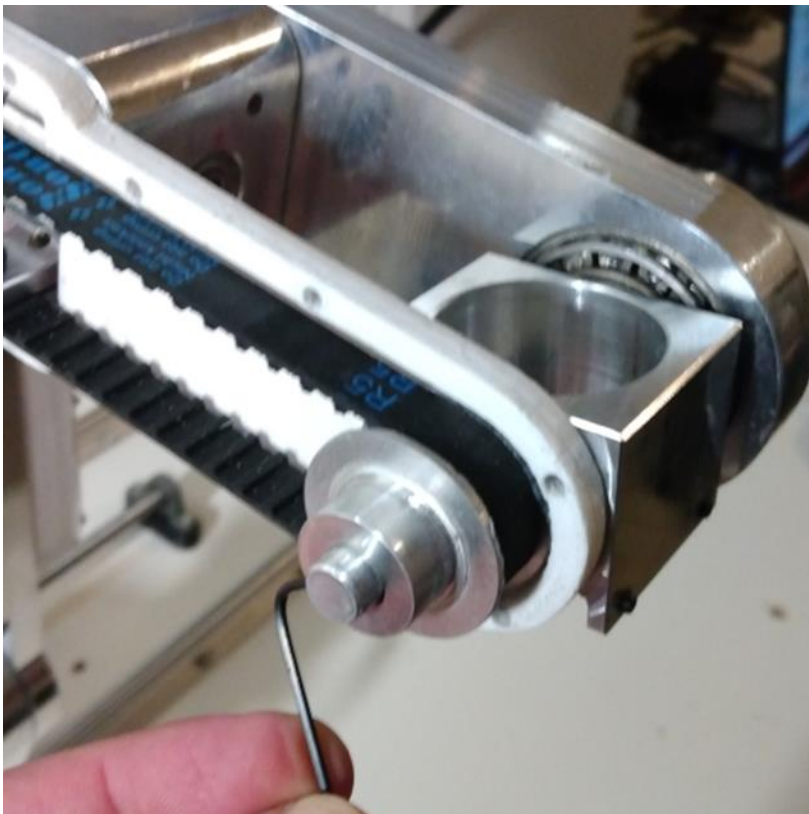

With J5 carrier in the forward position (switch clicked) and the J6 carrier at 105° tighten the XL15 pulley set screws.

The J5 angle is now mechanically calibrated.

This calibration can be refined further after the robot has been started up.



Manually rotate the J5 motor lead screw until the J6 housing is at approx. a 45° down angle – this will make installation of the J6 motor easier in a future step.

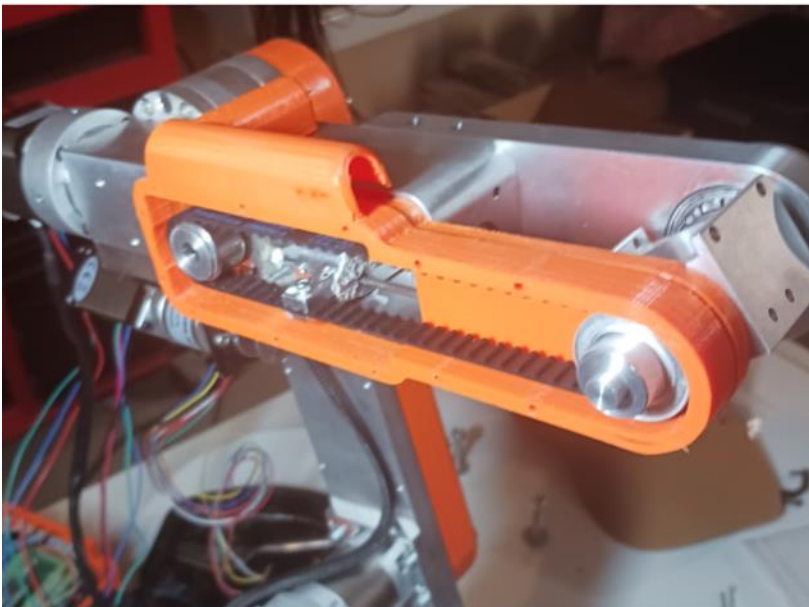

Remove the M3x25 screws that were temporarily supporting the J5 side plate then place the J5 side spacer in place as shown.

The side spacer will rest in place until the side cover and screws are installed in the next steps.

NOTE: this is an older picture and does not show the limit switch or bump stop.





Cut length of 1/4" braided sleeve to a length of 44cm long then route J5 limit switch wires through the sleeve – feed the sleeve over the wires and into the J5 side cover hump (blue arrow).

Route the J5 limit switch wire sleeve through the J5 side spacer cover and into the J2 arm cable channel as shown (red arrow).

Make sure to leave the amount of slack shown and that J4 can fully articulate (yellow arrow).

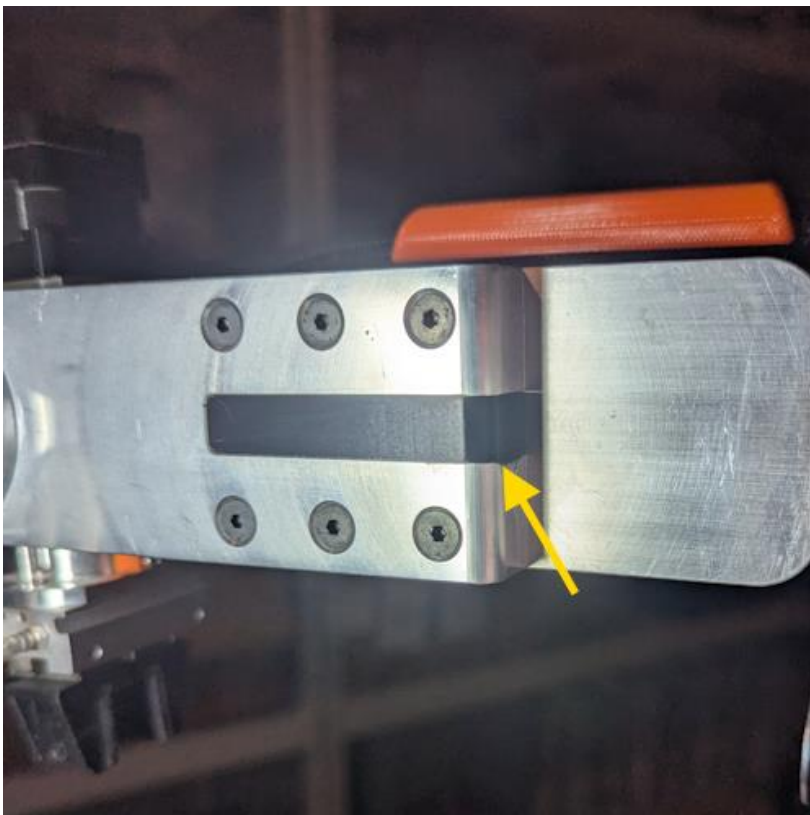

Install 3D printed J6 Main Bearing Arm Plug as shown and secure with (2) M4x10 set screws from above.

This slot was previously implemented to house an earlier version of the J5 limit switch – this plug simply blocks off the space to prevent debris from getting into the housing.

Install AR4 logo into recess in J5 side cap and secure with epoxy.



Install J5 side spacer and J5 side cap as shown and secure to J5 housing using (8) M3x25 Philips head pan screws (red arrows).





Install (4) M3x20 Philips pan head screws in front section of cap (red arrows) securing the side cover cap and side spacer to the side plate.

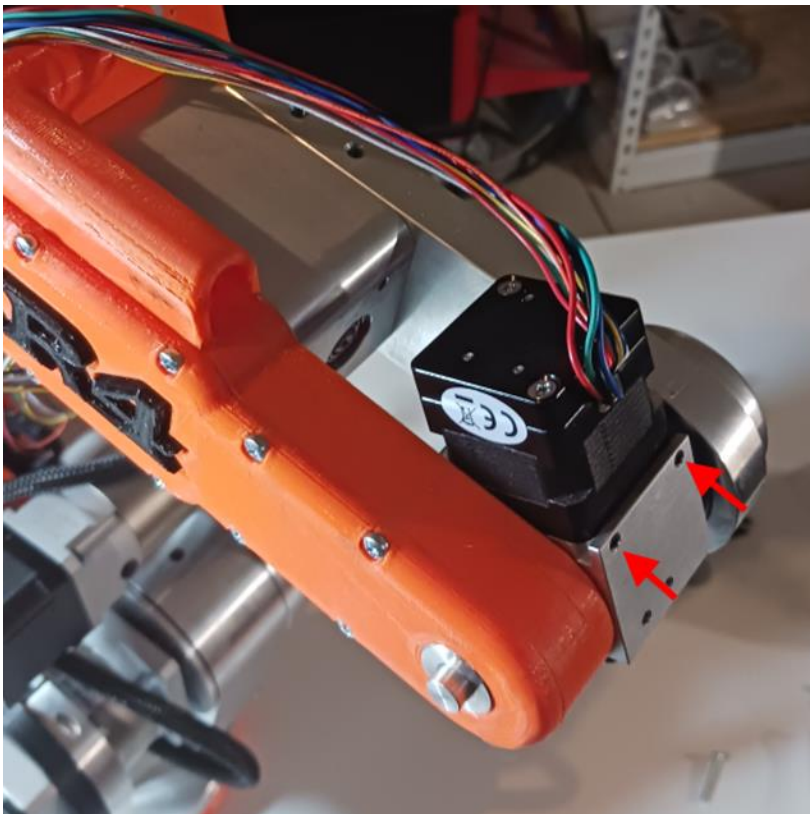

Install J6 motor into J6 housing as shown with wires facing upward.

Secure motor to housing using (4) M3x3 set screws. There are (2) in the front (red arrows) and (2) on the backside.

NOTE: MAKE SURE TO REMOVE GEARBOX DECAL AND ALL RESIDUE BEFORE INSTALLING MOTOR



Install the J6 Limit Contact onto the J6 gripper mount using (2) M2.5x8 Pan Head screws as shown.

(This will be the contact for the J6 limit switch)

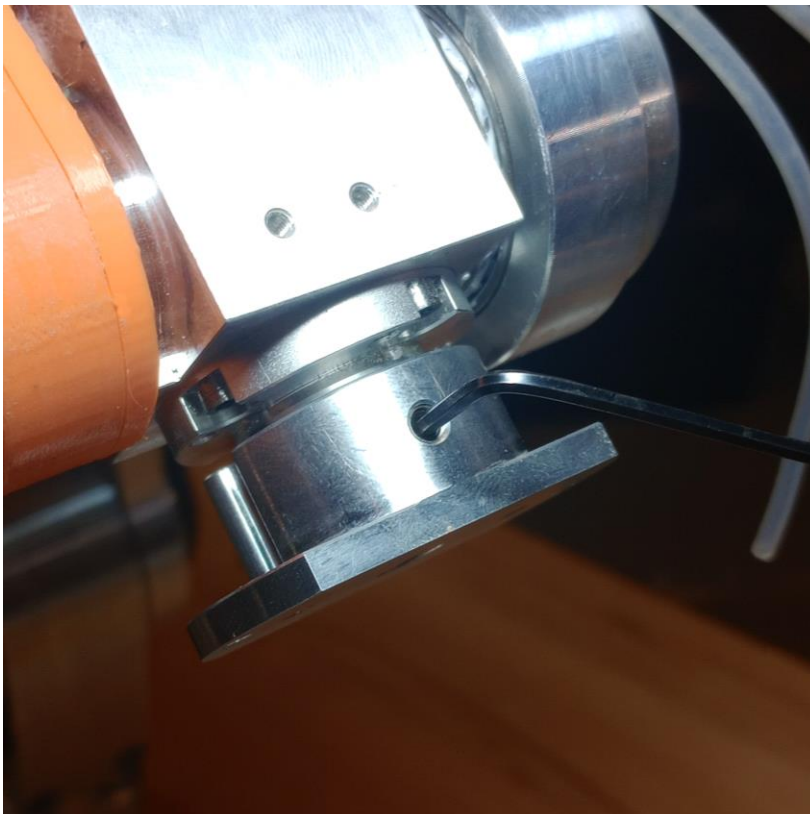

Align the slot and key on the J6 motor shaft and Install J6 gripper mount onto the J6 shaft as shown, secure with (1) M4x10 set screw.

The J6 Limit Contact should be facing toward the back.

NOTE: Review the Robot Grippers chapter in this manual to see a pneumatic and servo gripper options for the AR4 robot.



For joint 4 cut length of continuous flex Cat6 cable to a length of 117cm long and remove outer jacket. (see overview section on jacket removal)



Remove 15cm of shielding from one end of the cable and remove 17cm of shielding from the other end. (see overview section on removing shielding)

The end with 15cm of shielding removed will be the end of the cable that is routed to the base enclosure.

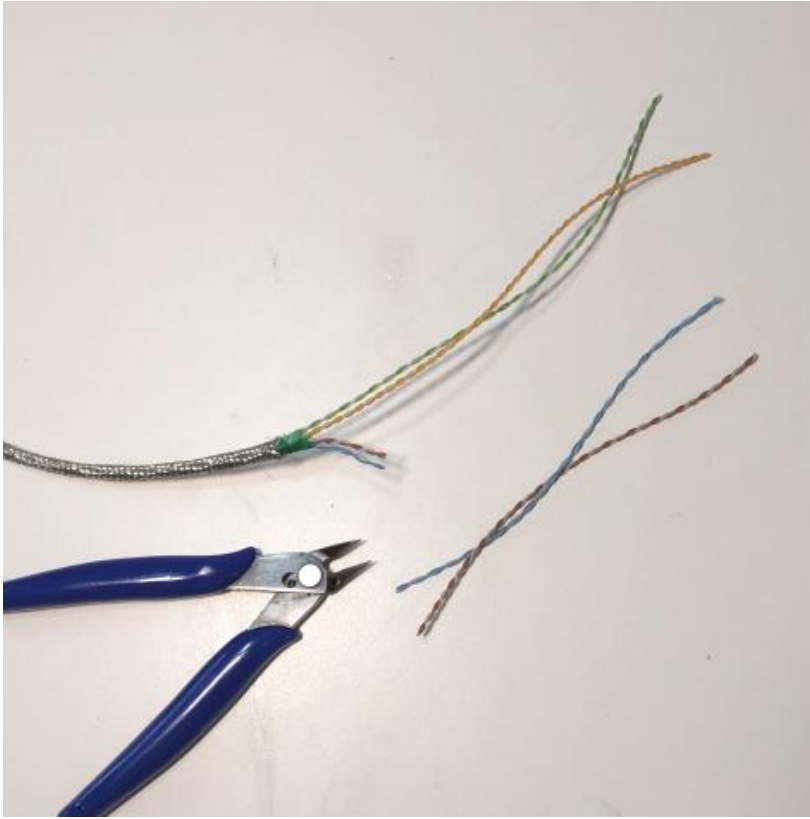

From the end of cable that has 17cm of shielding removed - cut and remove 14cm of the brown and blue twisted pairs leaving 3cm of wire exposed.



Cut length of $\frac{1}{4}$ " braided sleeve to a length of 15cm long then route green and orange twisted pairs through sleeve as shown.



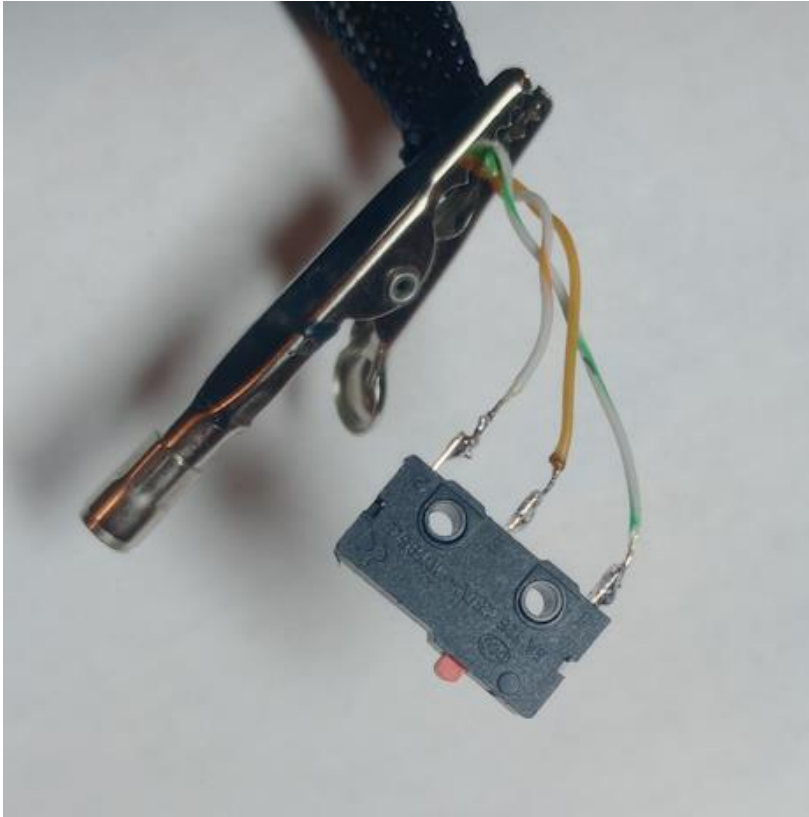

Solder orange wire to “NO” terminal of 10T85 limit switch.

Solder white with orange stripe wire to the “NC” terminal.

Solder the white with green stripe wire to the “C” terminal.

Note: the green wire is not used.

(also see wiring diagrams in chapter 4)

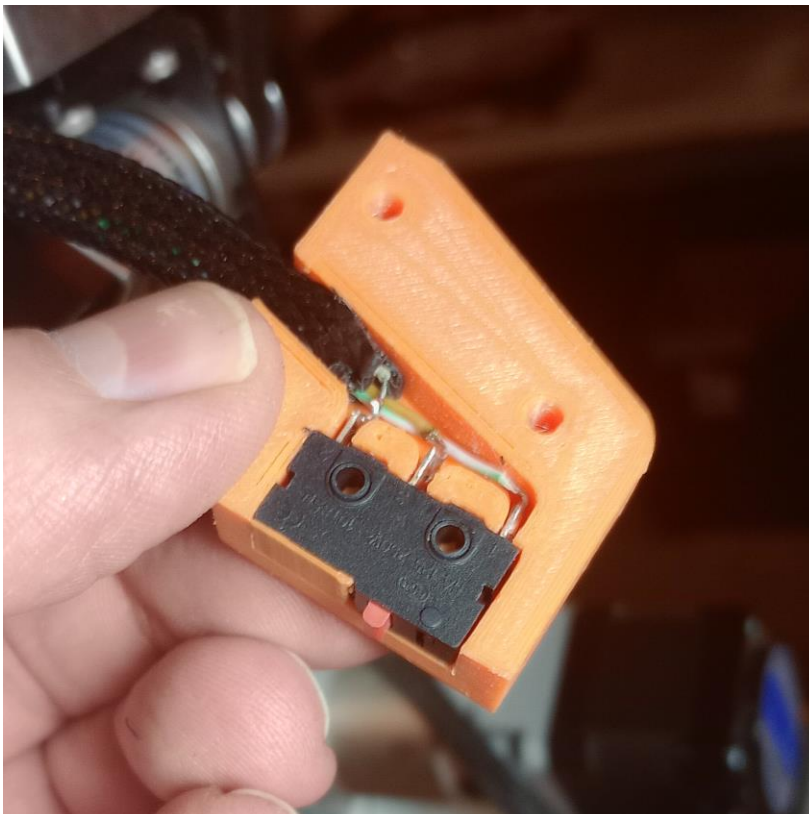

Insert J4 limit switch and connected wires into the J4 Limit Switch Motor Mount as shown.

Make sure soldered terminals and wires are recessed below the surface so there is no chance they will contact the aluminum housing in the next step. If needed you can insulate the terminals with liquid electrical tape.

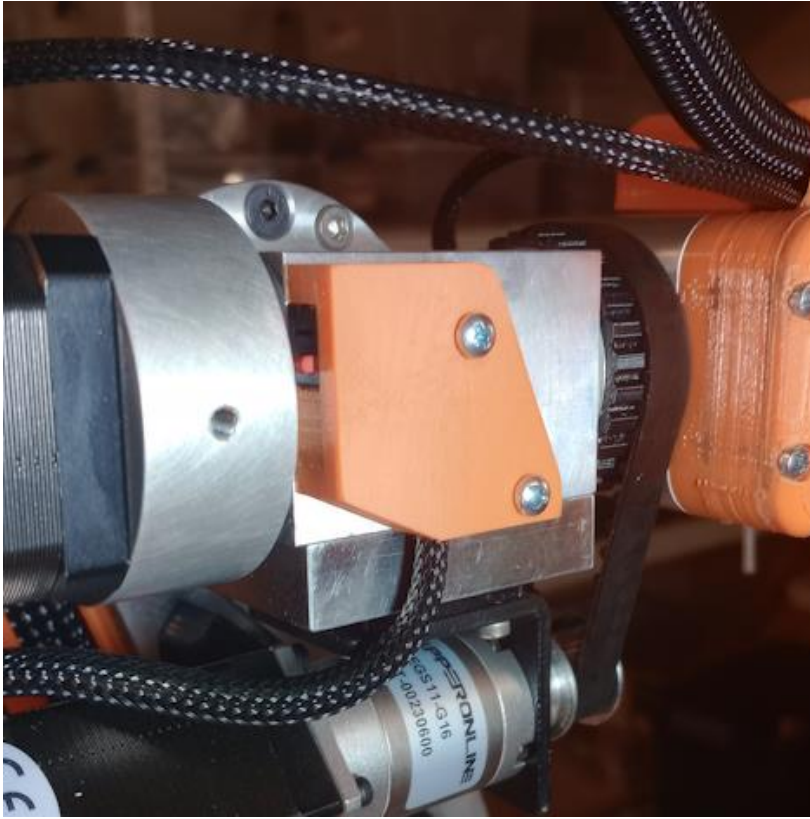

Use (2) M3x14 Philips pan head screws to secure switch mount to the J4 housing as shown in photo.

NOTE: When commissioning the robot don't forget to review the commissioning chapter – the J4 timing screw will need to be adjusted so that it correctly contact this limit switch.

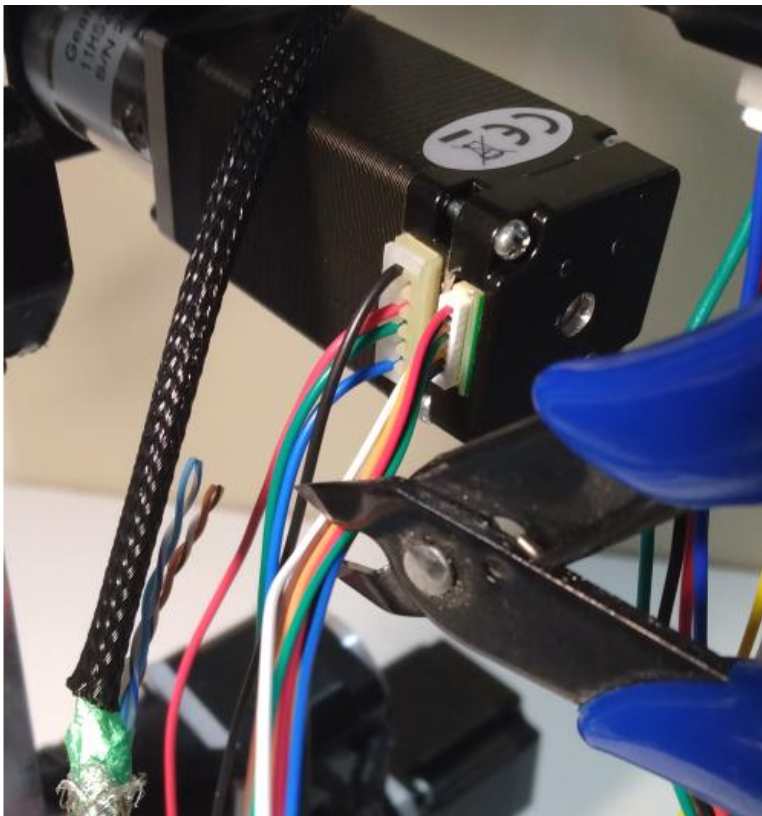

Cut the J4 encoder wires to a length of 4cm.

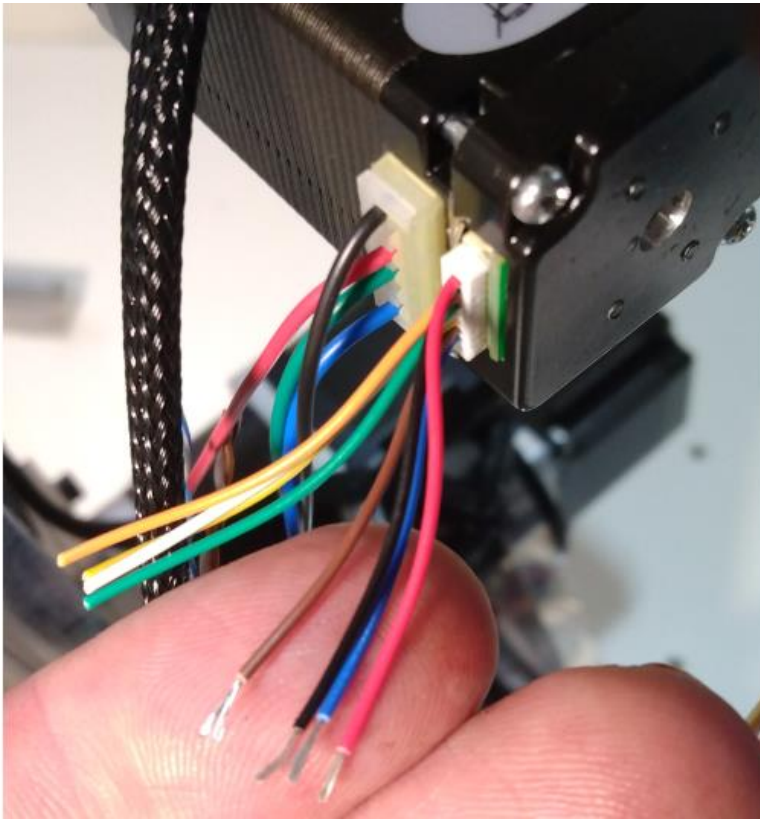

Use wire strippers to strip end of the red, black, brown and blue J4 encoder wires.

Note: only these 4 encoder wires will be used.

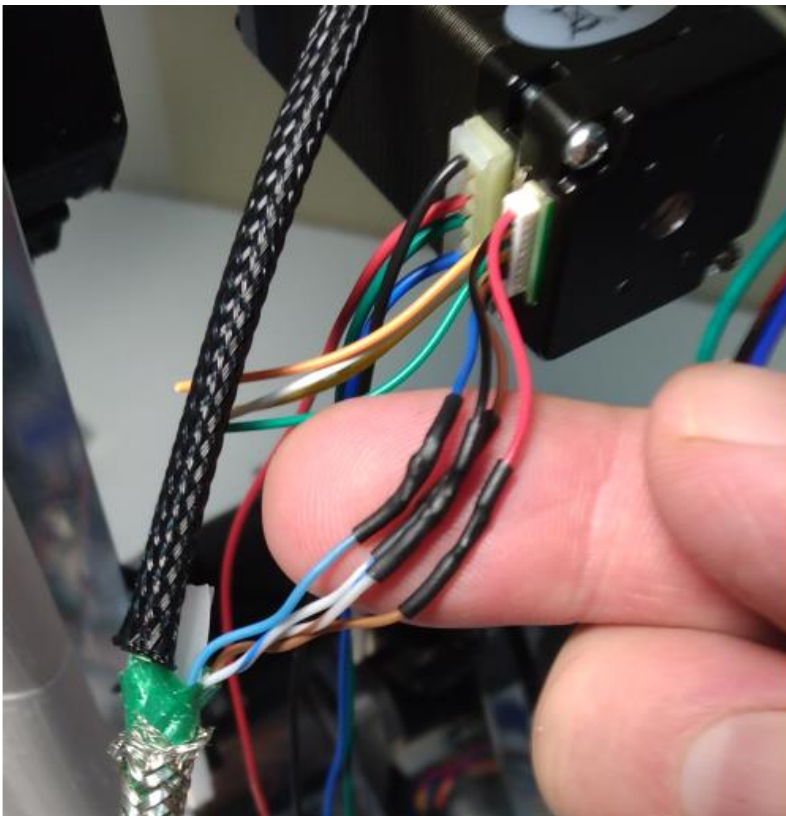

Solder and heat shrink the connection from the J4 encoder to the Cat6 cable as follows:

Encoder red wire to the cable brown wire.

Encoder black wire to the cable white – brown stripe wire.

Encoder brown wire to the cable white – blue stripe wire.

Encoder blue wire to the cable blue wire.



Cut Red, Black, Blue & Green 20awg wires to a length of 55cm long.



Solder and heat shrink 55cm long extension wires to the J4 motor wires as shown.

Be sure to match colors so that red goes to red and so on.

With the J4 motor wires extended the motor wires and Cat6 cable for J4 should now be the same length.



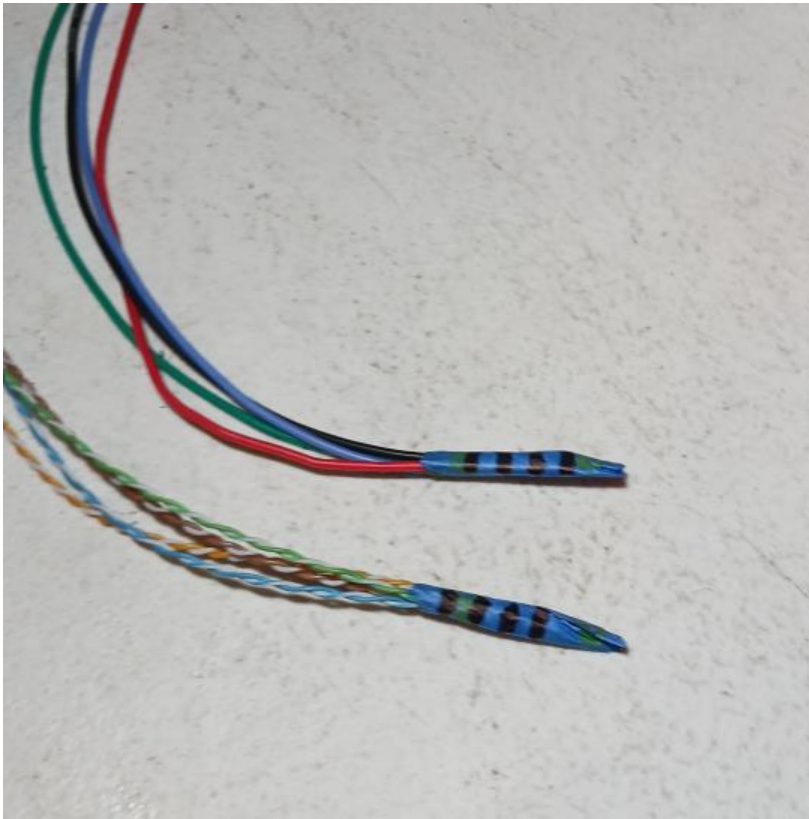

Wrap ends of J4 motor wires and J4 Cat6 cable with tape and then use a marker to put (4) stripes on each taped end so that you will know these are for J4 when wires have been routed inside enclosure

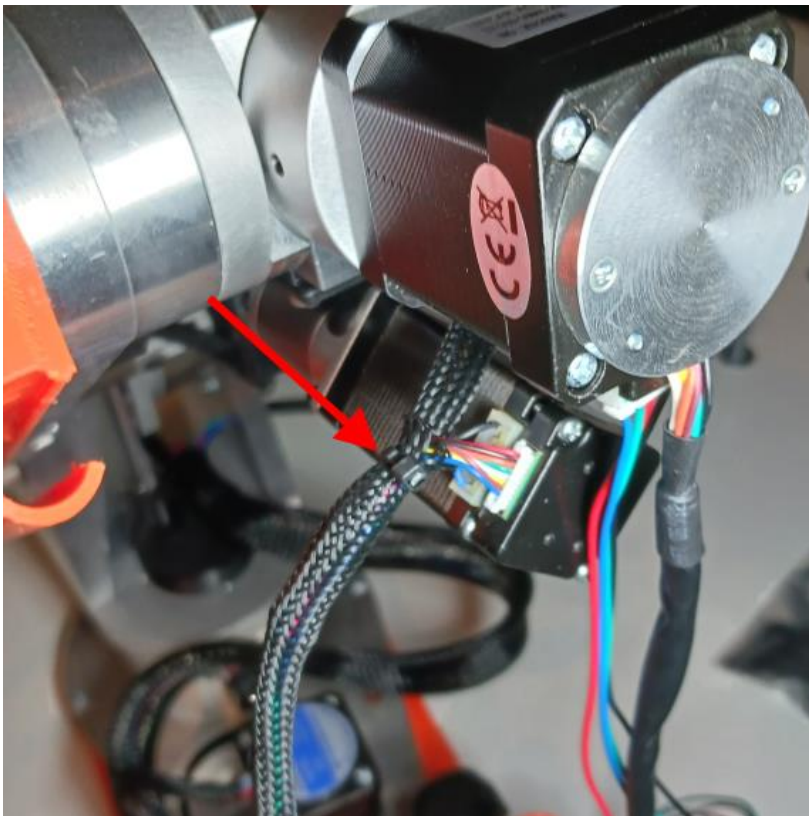

Cut length of ¼" braided sleeve to a length of 25cm long then route J4 motor wires and Cat6 cable through the sleeve.

This length of sleeve should slightly overlap the braided sleeve that goes to the J4 limit switch – use small cable tie to secure the braided sleeve where it overlaps the sleeve going to the limit switch (red arrow).

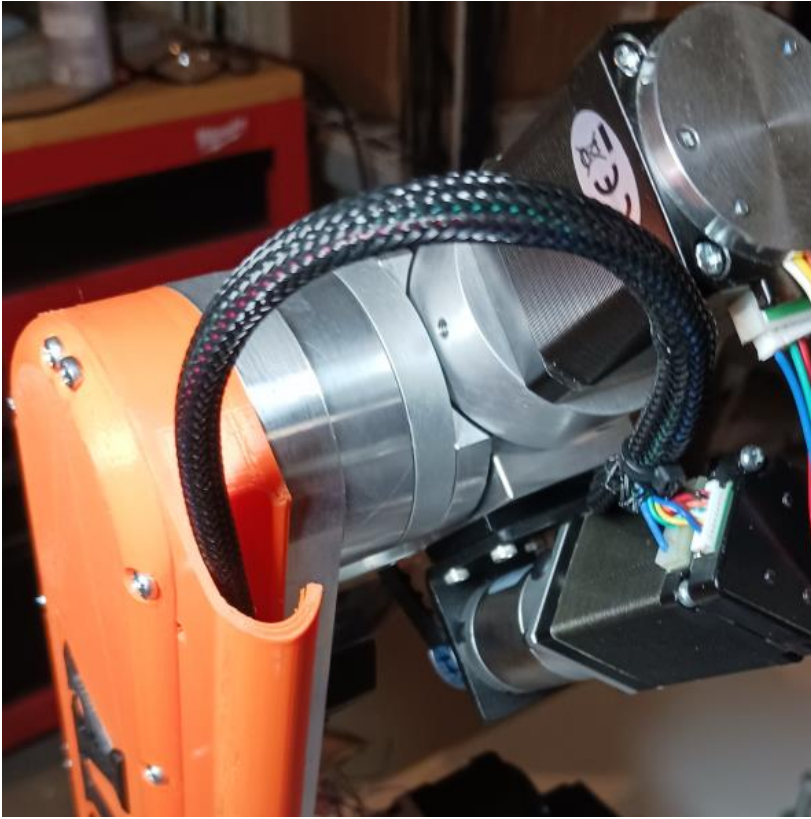

Temporarily route the J4 motor and cable wires into the J2 arm cable channel with the amount of arc and slack shown.

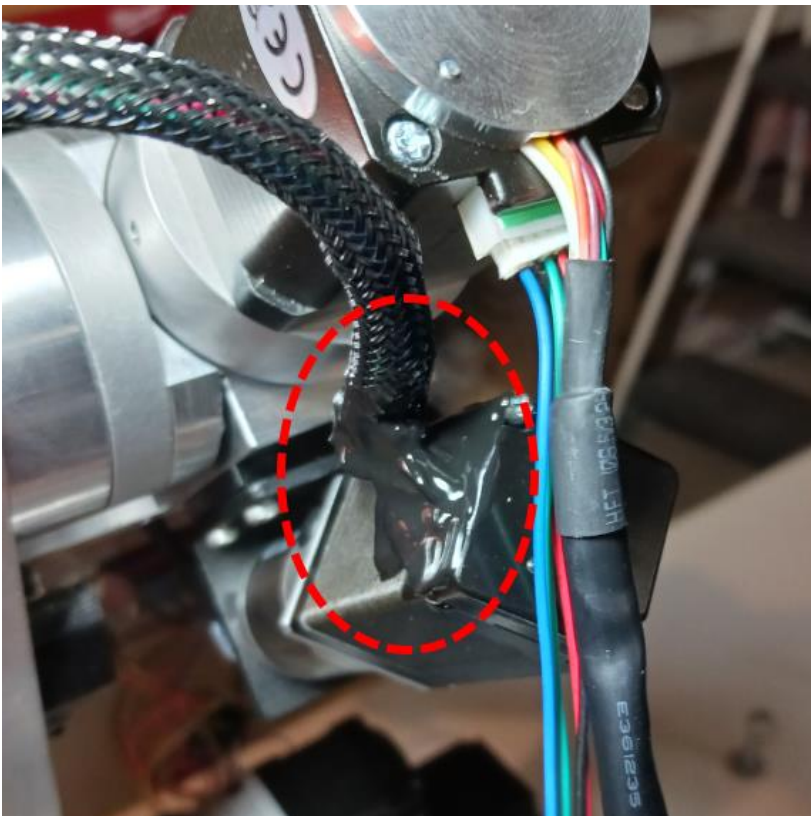

It is recommended to coat the exposed encoder and motor wires with liquid electrical tape.

Applying the liquid electrical tape can also be done later after fully testing the robot electrically.

Using the 124cm in length wires and sheilding we cut earlier for the J5 limits switch.

Cut the blue and brown twisted pairs down to a length of **120cm**.

Cut the shielding down to a length of **102cm**

Feed the brown and blue twisted pairs back through the shielding.

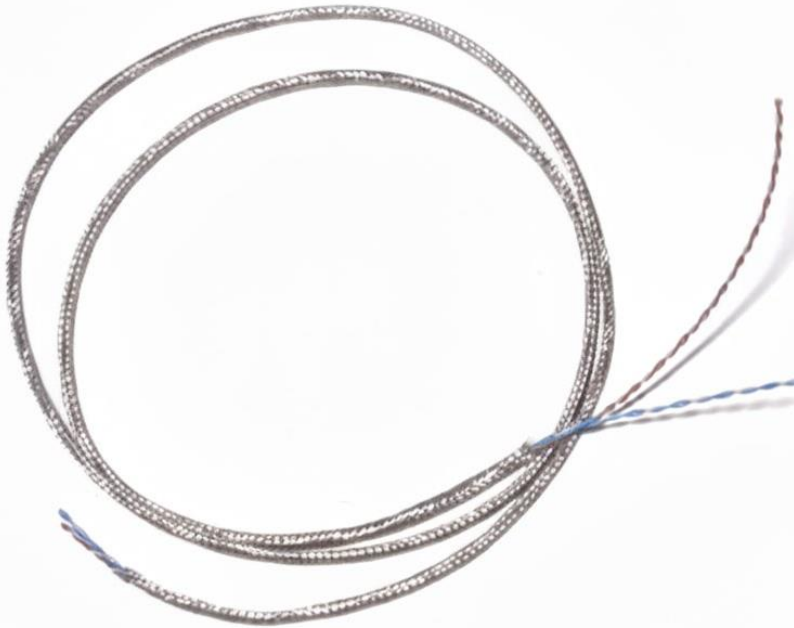

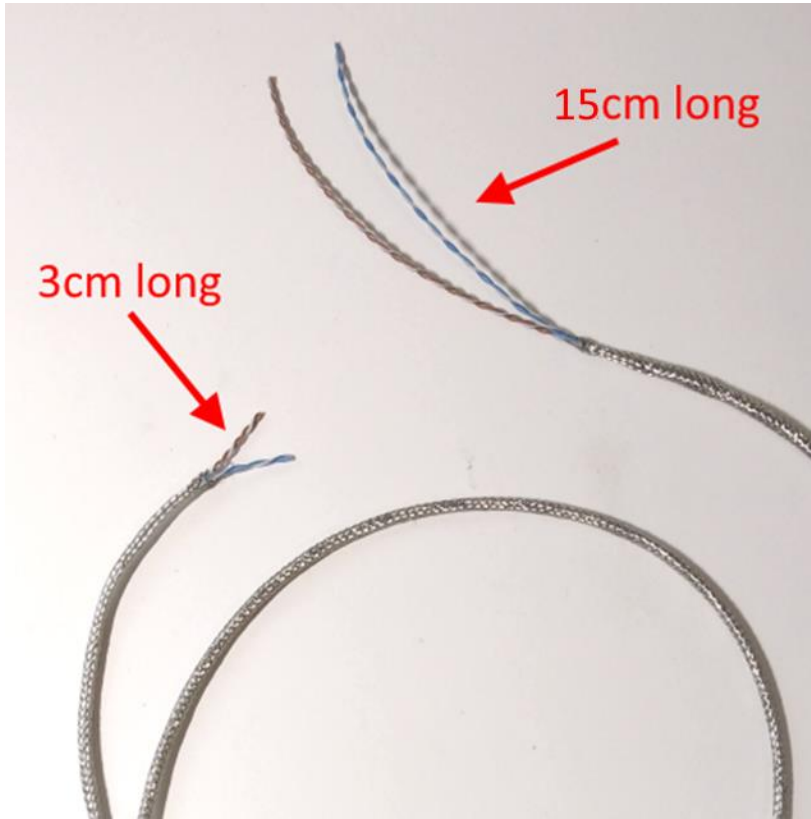

After feeding the brown and blue wire pairs through the shielding the wires should leave 15cm exposed from one end of the shielding and 3cm exposed from the other end of the shielding.

The end with 15cm of shielding removed will be the end of the cable that is routed to the base enclosure.

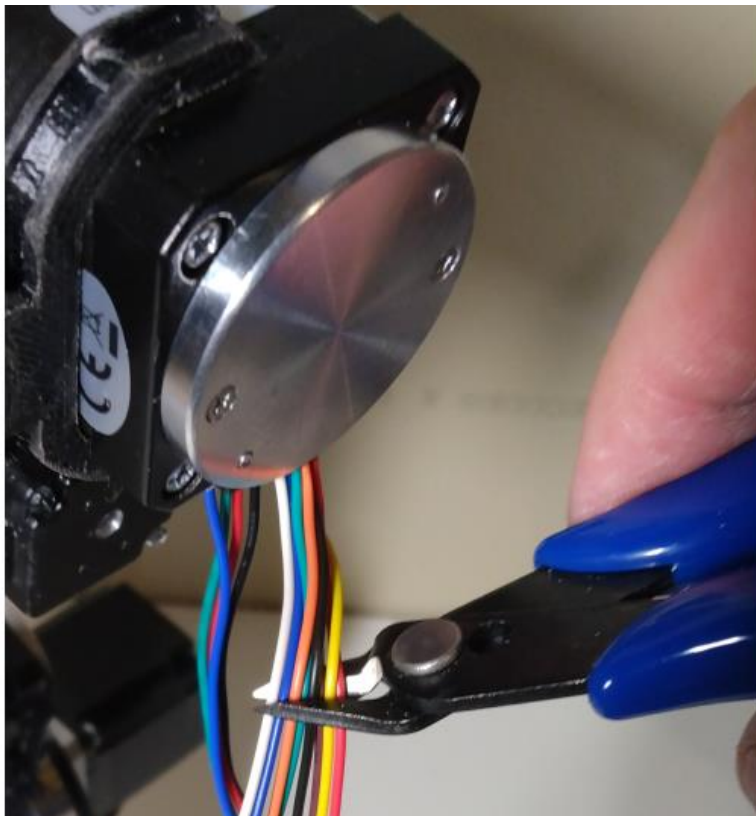

Cut the J5 encoder wires to a length of 3cm.

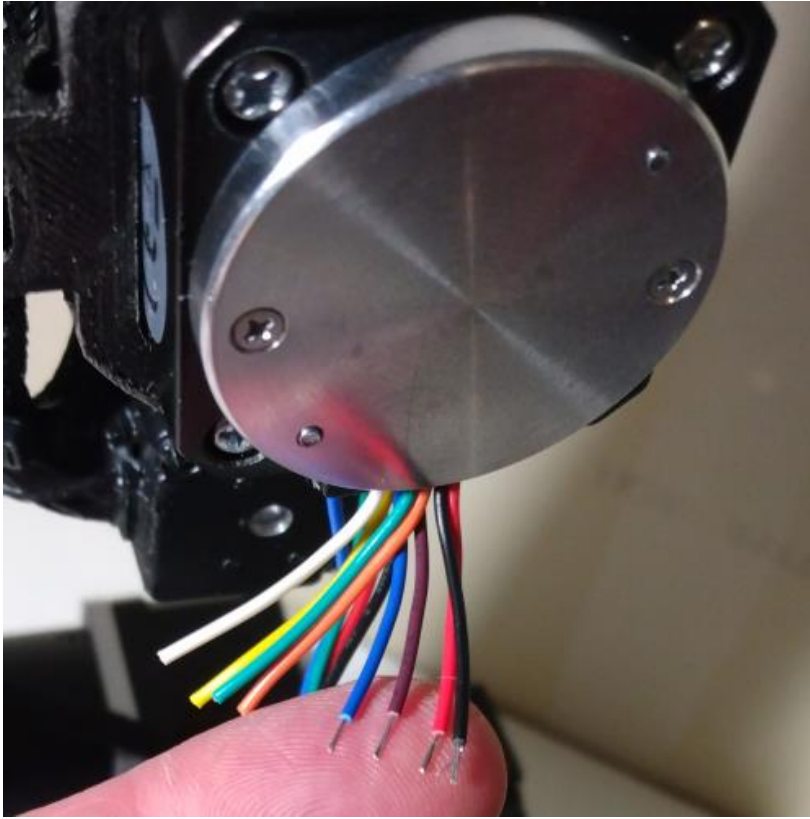

Use wire strippers to strip end of the red, black, brown and blue J5 encoder wires.

Note: only these 4 encoder wires will be used.

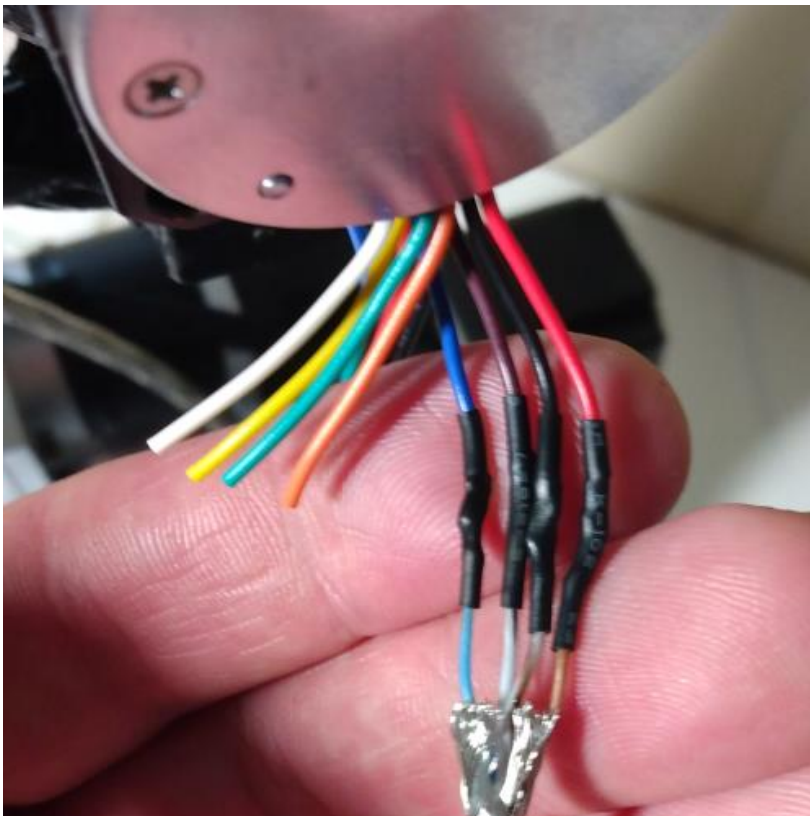

Solder and heat shrink the connection from the J5 encoder to the Cat6 cable as follows:

Encoder red wire to the cable brown wire.

Encoder black wire to the cable white – brown stripe wire.

Encoder brown wire to the cable white – blue stripe wire.

Encoder blue wire to the cable blue wire.



Cut Red, Black, Blue & Green 20awg wires to a length of 75cm long.

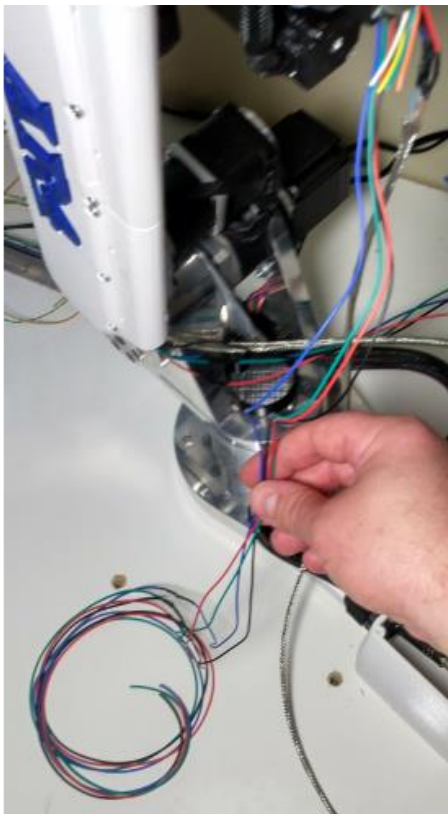

Solder and heat shrink 75cm long extension wires to the J5 motor wires as shown.

Be sure to match colors so that red goes to red and so on.

With the J5 motor wires extended the motor wires and Cat6 cable for J5 should now be the same length.



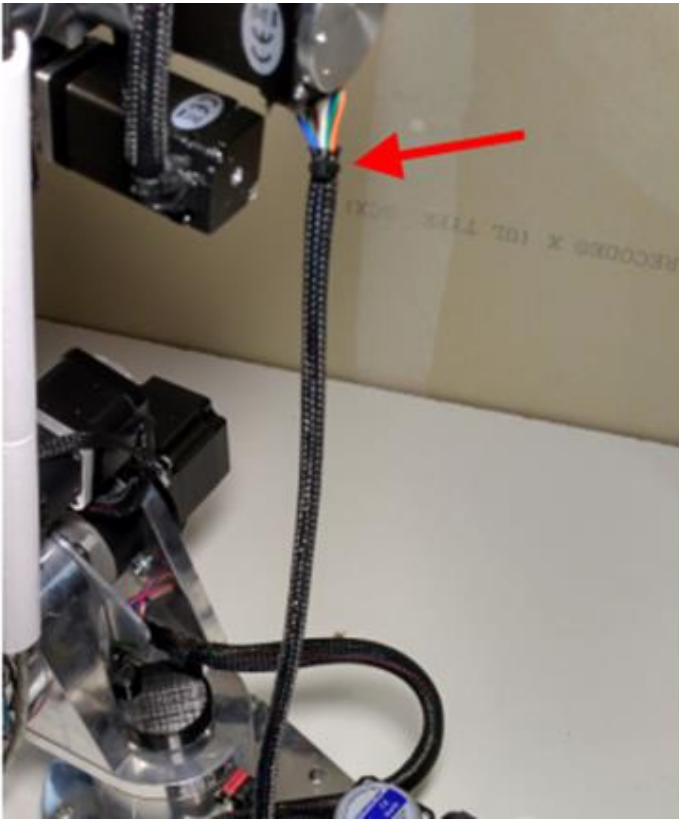

Cut length of ¼" braided sleeve to a length of 33cm long then route J5 motor wires and Cat6 cable through the sleeve.

Use small cable tie to secure the braided sleeve to motor wires and cable where shown (red arrow).



Secure the 3D printed J5 motor bracket to the J5 motor housing using a large cable tie as shown.

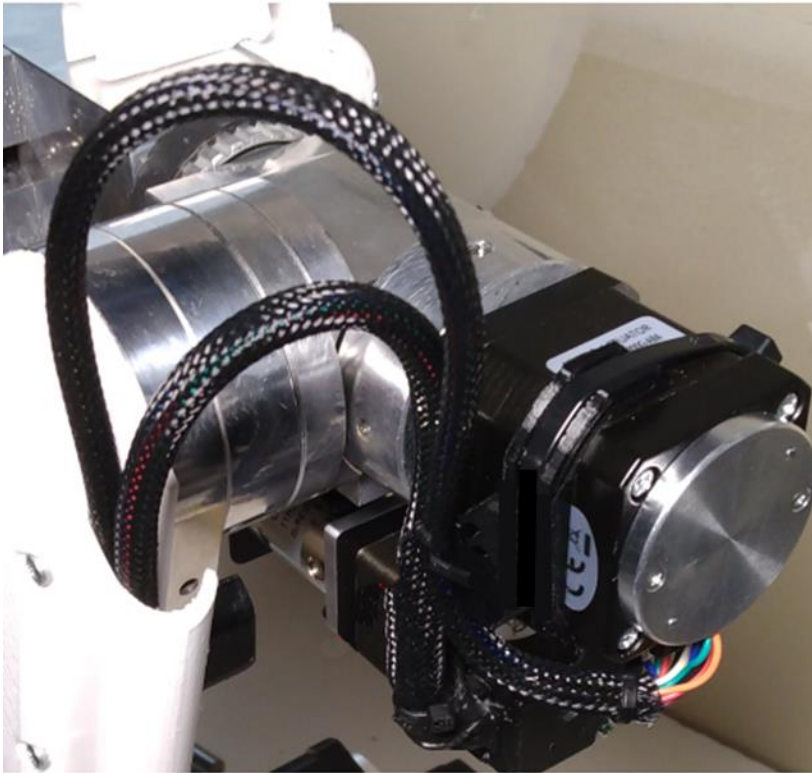

Temporarily route the J5 motor and cable wires into the J2 arm cable channel with the amount of arc and slack shown.

NOTE: the slack or amount of arc in the cable must leave enough room that J4 can fully articulate without pulling the cable.



Secure J5 wires and cable to the motor bracket with a small cable tie where shown (red arrow)

It is recommended to coat the exposed encoder and motor wires with liquid electrical tape (blue arrow).

Applying the liquid electrical tape can also be done later after fully testing the robot electrically.

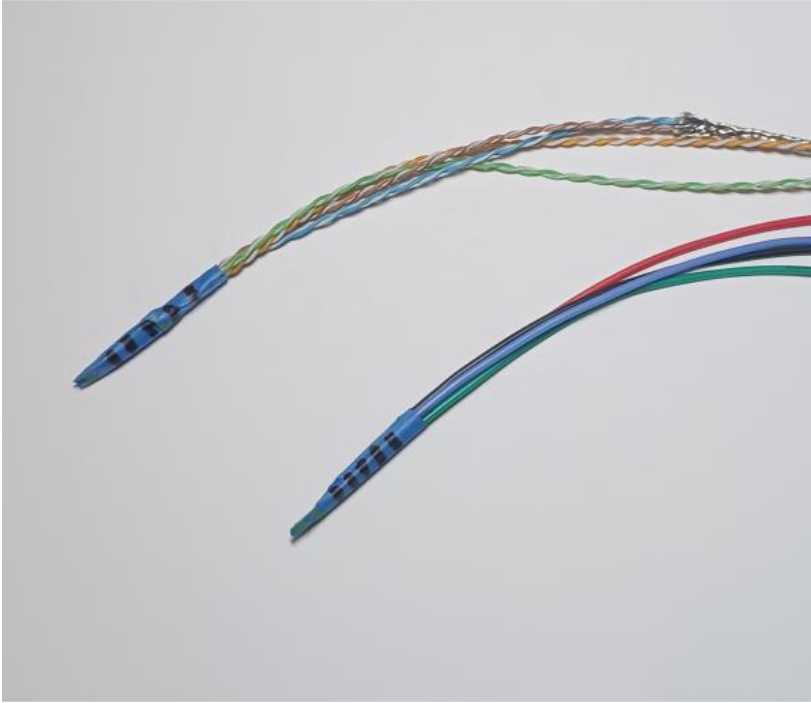

Wrap ends of J5 motor wires with tape and then use a marker to put (5) stripes on the taped end.

Combine the green and orange pairs of wires from the J5 limit switch and the blue and brown pairs from the encoder and wrap with tape, then use a marker to put (5) stripes on the taped end so that you will know these are for J5 when wires have been routed inside enclosure.



For joint 6 cut a length of continuous flex Cat6 cable to a length of 145cm long and remove outer jacket. (see overview section on jacket removal)





Remove 15cm of shielding from one end of the cable and remove 8cm of shielding from the other end. (see overview section on removing shielding)

The end with 15cm of shielding removed will be the end of the cable that is routed to the base enclosure.

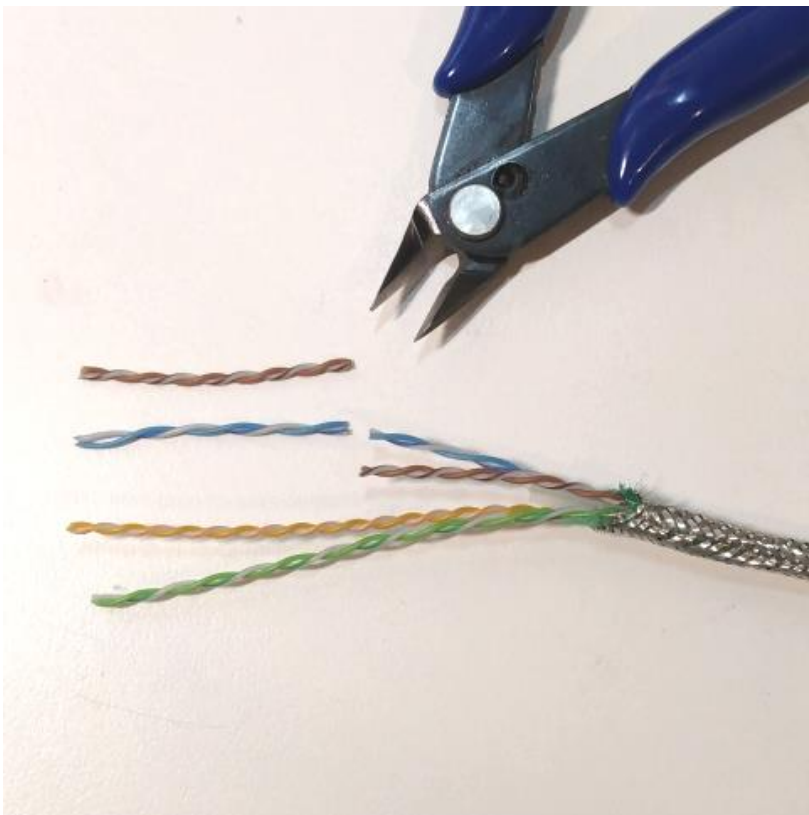

From the end of cable that has 8cm of shielding removed - cut and remove 5cm of the brown and blue twisted pairs leaving 3cm of wire exposed.

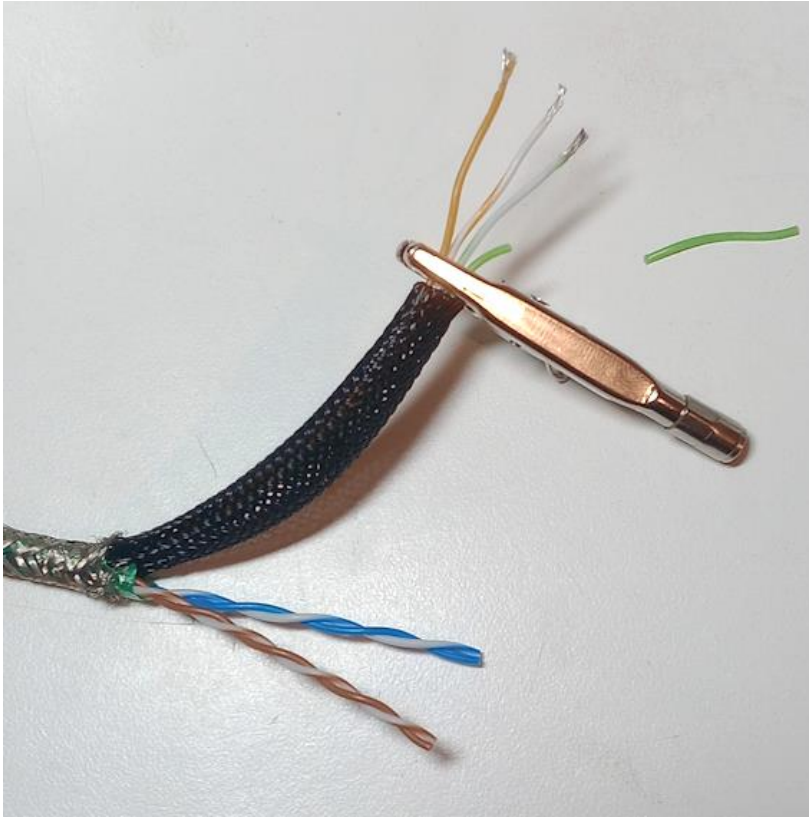

Cut length of ¼” braided sleeve to a length of 6cm

Route orange and green twisted pair through the braided sleeve – compress sleeve and use alligator clip to hold the braided sleeve back to give you room to solder wire ends to J6 limit switch.

Cut 1.5cm off of the orange twisted pair and strip all wire ends. The green wire is not used and can be cut off.

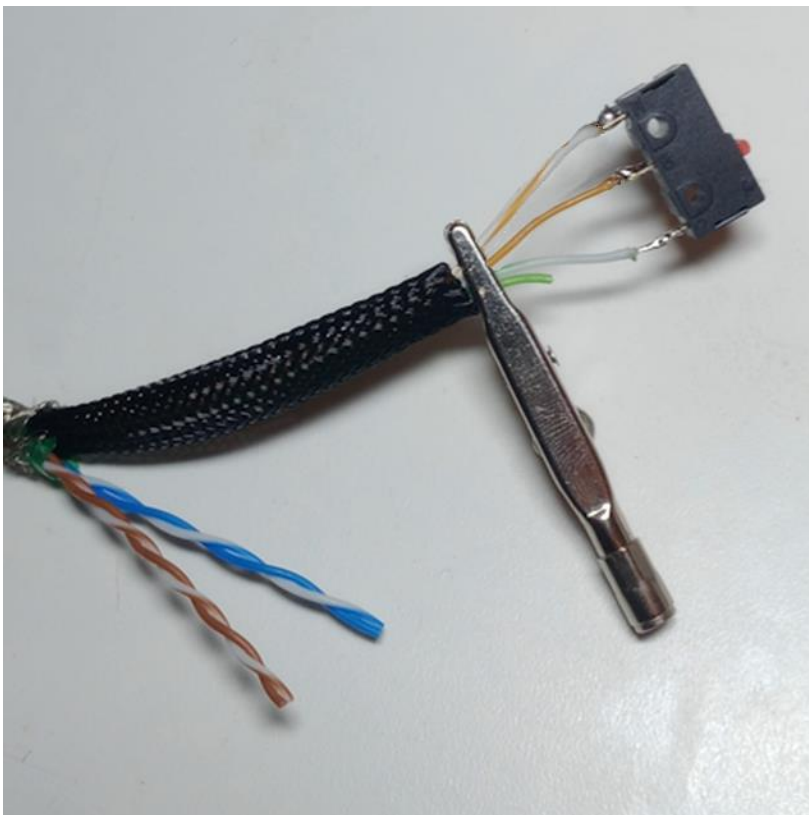

Solder orange wire to “NO” terminal of 10T85 limit switch.

Solder white with orange stripe wire to the “NC” terminal.

Solder the white with green stripe wire to the “C” terminal.

Note: the green wire is not used.

(also see wiring diagrams in chapter 4)

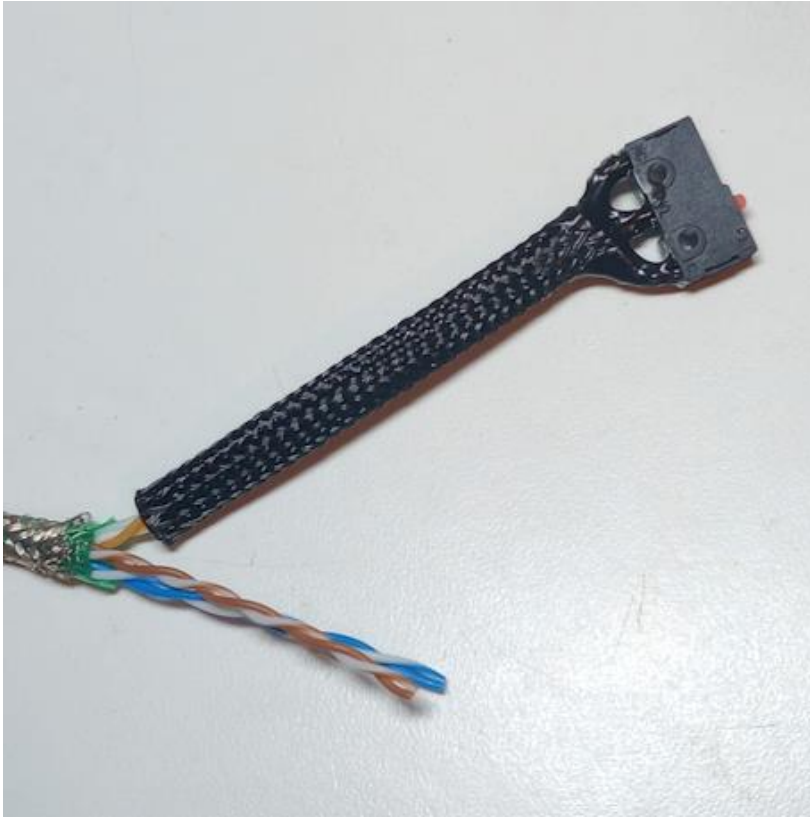

Coat switch terminals with liquid electrical tape, then remove alligator clip and allow braided sleeve to extend up to switch terminals as shown.

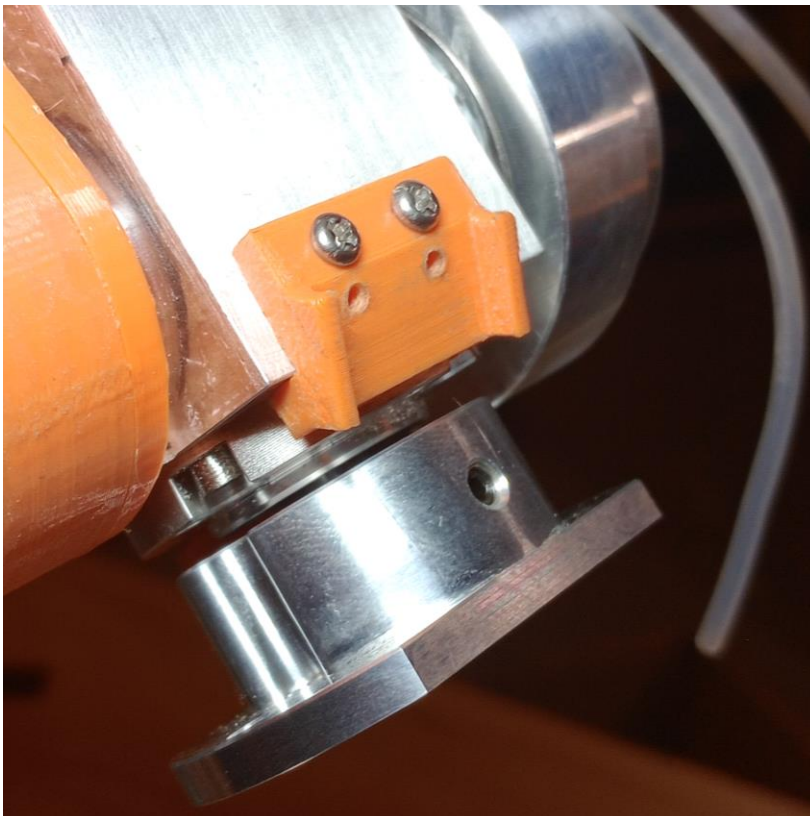

Install the J6 Limit Switch Mount onto the J6 housing and secure with (2) M2.5x6 pan head screws as shown.

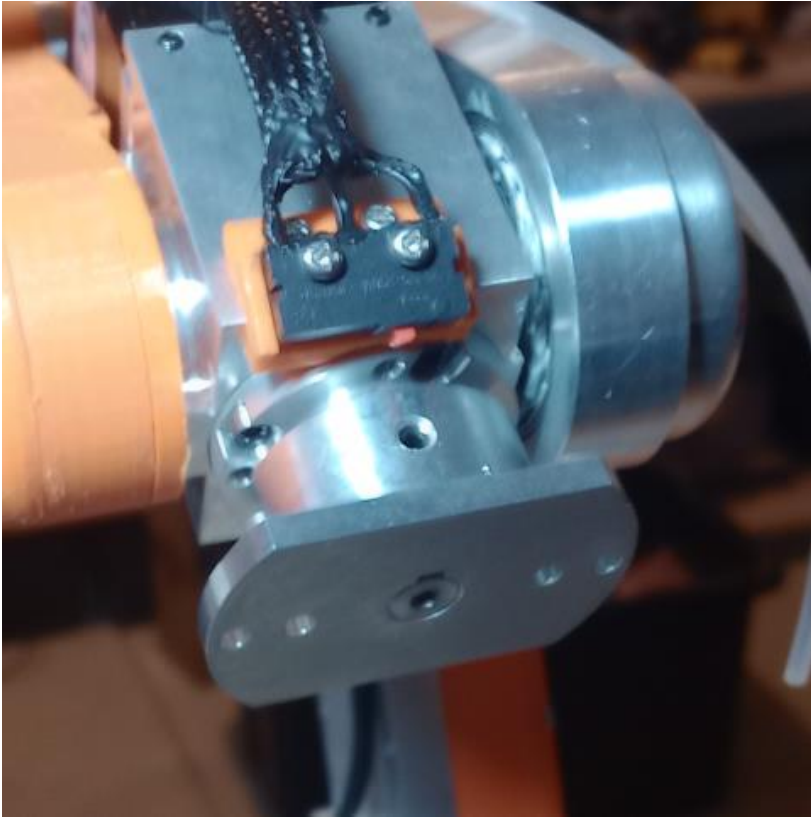

Install J6 limit switch onto J6 mount as shown using (2) M2.5x6 pan head screws.

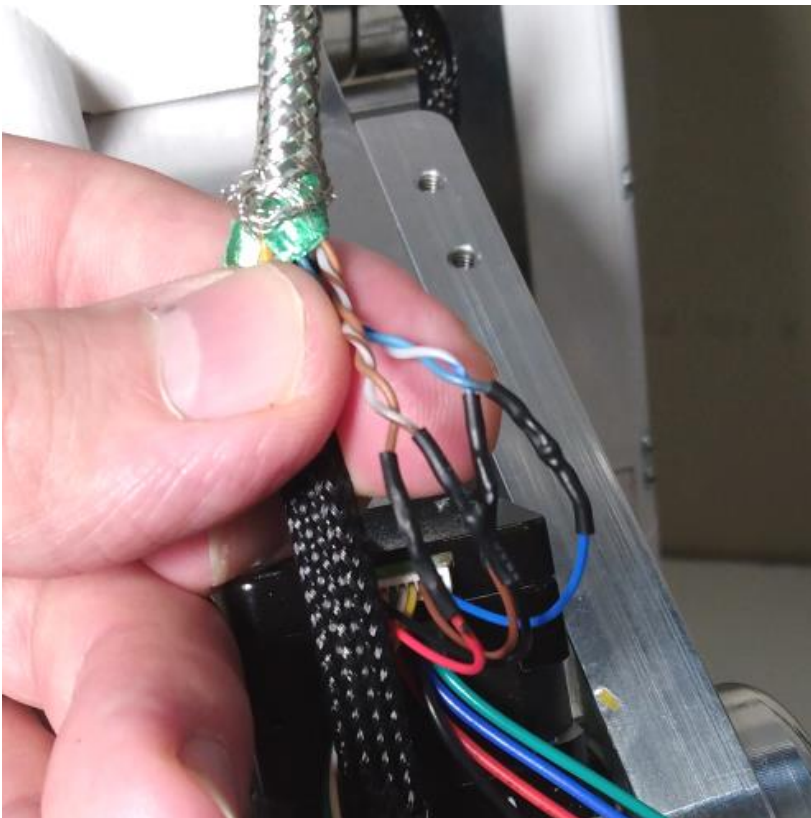

Cut the J6 encoder wires to a length of 3cm, strip ends of the red, black, brown and blue wires then solder and heat shrink the connection from the J6 encoder to the Cat6 cable as follows:

Encoder red wire to the cable brown wire.

Encoder black wire to the cable white – brown stripe wire.

Encoder brown wire to the cable white – blue stripe wire.

Encoder blue wire to the cable blue wire.



Cut Red, Black, Blue & Green 20awg wires to a length of 100cm long.

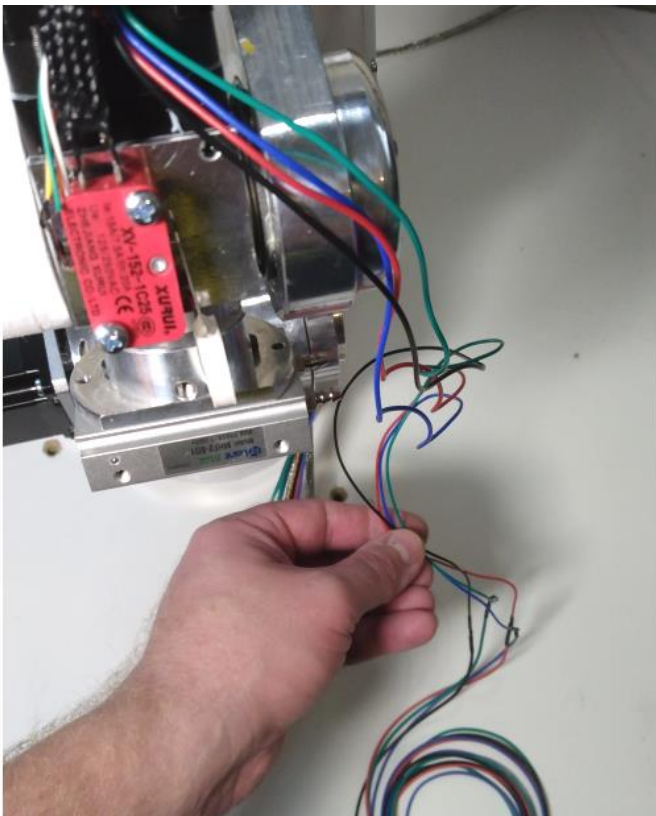

Solder and heat shrink 100cm long extension wires to the J6 motor wires as shown.

Be sure to match colors so that red goes to red and so on.

With the J6 motor wires extended the motor wires and Cat6 cable for J6 should now be the same length.

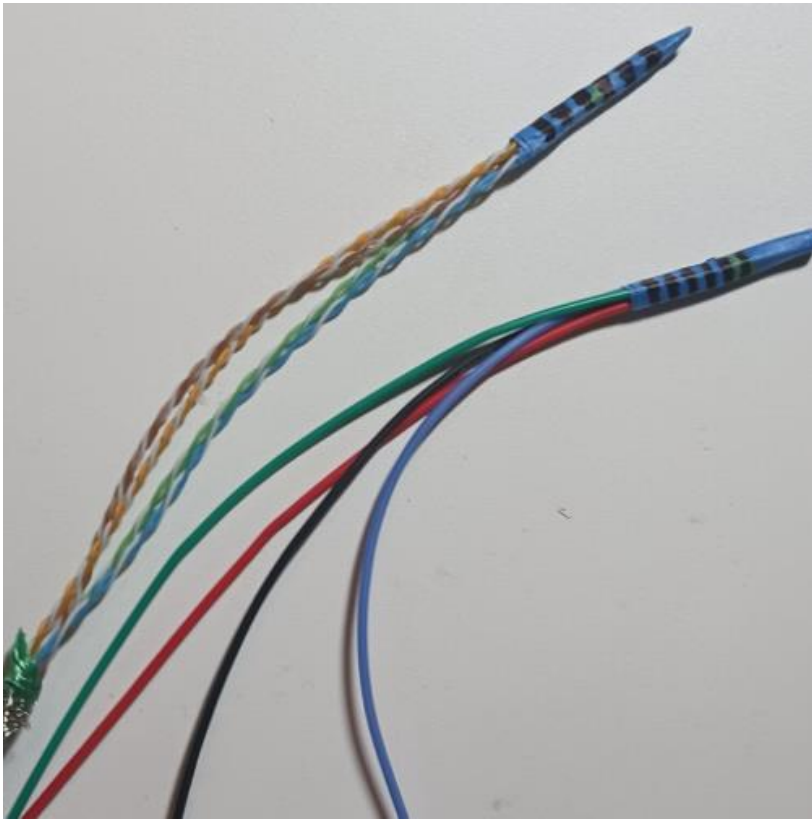

Wrap ends of J6 motor wires and J6 Cat6 cable with tape and then use a marker to put (6) stripes on each taped end so that you will know these are for J6 when wires have been routed inside enclosure.

AT THIS POINT IN THE ASSEMBLY WE NEED TO INCLUDE WIRES OR PNEUMATIC TUBING FOR ANY GRIPPER YOU WISH TO INSTALL ON THE ROBOT. PLEASE REVIEW CHAPTERS 3 AND 4 TO SEE ALL THE COMPONENTS NEEDED FOR EACH TYPE OF GRIPPER. IN THE FOLLOWING STEPS I WILL BE ADDING BOTH PNEUMATIC TUBING FOR A COMPRESSED AIR GRIPPER AND 3 CONDUCTOR CABLE FOR AN SERVO GRIPPER. YOU ONLY NEED TO INCLUDE TUBING OR CABLE FOR WHATEVER STYLE GRIPPER YOU CHOOSE.





If you wish to install a pneumatic gripper cut 2 lengths of 4mm silicone tubing to any length of your choosing. In this example I will be running 2 lengths of 350cm.

NOTE: This tubing is listed in the Chapter 3 (pneumatics gripper) Bill of Materials section.

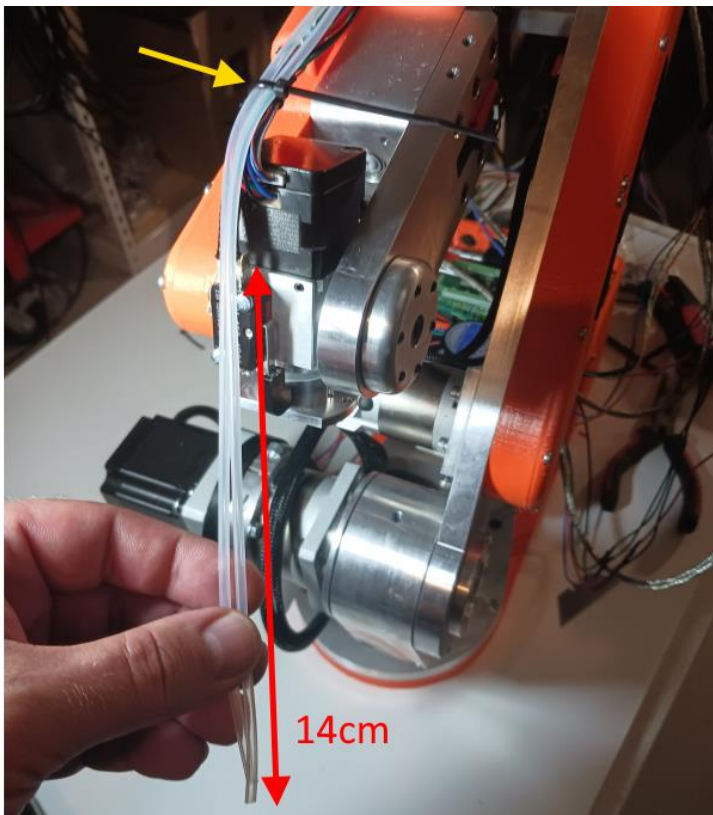

Route the 2 pneumatic lines along with the J6 motor and encoder wires as shown.

The tubes should extend past the J6 housing 14cm.

Temporarily secure the tubes to the rest of the J6 wires with a small wire tie (yellow arrow).



If you wish to install an electric servo driven gripper cut a length of 3 wire cable to a length of 175cm long.

Any stranded flexible 3 wire cable can be used. The cable I have selected is high flex 22awg (red, white, black)

NOTE: This cable is listed in the Chapter 4 (servo gripper) Bill of Materials section.

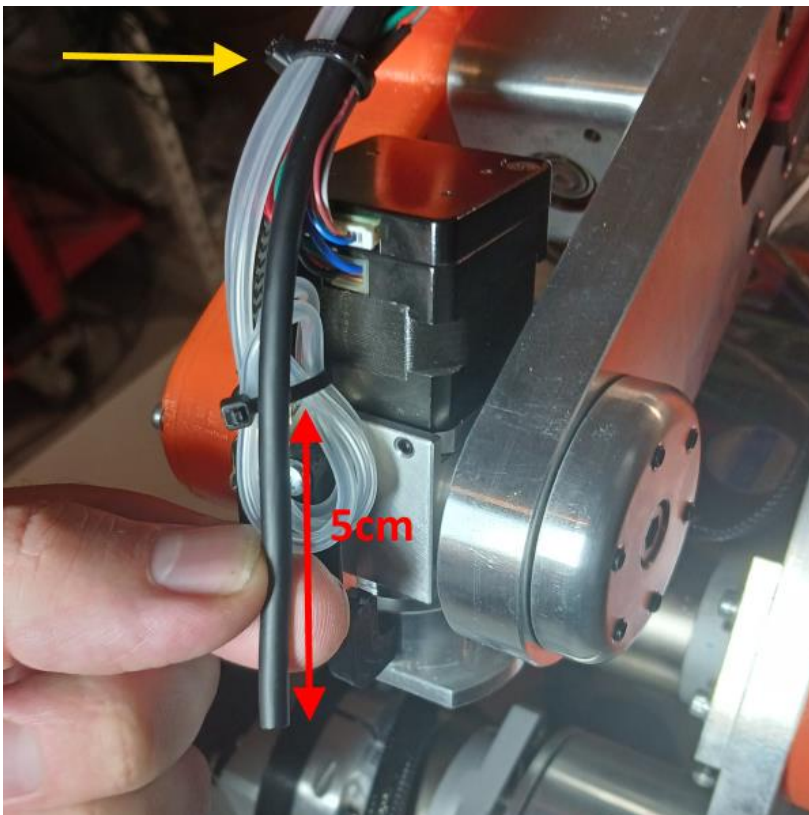

Route the 3 wire conductor along with the J6 motor and encoder wires as shown.

The cable should extend past the J6 housing 5cm.

Temporarily secure the tubes to the rest of the J6 wires with a small wire tie (yellow arrow).

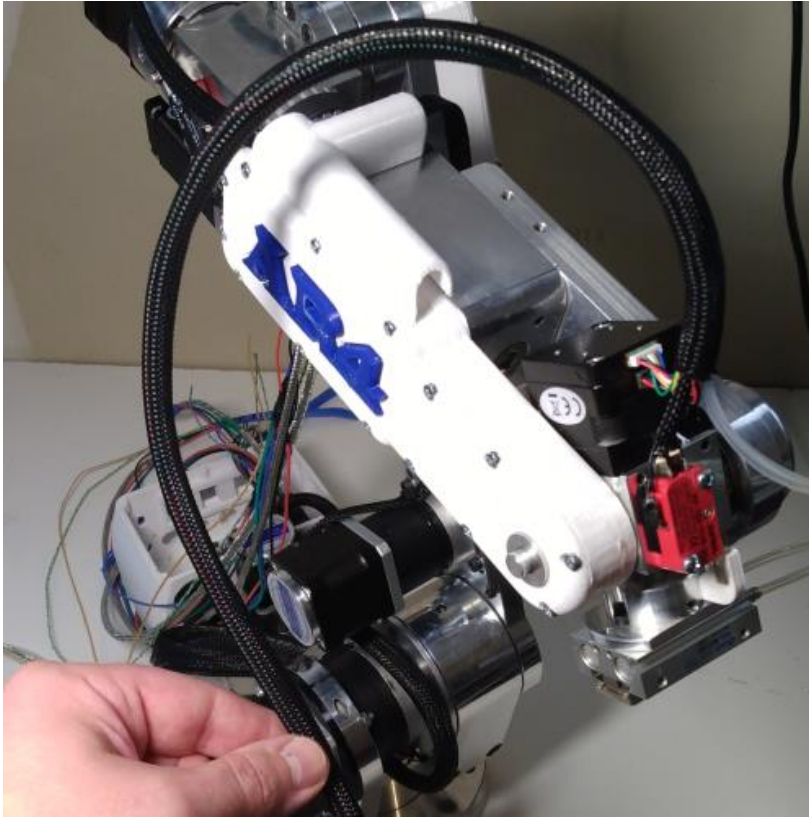

Cut length of ¼” braided sleeve to a length of 90cm long then route J6 motor wires, encoder wires, as well as pneumatic tube or gripper conductor cable through the sleeve.

Getting all these wires routed through the braided sleeve can be difficult, it helps to make sure all the wires are laid straight and not crossing over or twisted. It helps to wrap painters tape over the end of the tubes and wrap the bundle anywhere a wire ends.



Route J6 wires and sleeve through the J5 side spacer wire way as shown. Make sure to leave the amount of slack shown and that J5 can fully articulate.

If you have trouble getting the wire sleeve bundle through the side spacer channel you can remove the side cover, tuck the bundle into the spacer channel and then reinstall.

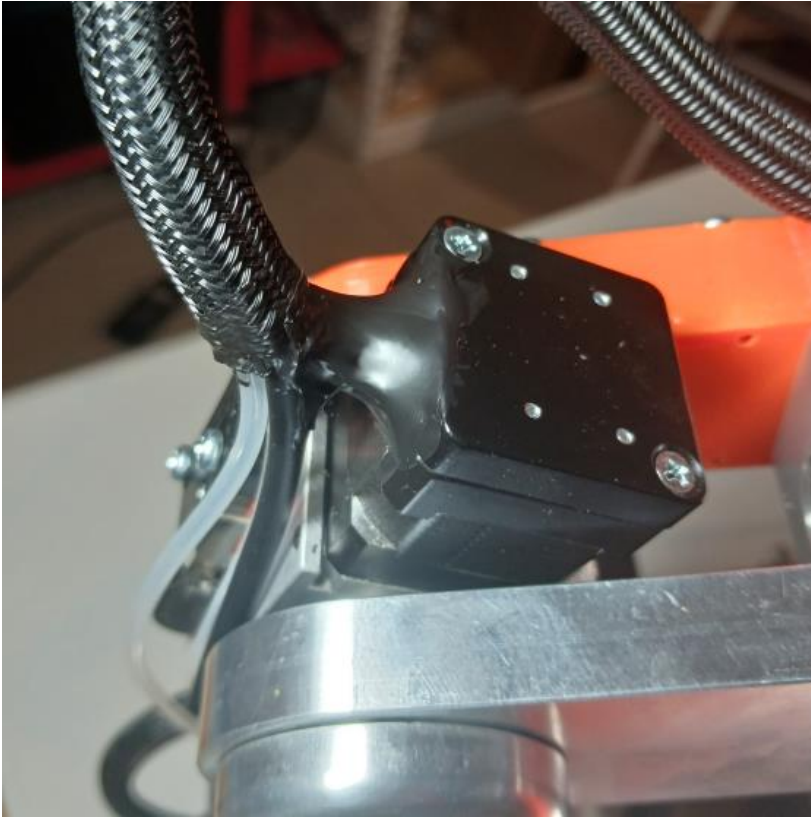

It is recommended to coat the exposed encoder and motor wires with liquid electrical tape.

Applying the liquid electrical tape can also be done later after fully testing the robot electrically.



Route the J6 cable along with the J5 limit switch cable so that they are the same length and feed into the J2 side cover wire way as shown. Make sure they maintain the amount of slack shown so that J4 can fully articulate.

Make sure the J4 and J5 motor cables maintain the correct amount of slack and then bind all the cables together temporarily with a small cable tie as shown.



Cut length of 3/4" braided sleeve to a length of 70cm long then route J4, J5 and J6 motor wires and Cat6 cables through the sleeve.

Where the 3/4" braided sleeve overlaps the braided sleeve for the J4,5,6 cables just below the small cable tie wrap the end of the 3/4" braided sleeve with electrical tape. (red arrow)



Insert the complete harness back into the J2 wireway as shown.

Secure wire harness to wireway with 4 small cable ties (red arrows).

The top cable tie should overlap the harness where the wrap of electrical tape is at.

Carefully remove the cable tie that was used to temporarily keep the 4 smaller cables together.



Next we need to route all the J4, J5, J6 wires into the enclosure.

Start with the pneumatic lines, they need to be routed through the right PG21 gland nut, below the tray, along side the J6 driver and then out the slot in bottom right of base enclosure.

The servo gripper cable needs to be routed above the tray, to the right of the teensy breakout board and out the round hole on right rear of the tray.

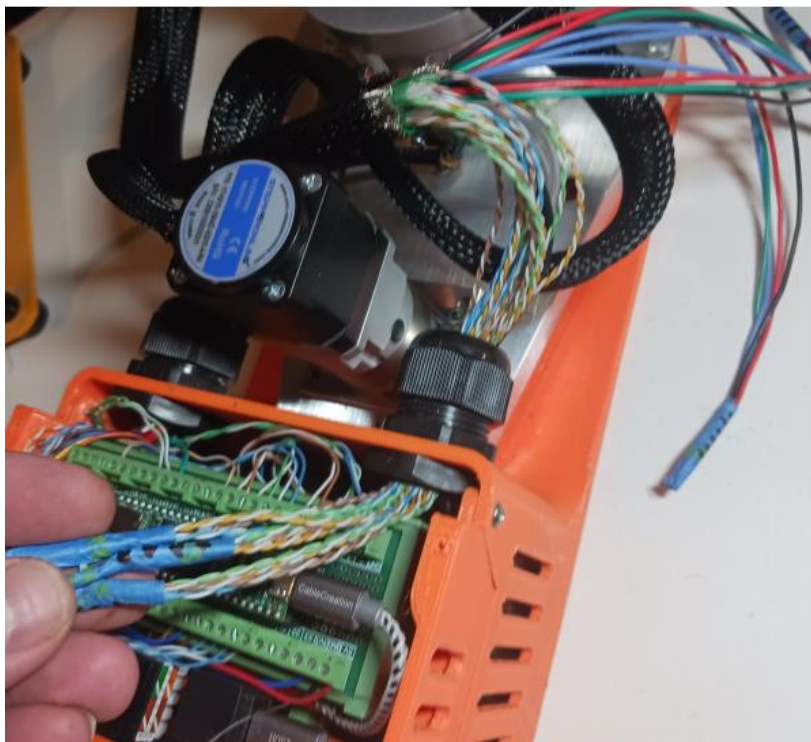

Route the J4, J5 and J6 encloser CAT6 wires through the PG21 gland nut and then above the tray.

NOTE: a small pair of needle nose pliers can help to gasp the wire ends to pull them through (be careful not to pull the label tape off)





Route the J4, J5 and J6 motor wires through the PG21 gland nut and then below the tray.

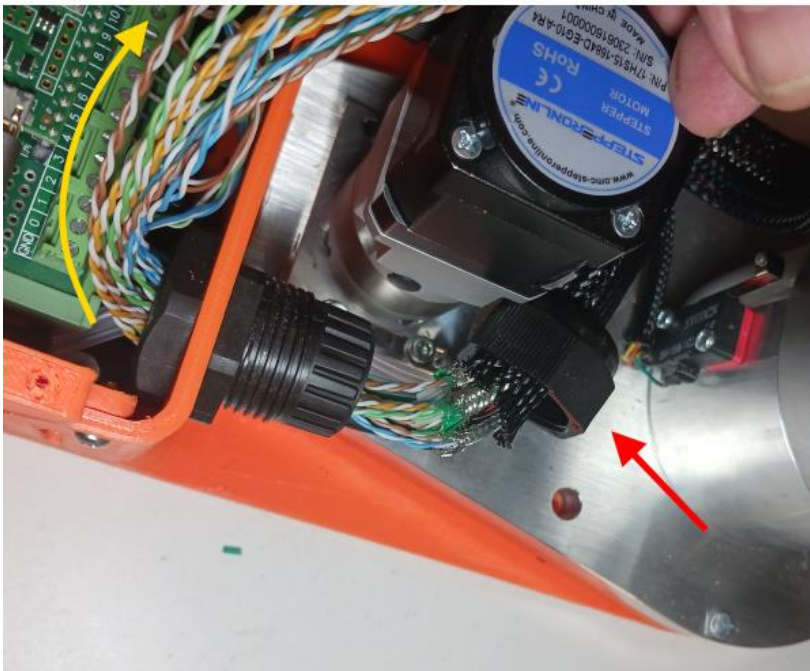

Move the gland nut back over the sheathing (red arrow) and continue to feed all wires into the enclosure, you will need to pull the motor, encoder and gripper wires through as you feed the bundle into the gland nut.



Once you have finished pulling the wires through and feeding the bundle into the gland fitting, tighten the gland nut as shown.

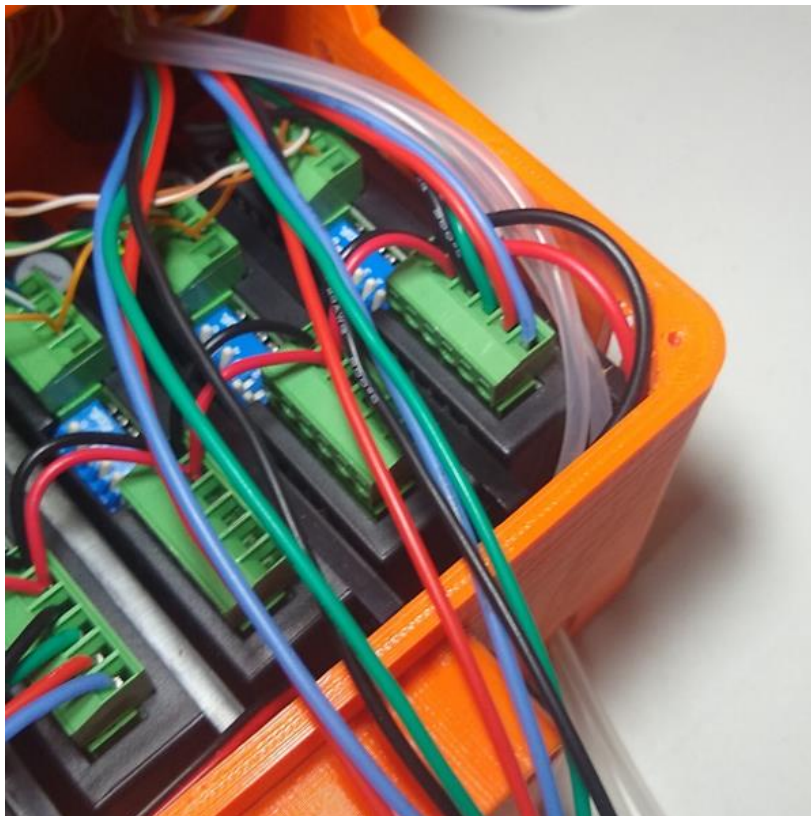

Find the motor wires that were taped with 6 marks for J6 then route and cut the wires as shown so that they are the appropriate length to reach the J6 driver terminals.

Connect the (4) J6 motor wires to the J6 driver terminals as follows:

A+ BLACK

A- GREEN

B+ RED

B- BLUE

NOTE: also see schematics chapter for wiring diagram

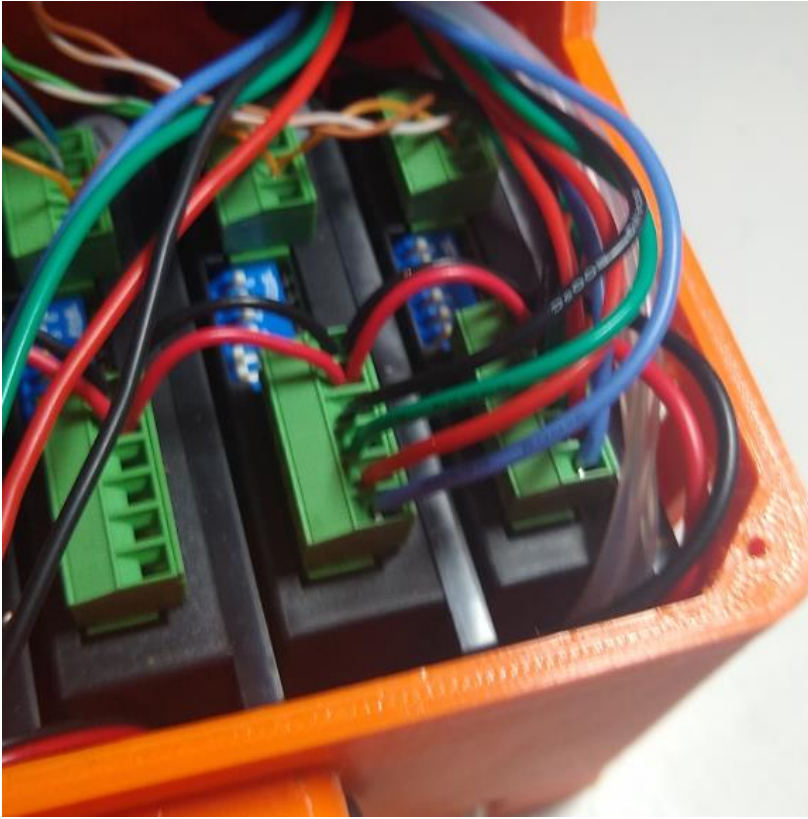

Find the motor wires that were taped with 5 marks for J6 then route and cut the wires as shown so that they are the appropriate length to reach the J5 driver terminals.

Connect the (4) J5 motor wires to the J5 driver terminals as follows:

A+ BLACK

A- GREEN

B+ RED

B- BLUE

NOTE: also see schematics chapter for wiring diagram

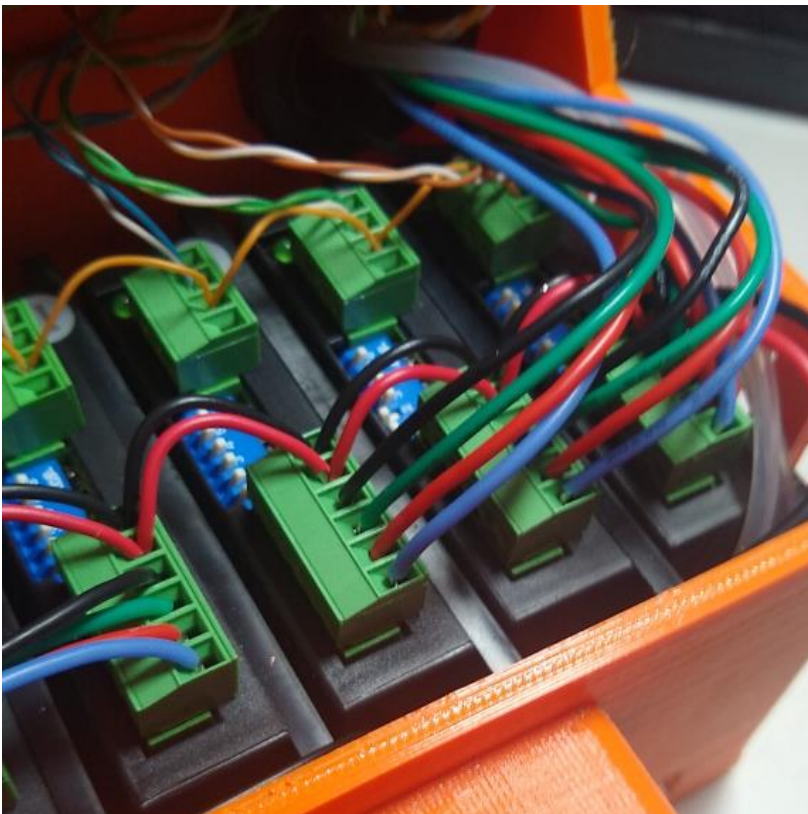

Find the motor wires that were taped with 4 marks for J4 then route and cut the wires as shown so that they are the appropriate length to reach the J4 driver terminals.

Connect the (4) J4 motor wires to the J4 driver terminals as follows:

A+ BLACK

A- GREEN

B+ RED

B- BLUE

NOTE: also see schematics chapter for wiring diagram



Use a small cable tie to bundle the J4, J5, J6 and pneumatic lines on right side of base enclosure as shown (yellow arrow).

Make sure not to overtighten cable tie and pinch or collapse pneumatic air lines.

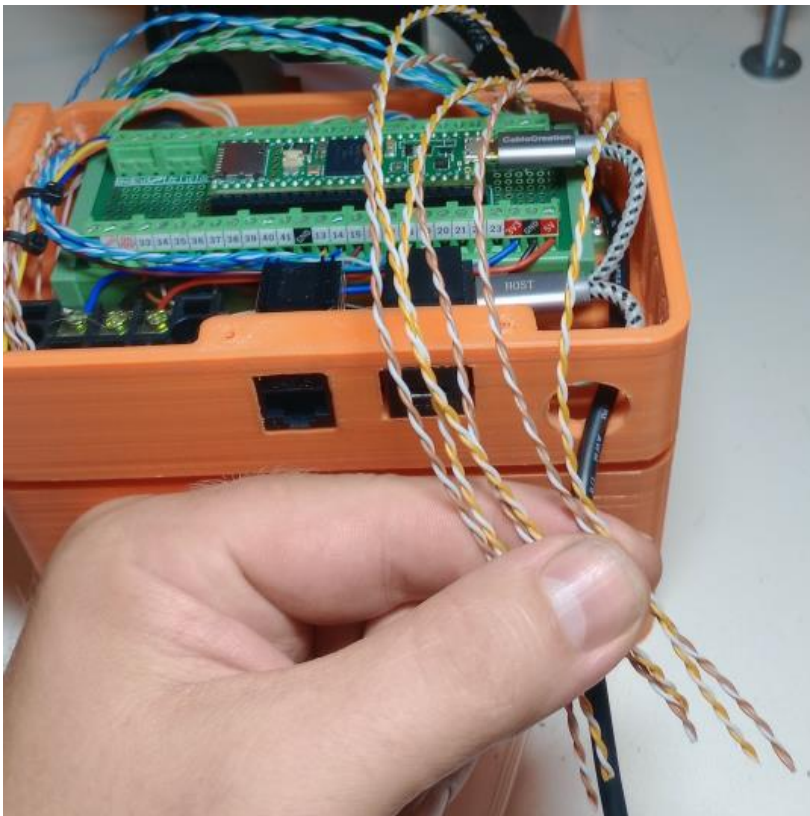

Lower the tray and then find the brown and orange pairs of wires that were labeled for J4, J5 and J6, separate these from the blue and green pairs but make sure the blue and green pairs remain labeled.

The brown wires supply 5v to the encoders and the orange wires supply 3.3v to the limit switches – its not important that these wires remain labeled.

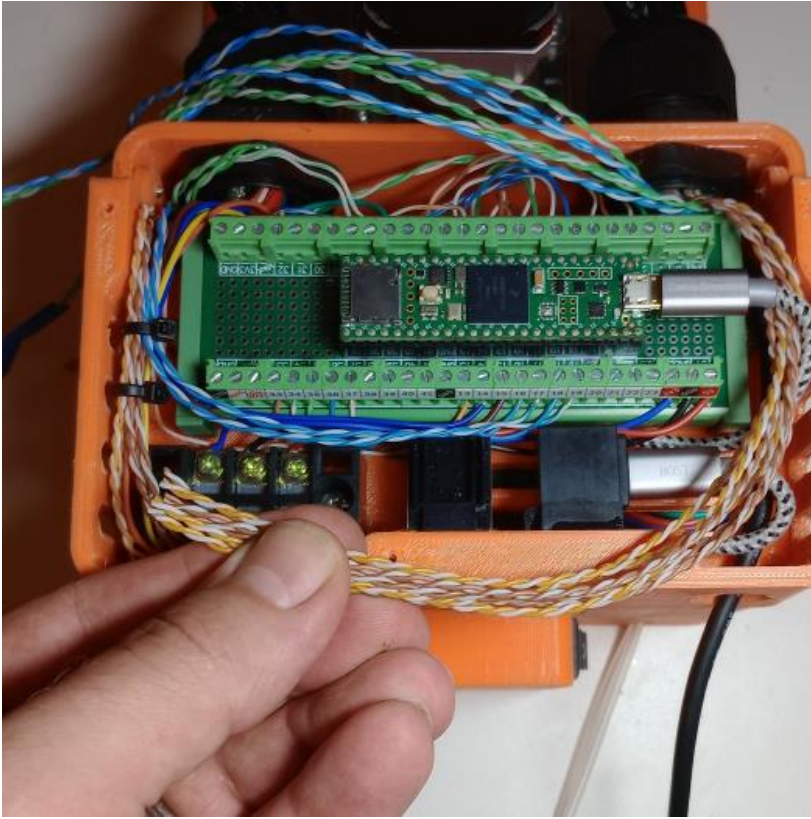

Trim the brown and orange wire pairs so that they will reach the 3 terminal block as shown.

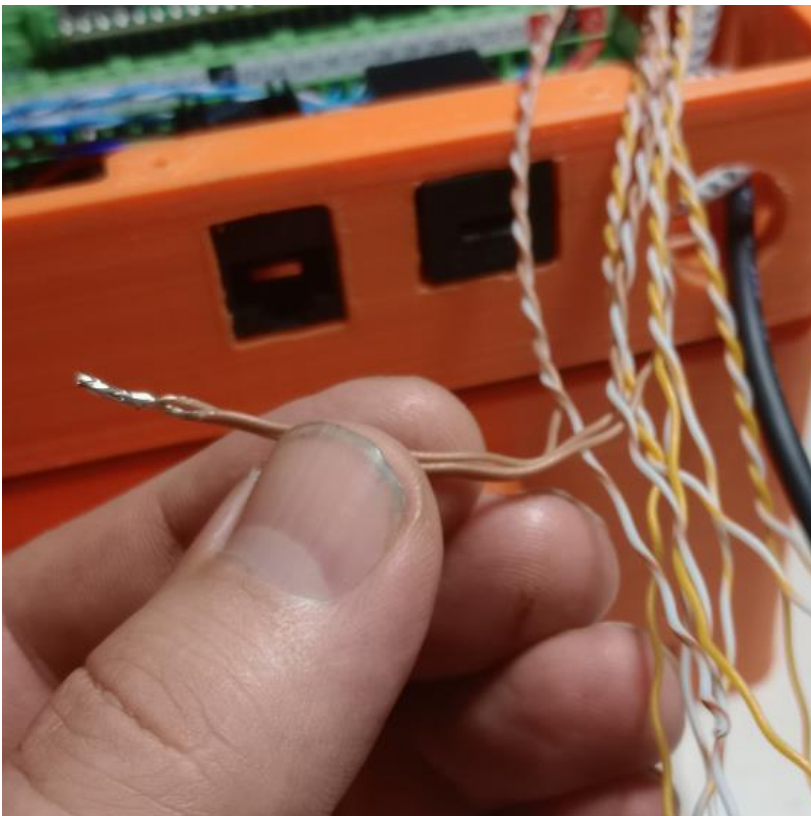

Solder the J4, J5 and J6 brown wires together as shown.

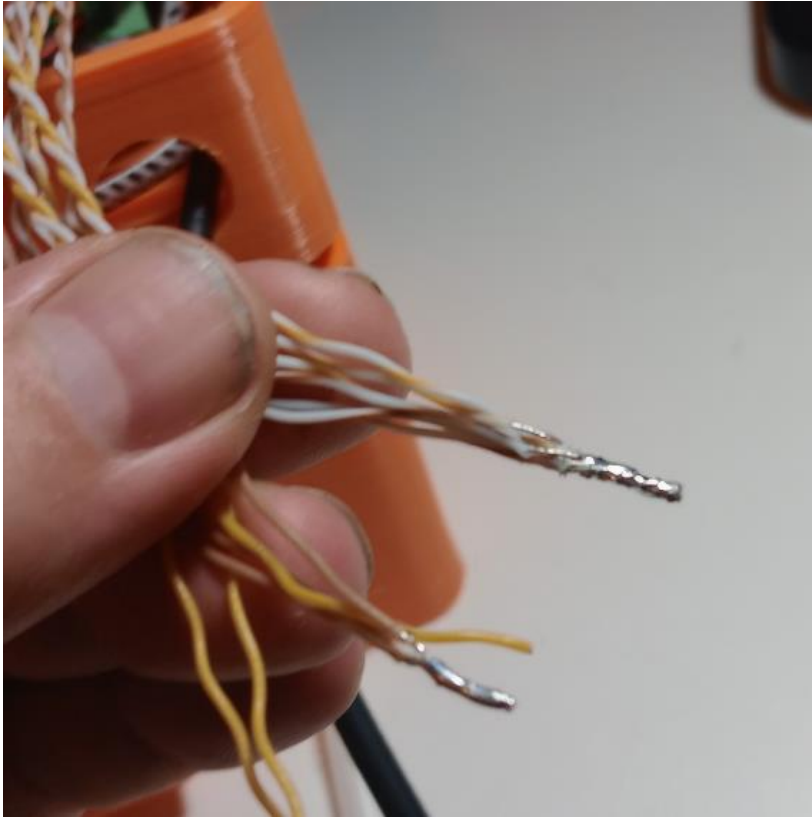

Solder the J4, J5 and J6 brown & orange stripe wires together as shown.

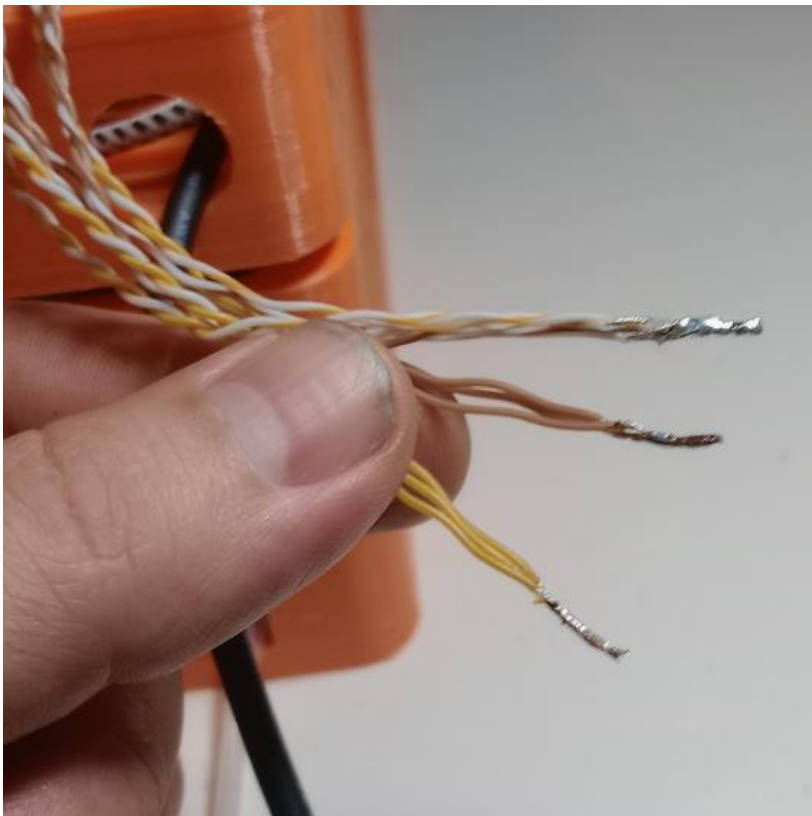

Solder the J4, J5 and J6 orange wires together as shown.

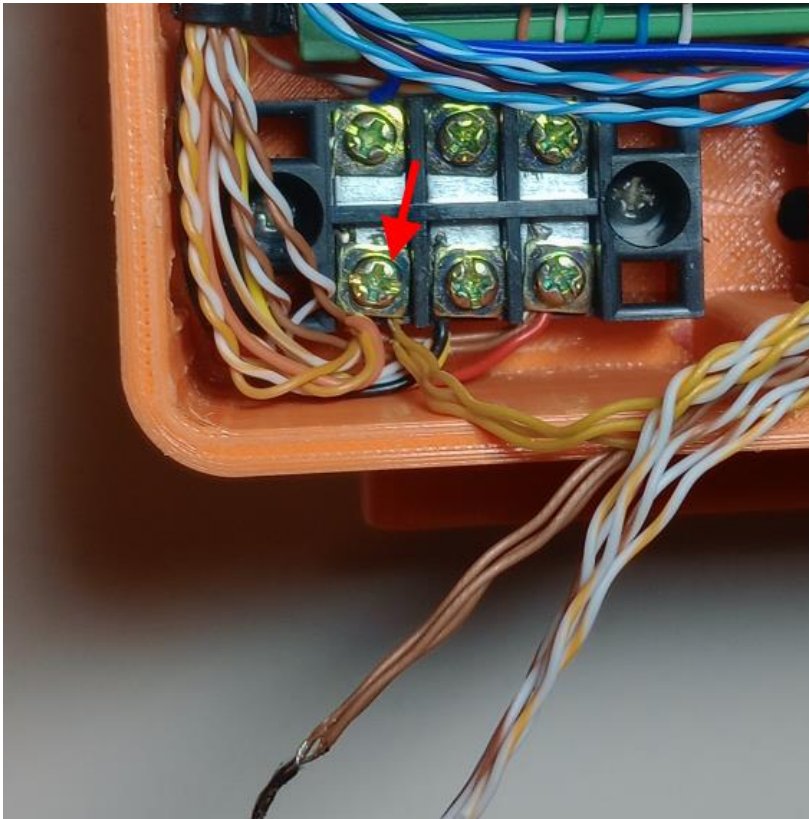

Secure the orange wires to the left terminal (along with the previously connected J1, J2, J3 wires) as shown.

NOTE: It can be difficult to get the wire groups maneuvered into position under the terminal lug – It helps to use a magnetic screw driver for the lug screw and small pair of needle nose pliers to maneuver the wires.

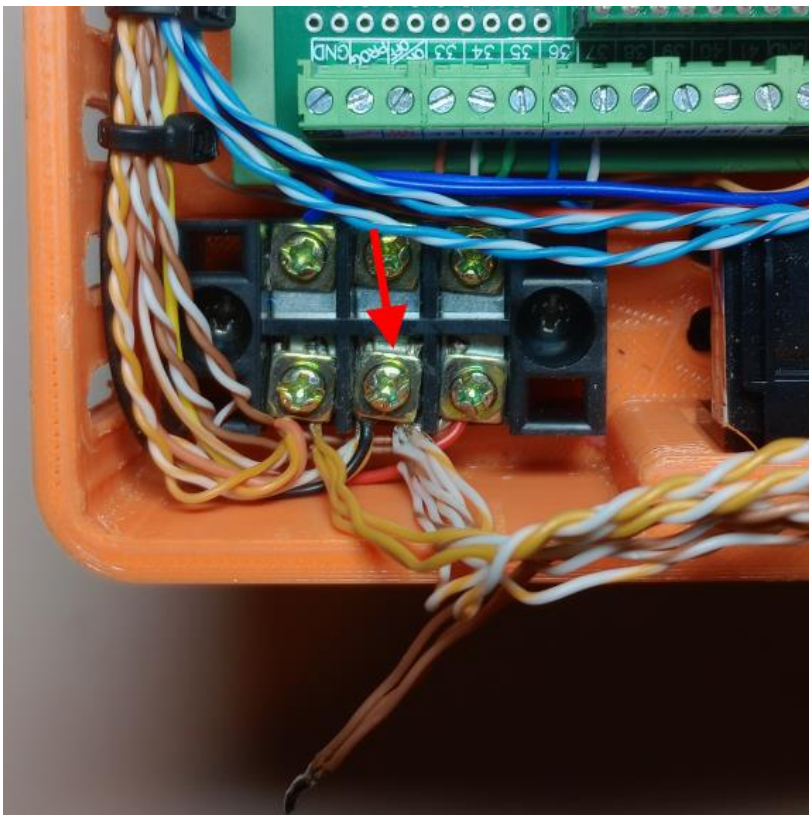

Secure the orange/brown stripe wires to the center terminal (along with the previously connected J1, J2, J3 wires) as shown.

NOTE: It can be difficult to get the wire groups maneuvered into position under the terminal lug – It helps to use a magnetic screw driver for the lug screw and small pair of needle nose pliers to maneuver the wires.

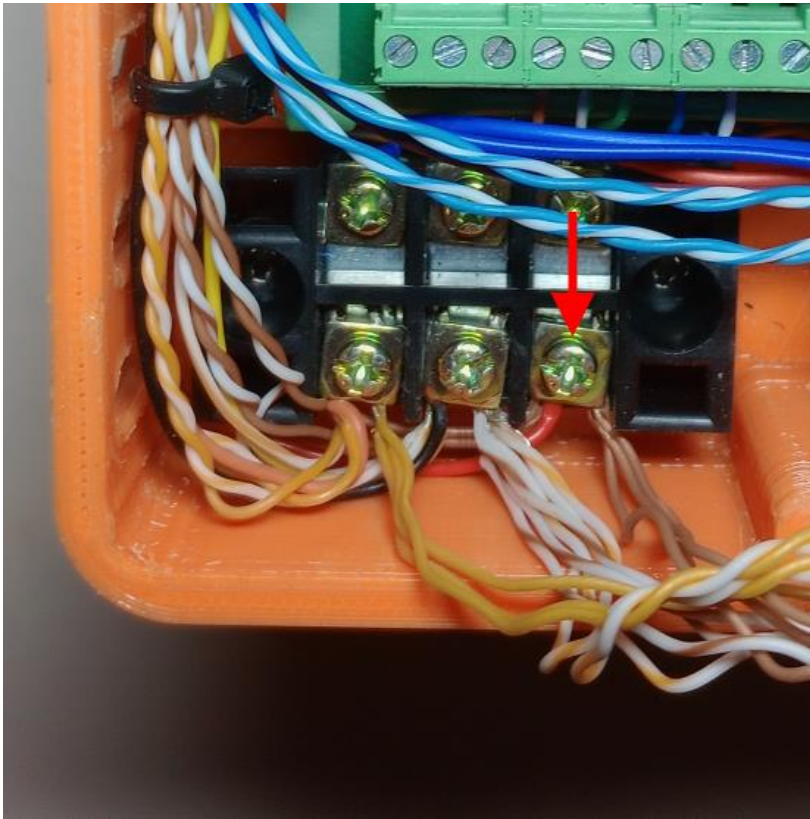

Secure the brown wires to the right terminal (along with the previously connected J1, J2, J3 wires) as shown.

NOTE: It can be difficult to get the wire groups maneuvered into position under the terminal lug – It helps to use a magnetic screw driver for the lug screw and small pair of needle nose pliers to maneuver the wires.

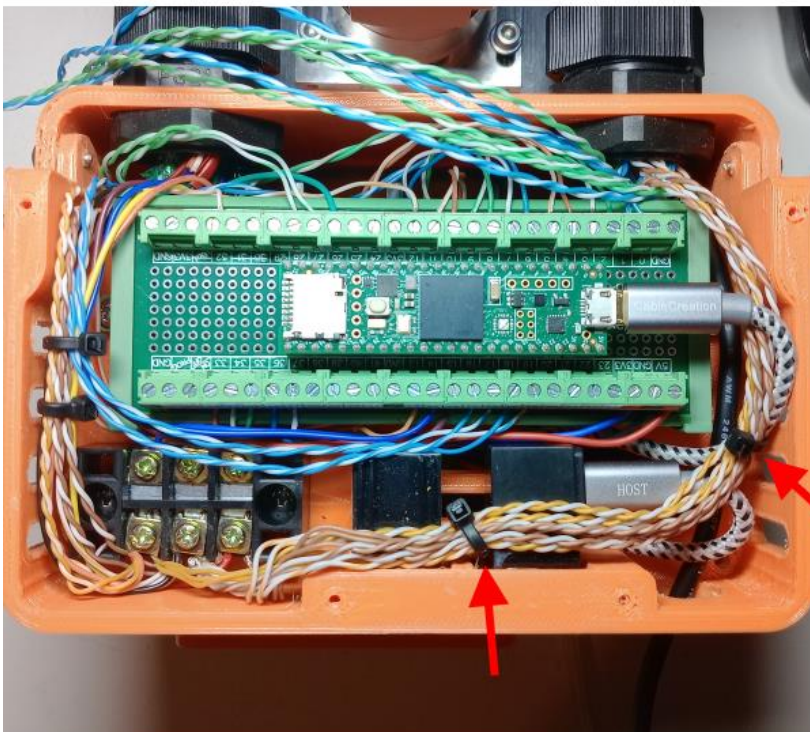

Use 2 small cable ties to bundle the orange and brown pairs as shown.



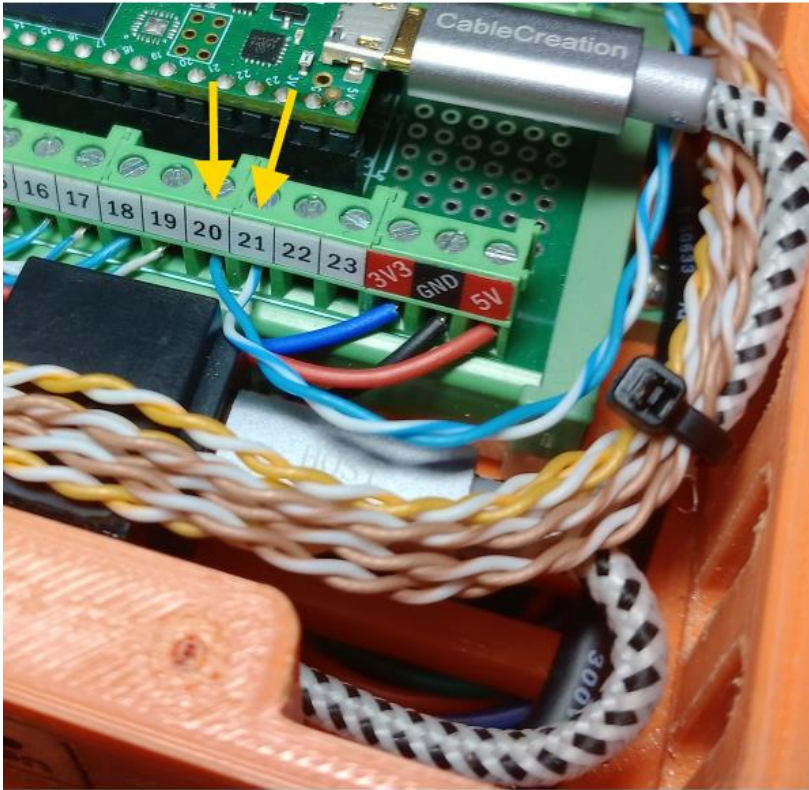

Find the blue wires from the J4 group labeled with 4 stripes.

Route and cut the blue wires to length to reach terminal 20 and 21 as shown.

Strip the end of the blue solid wire and connect to terminal 20.

Strip the end of the blue stripe wire and connect to terminal 21.

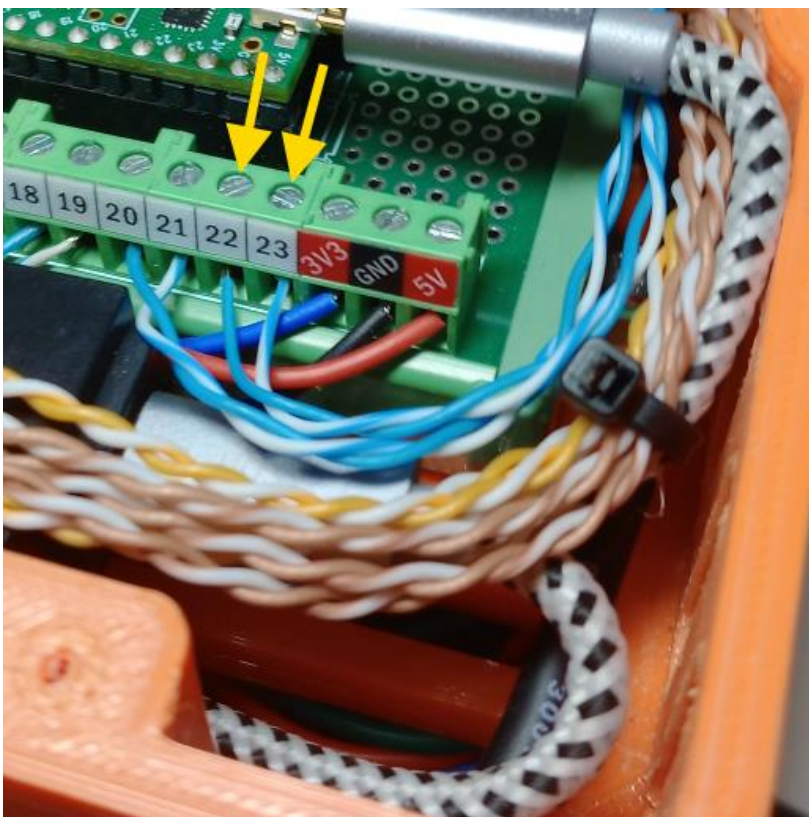

Find the blue wires from the J5 group labeled with 5 stripes.

Route and cut the blue wires to length to reach terminal 22 and 23 as shown.

Strip the end of the blue solid wire and connect to terminal 22.

Strip the end of the blue stripe wire and connect to terminal 23.



Find the blue wires from the J6 group labeled with 6 stripes.

Route and cut the blue wires to length to reach terminal 24 and 25 as shown.

Strip the end of the blue solid wire and connect to terminal 24.

Strip the end of the blue stripe wire and connect to terminal 25.

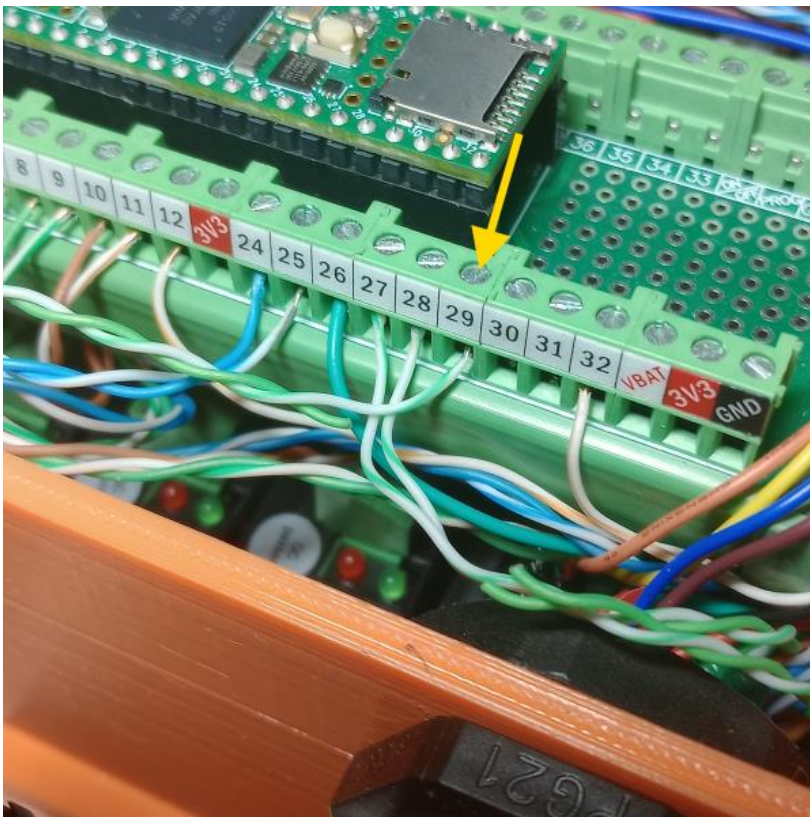

Find the green wires from the J4 group labeled with 4 stripes.

Route and cut the green wires to length to reach terminal 29 as shown.

Strip the end of the green stripe wire and connect to terminal 29.

NOTE: the solid green wire is not used and can be trimmed back and left unused.



Find the green wires from the J5 group labeled with 5 stripes.

Route and cut the green wires to length to reach terminal 30 as shown.

Strip the end of the green stripe wire and connect to terminal 30.

NOTE: the solid green wire is not used and can be trimmed back and left unused.



Find the green wires from the J6 group labeled with 6 stripes.

Route and cut the green wires to length to reach terminal 31 as shown.

Strip the end of the green stripe wire and connect to terminal 31.

NOTE: the solid green wire is not used and can be trimmed back and left unused.

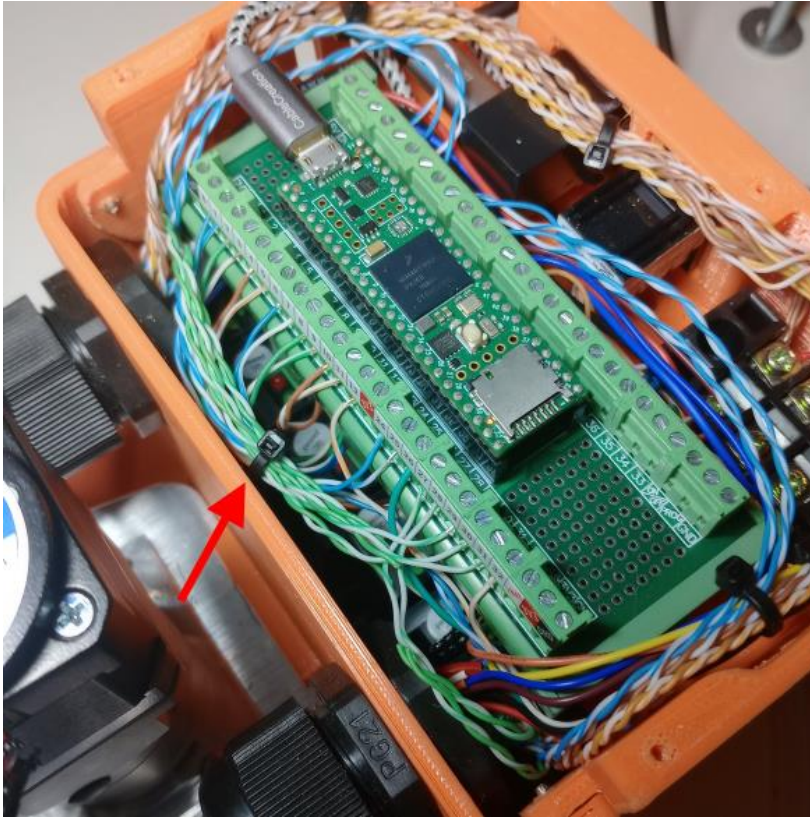

Use a small cable tie to bundle the green and blue strip wires as shown.

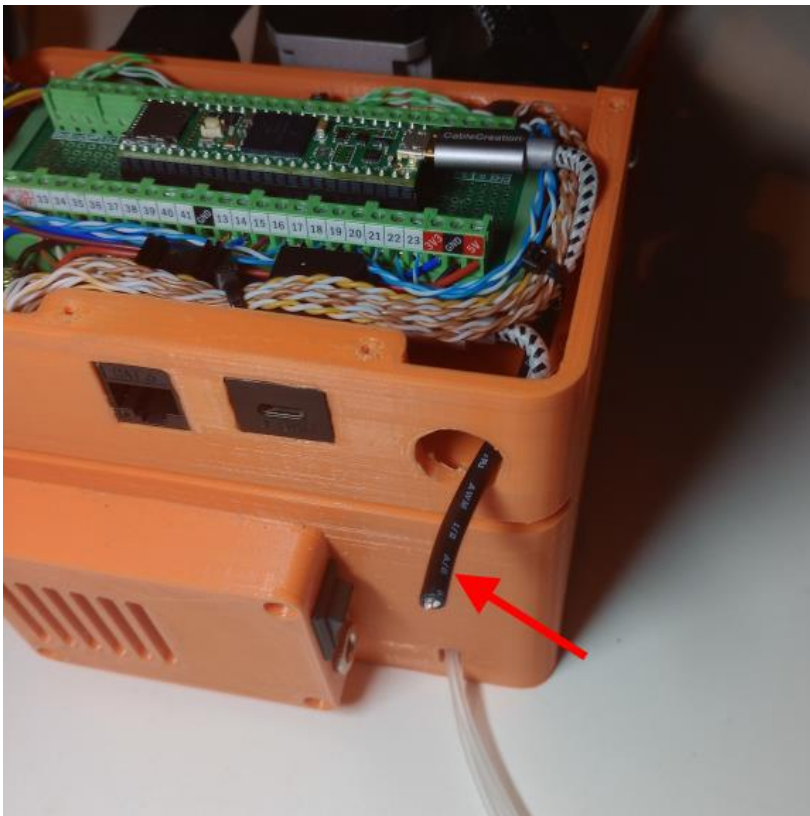

Trim the 3 conductor gripper cable so that it extends from the enclosure tray 3cm.

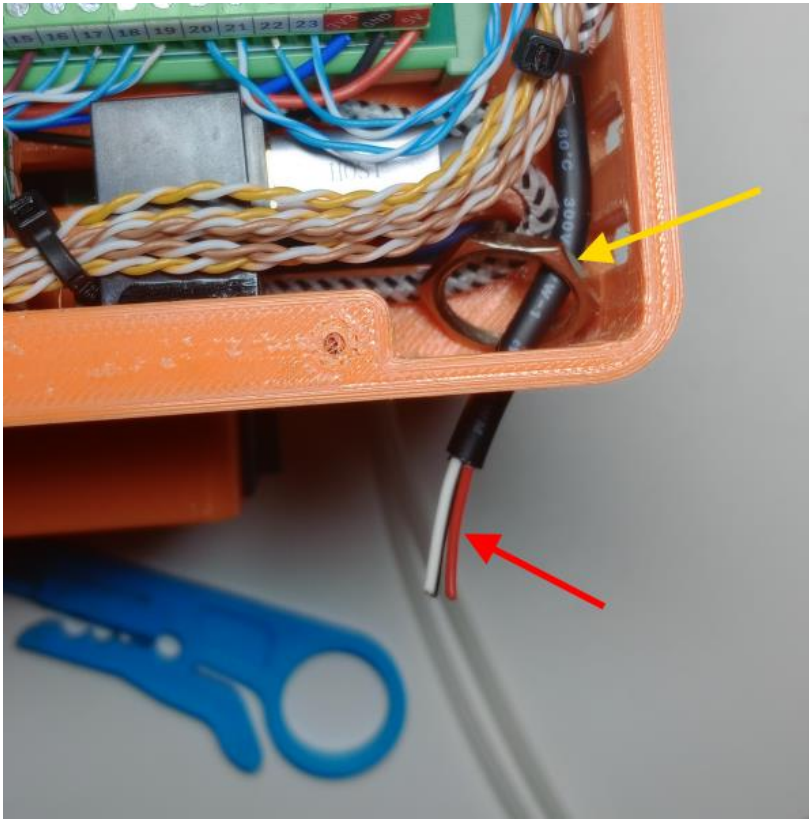

Pull cable back through hole and install nut from GX16-4 plug (yellow arrow) and then feed cable back through hole.

Next, use cable stripping tool to remove 2cm of the cable jacket as shown (red arrow).



Solder the gripper cable to the GX16-4 male connector as follows:

- **BLACK** to terminal 1
- **RED** to terminal 2
- **WHITE** to terminal 3





Insert connector into enclosure and then tighten nut from the backside.

NOTE: the nut can be difficult to spin onto connector, using a small pair of needle nose pliers and a small screw driver to manipulate the nut can be helpful.

**THE NEXT STEP IS TO SET ALL OF THE
DRIVER DIP SWITCH SETTINGS, SET
EACH DRIVERS DIP SWITCHES AS SHOWN
ON THE NEXT PAGE.**



DIP SWITCH SETTING – LATEST SOFTWARE VERSION 6.1 AND NEWER

THESE SETTINGS ARE USED WITH THE LATEST SOFTWARE – IF YOU ARE RUNNING AN OLDER VERSION PRIOR TO 6.1 PLEASE REFER TO THE NEXT PAGE:

- | | | |
|-----------------------------|-----------------|----------|
| • J1 - 17HS15-1684D-EG10 | 800 micro step | 1.82 AMP |
| • J2 - 23HS22-2804D-HG50 | 800 micro step | 2.29 AMP |
| • J3 - 17HS15-1684D-EG50 | 800 micro step | 1.82 AMP |
| • J4 - 11HS20-0674D-EGS16 | 800 micro step | 0.50 AMP |
| • J5 - 17LS19-1684E-200G-C1 | 1600 micro step | 1.56 AMP |
| • J6 - 14HS13-0804D-PG19 | 800 micro step | 0.92 AMP |

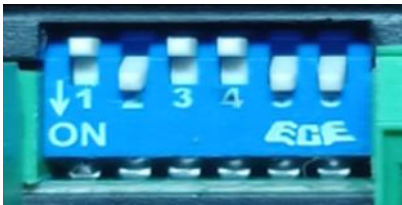

J1 – (DM332T):

SW1 = OFF SW2 = ON SW3 = OFF SW4 = OFF
SW5 = ON SW6 = ON

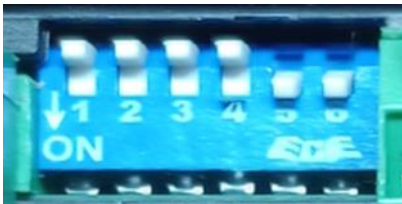

J2 – (DM332T):

SW1 = OFF SW2 = OFF SW3 = OFF SW4 = OFF
SW5 = ON SW6 = ON



J3 – (DM332T):

SW1 = OFF SW2 = ON SW3 = OFF SW4 = OFF
SW5 = ON SW6 = ON

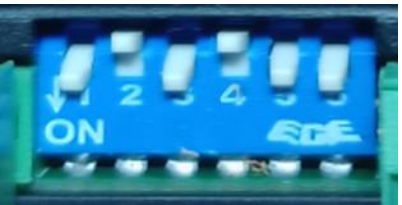

J4 – (DM320T):

SW1 = ON SW2 = OFF SW3 = ON SW4 = OFF
SW5 = ON SW6 = ON

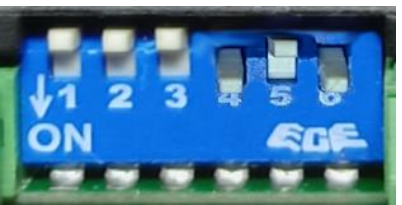

J5 – (DM320T):

SW1 = OFF SW2 = OFF SW3 = OFF SW4 = ON
SW5 = OFF SW6 = ON

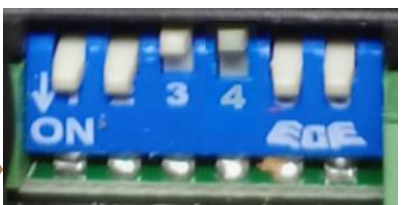

J6 – (DM320T):

SW1 = ON SW2 = ON SW3 = OFF SW4 = OFF
SW5 = ON SW6 = ON

DIP SWITCH SETTING – SOFTWARE VERSION 6.0 AND PREVIOUS

THESE SETTINGS ARE USED FOR THE FOLLOWING SERIES MOTORS:

- | | | |
|-----------------------------|----------------|----------|
| • J1 - 17HS15-1684D-EG10 | 400 micro step | 1.82 AMP |
| • J2 - 23HS22-2804D-HG50 | 400 micro step | 2.29 AMP |
| • J3 - 17HS15-1684D-EG50 | 400 micro step | 1.82 AMP |
| • J4 - 11HS20-0674D-EGS16 | 400 micro step | 0.50 AMP |
| • J5 - 17LS19-1684E-200G-C1 | 800 micro step | 1.56 AMP |
| • J6 - 14HS13-0804D-PG19 | 400 micro step | 0.92 AMP |

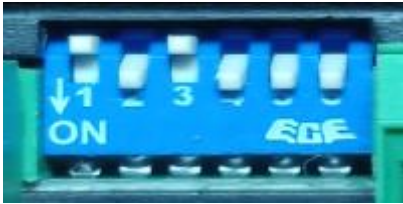

J1 – (DM332T):

SW1 = OFF SW2 = ON SW3 = OFF SW4 = ON
SW5 = ON SW6 = ON



J2 – (DM332T):

SW1 = OFF SW2 = OFF SW3 = OFF SW4 = ON
SW5 = ON SW6 = ON



J3 – (DM332T):

SW1 = OFF SW2 = ON SW3 = OFF SW4 = ON
SW5 = ON SW6 = ON



J4 – (DM320T):

SW1 = ON SW2 = OFF SW3 = ON SW4 = ON
SW5 = ON SW6 = ON

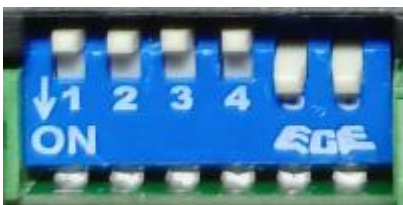

J5 – (DM320T):

SW1 = OFF SW2 = OFF SW3 = OFF SW4 = OFF
SW5 = ON SW6 = ON

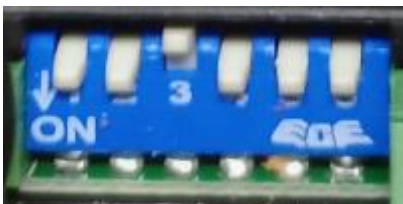

J6 – (DM320T):

SW1 = ON SW2 = ON SW3 = OFF SW4 = ON
SW5 = ON SW6 = ON

NOTE: If using a 7th joint travel track (nema 17) use the same setting as J1.

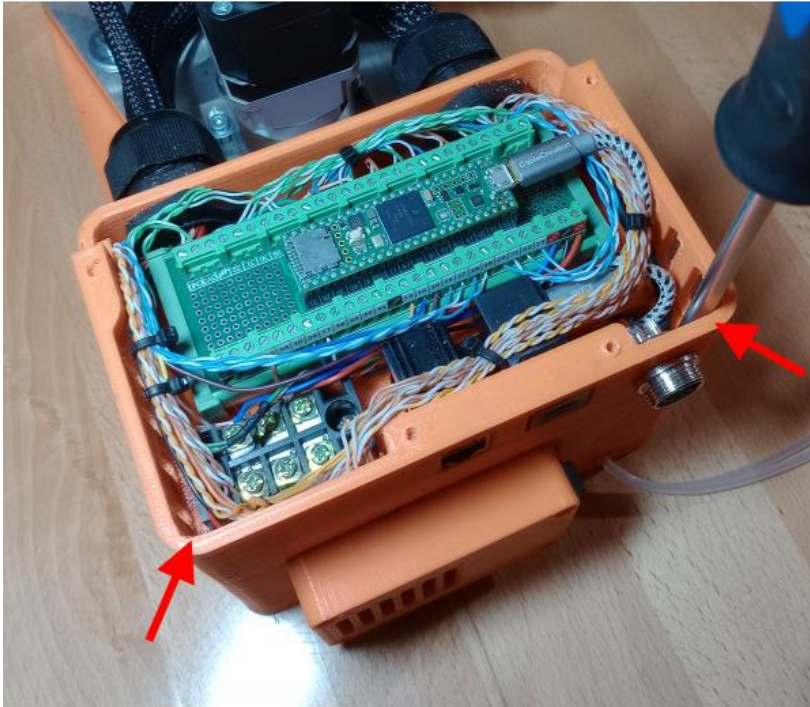

Install (2) #6 thread form screws in the tray corners shown to hold the tray down to the enclosure base.

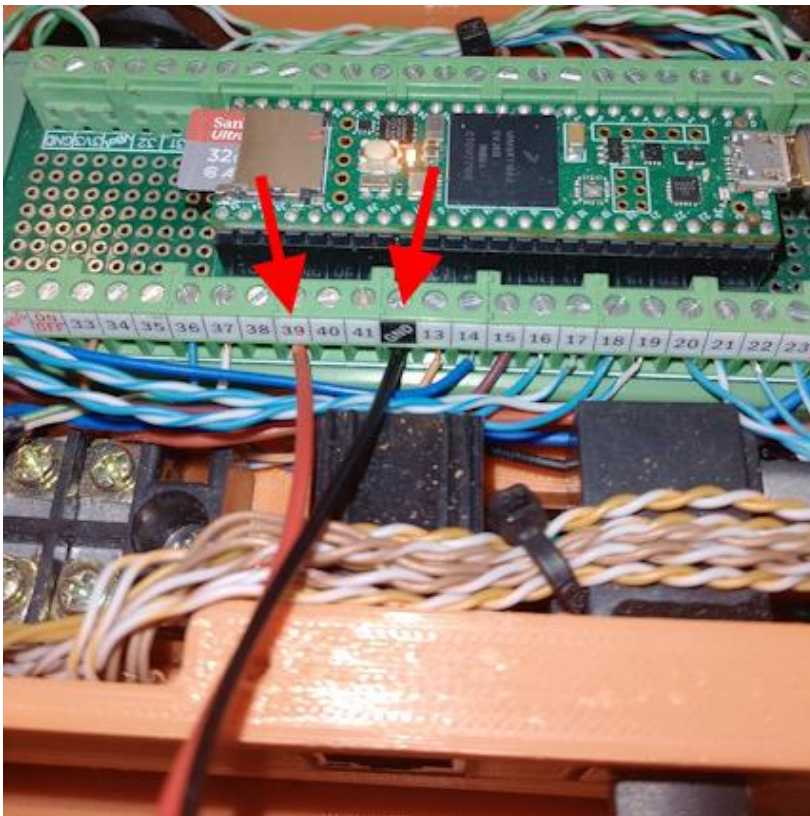

Secure PBS-110 push button lead wires to the terminal breakout board as shown:

Red wire – terminal 39.

Black wire – terminal GND.



Install PBS-110 push button switch in enclosure lid as shown.



Install enclosure lid and secure with (4) #6 thread form screws.

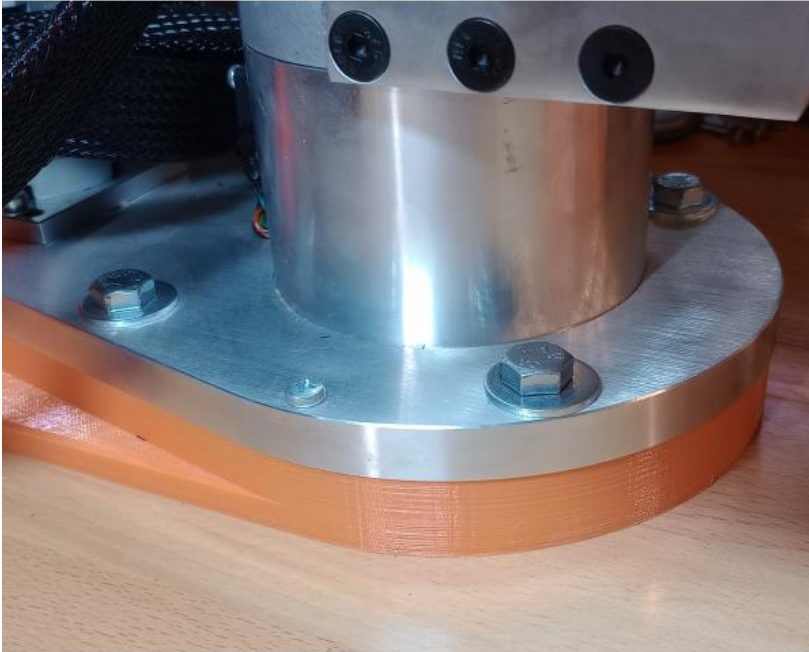

Secure robot to work surface using M8 or equivalent fasters with washers. Depending on your work surface these may be threaded hex or cap head screws or lag screws.

**THIS CONCLUDES THE ROBOT ASSEMBLY.
PLEASE REVIEW THE CHAPTER ON ROBOT
STARTUP AS WELL AS THE TUTORIAL VIDEOS
ON THE ANNIN ROBOTICS WEBSITE
TUTORIALS PAGE.**



CHAPTER 3

PLC MODBUS OPTION

The robot can communicate with PLC devices over Modbus RS-485. This is the Modbus communication protocol using the RS-485 electrical standard which allows the robot to communicate with multiple devices.



Modbus Option Bill of Materials



J1 Base Enclosure Lid - Modbus Option

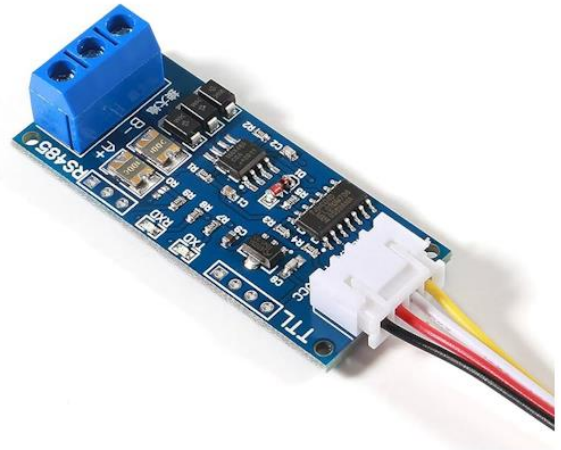

RS-485 TTL Adapter Module



M 1.6 x 4 mm screws

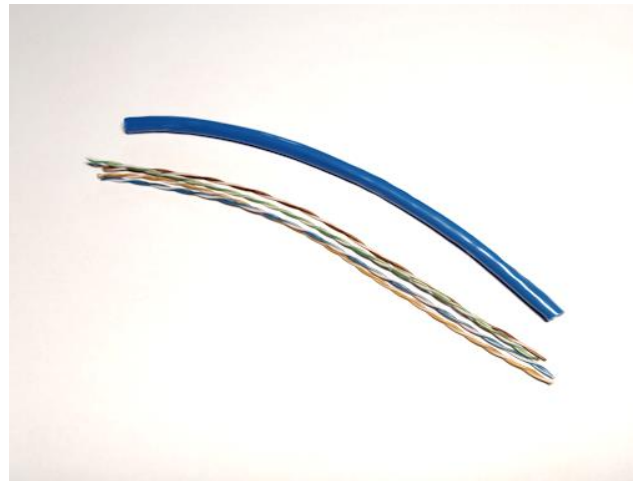

CAT5 wires – 15cm Long





RS-485 Keystone Jack



Modbus Option Assembly

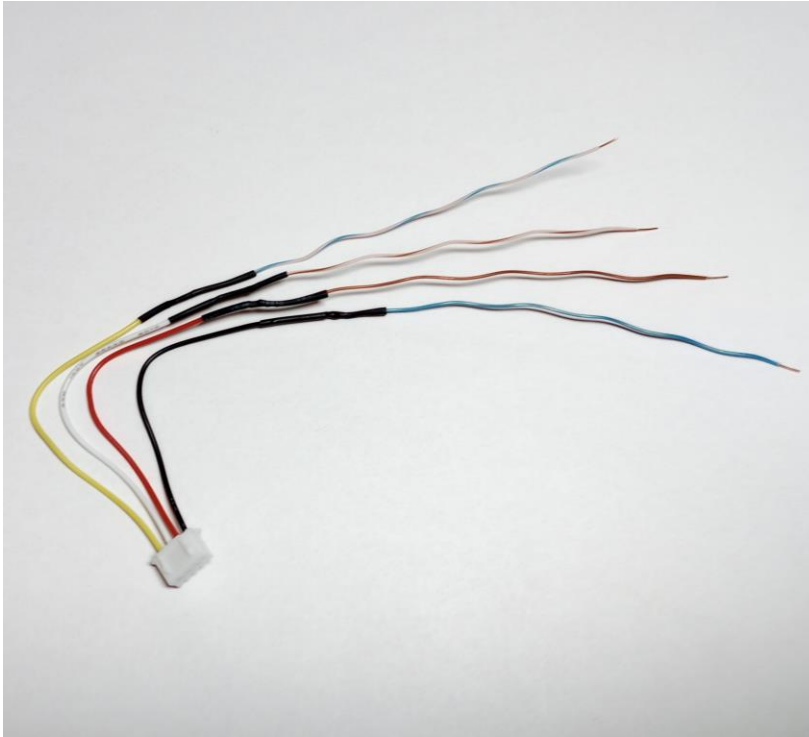

Cut (blue/white) and (brown/white) twisted pairs down to a length of 10cm and then solder and heat shrink to extend the RS-485 module plug wires as follows:

- Solder TTL black wire to the blue wire
- Solder the TTL yellow wire to the blue/stripe wire
- Solder the TTL Red wire to the brown wire
- Solder the TTL white wire to the brown stripe wire

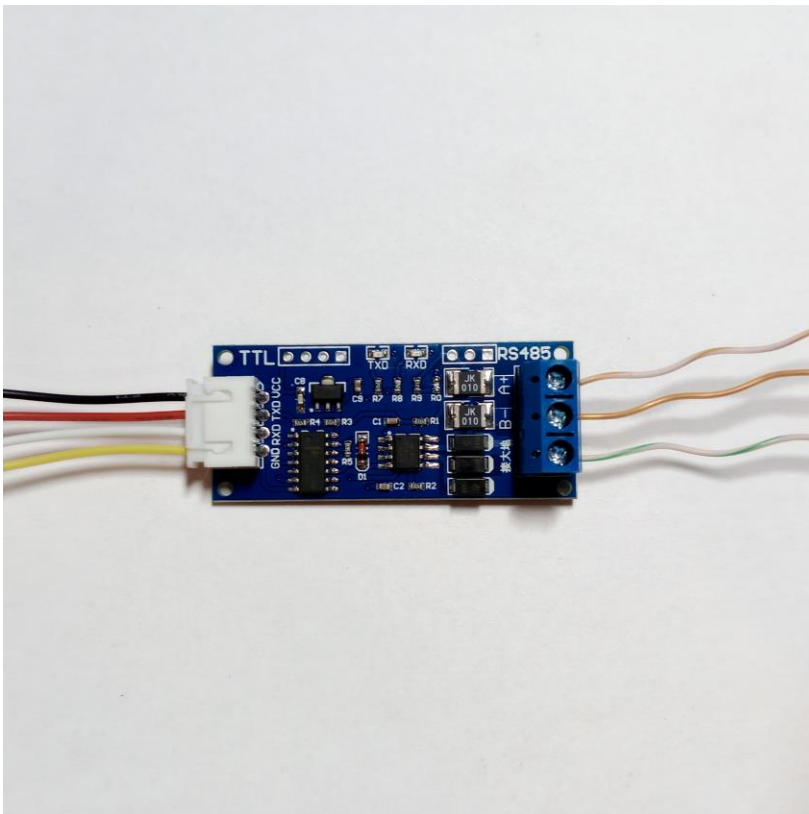

Insert the plug into the TTL board as shown on left side of board.

Strip wire ends and connect the 10cm long CAT5 wires to the terminals on right side of board as follows:

- Orange/Stripe wire to the “A+” terminal
- Orange wire to the “B-” terminal.
- Green/stripe wire to the GND terminal

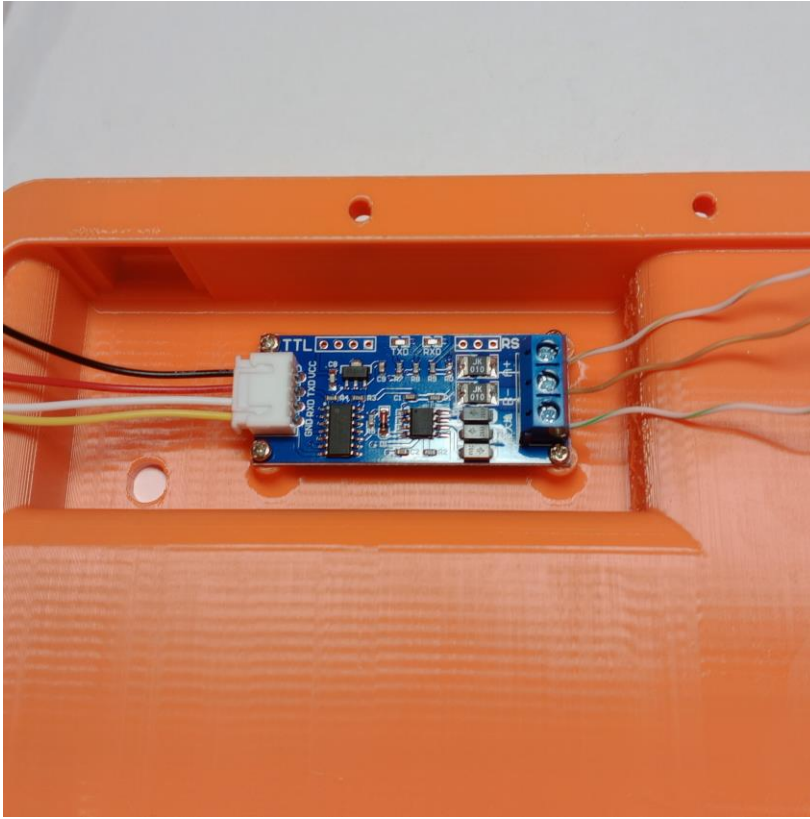

Install the RS-485 TTL board into the bottom of the “J1 Base Enclosure Lid – Modbus Option” as shown and secure with (4) M1.6x4 screws.

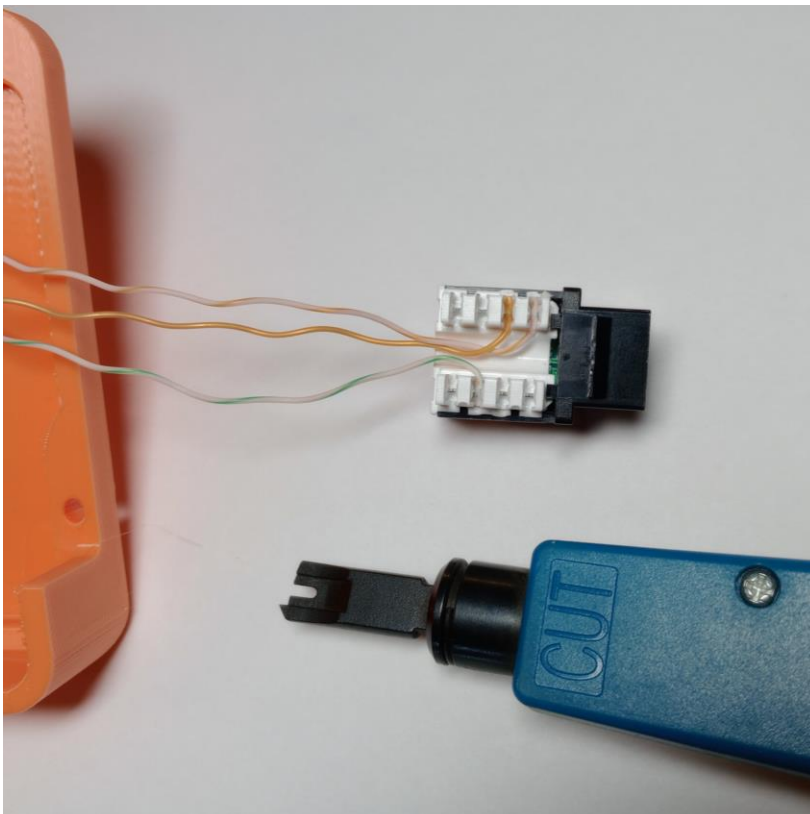

Use a keystone punchdown tool to insert the RS-485 TTL output wires into the RJ45 keystone jack as follows:

- Orange/Stripe wire to terminal 1B
- Orange wire to terminal 2B
- Green/Stripe wire to terminal 3B



Install the keystone jack into the lid enclosure as shown.



Install the PBS-110 push button switch into the enclosure lid hole as shown and secure with included nut.

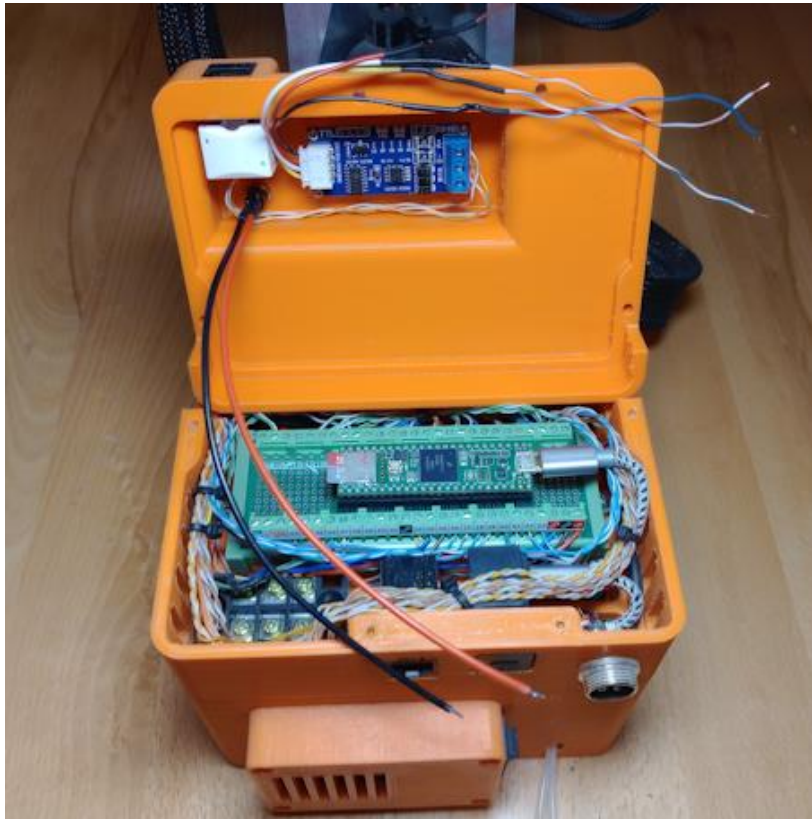

Position lid as shown to prepare to connect wires to the teensy control board.



Strip wire ends and secure the pushbutton black wire and the TTL board ground wire (blue/stripe) to the Teensy4.1 GND terminal as shown.

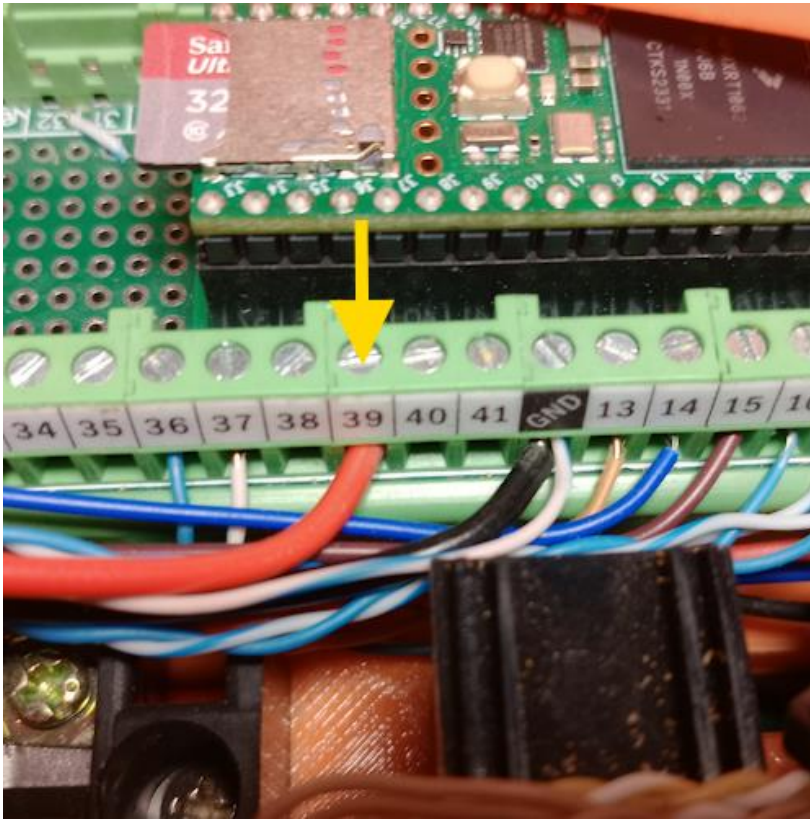

Strip wire end and connect the pushbutton red wire to terminal 39 on the Teensy4.1 board.

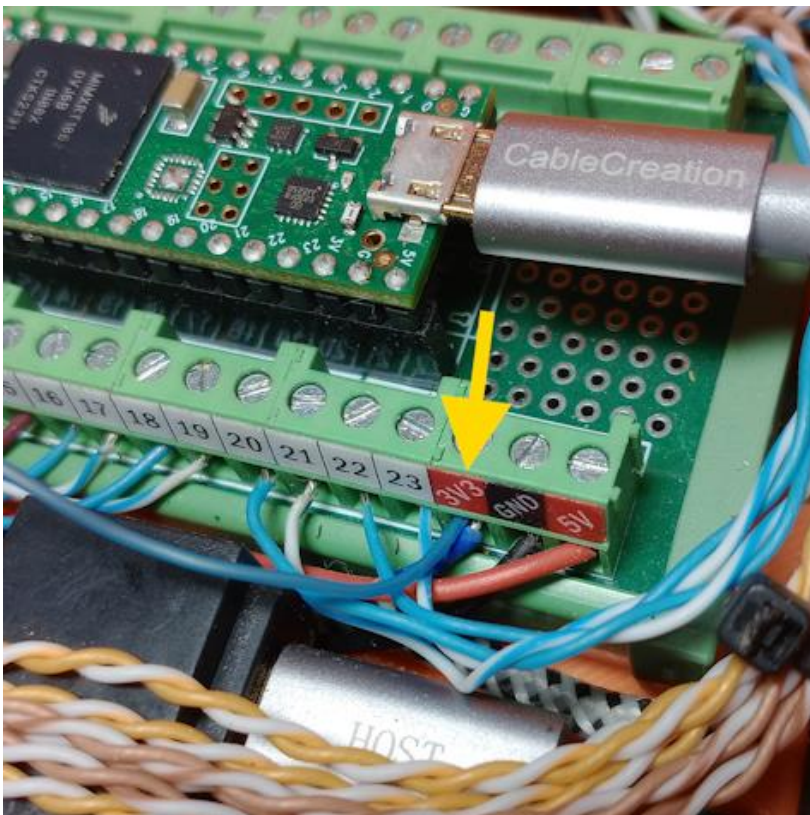

Connect the RS-485 TTL board +V (blue) wire to 3.3V terminal on the Teensy4.1 board as shown.

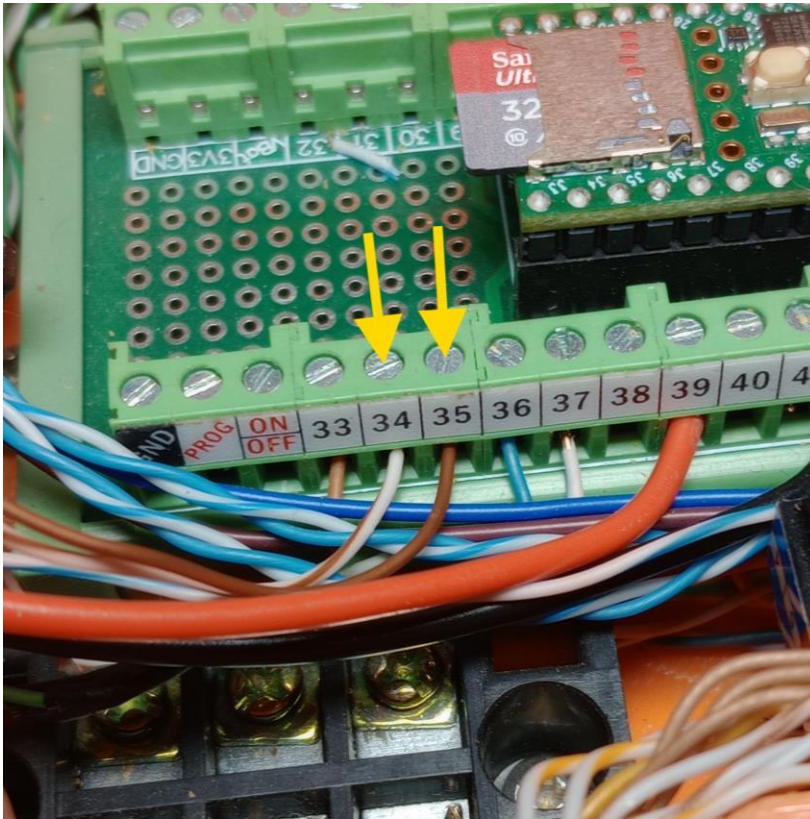

Connect the RS-485 TTL A+ and B- com wires to the Teensy4.1 board as follows:

- Brown/Stripe wire to terminal 34
- Brown wire to terminal 35



Carefully tuck wires under enclosure lid and secure as shown using (4) thread form screws as shown.

DIRECT LOGIC EXAMPLE

Different PLC manufacturers will have different ports, gateways or pinouts for using the Modbus protocol over the RS-485 standard. Many will be a simple 3 wire (A+,B-) with ground.

The Direct Logic PLC's are affordable options although the cable pinout for port 2 is a little less straight forward so I thought I would provide a wiring example here.

AR ROBOT TO DIRECT LOGIC PLC - MODBUS (RS485) CABLE PINOUT

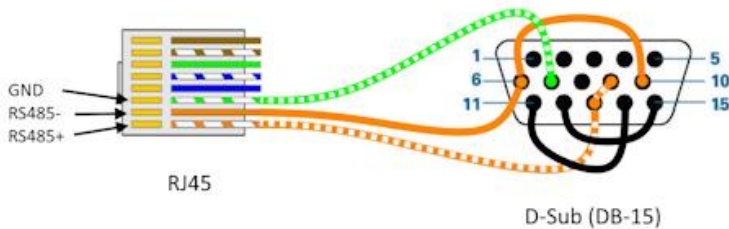

CHAPTER 4

PNEUMATIC GRIPPER

The robot can have multiple different end effectors depending on your needs. This chapter covers the installation of a pneumatic gripper.

Please also see the tutorial video on grippers and IO connections:
<https://youtu.be/76F6dS4ar8Y>



Pneumatic Gripper Bill of Materials



MHF2-8D1 pneumatic gripper.



Silicone Tubing, 2mm ID x 4mm OD High Temp Food Grade Tube Pure Silicone Hose



M3 Male Thread to 3mm 3/25" Barb



1/4"NPT Solenoid Valve 24V Single Coil Pilot-Operated Electric 2 Position 5 Way





VALVE FITTING OPTION 1

Push to Connect Fittings 4mm Tube OD
x 1/4 inch NPT Thread



VALVE FITTING OPTION 2

Push to Connect Fittings 1/8" Tube OD x
1/4 inch NPT Thread



5/16" or 8mm nylon pneumatic tubing

-

This tubing is needed to connect solenoid valve
to your compressor. Available from Amazon or
multiple online suppliers



COMPRESSOR OPTION 1

2 gallon portable air compressor

-

There are numerous options – any small air
compressor with regulator can be used.





COMPRESSOR OPTION 2

An airbrush compressor in another compressor option. This option is a little lower cost and quieter although often has less available grip pressure.

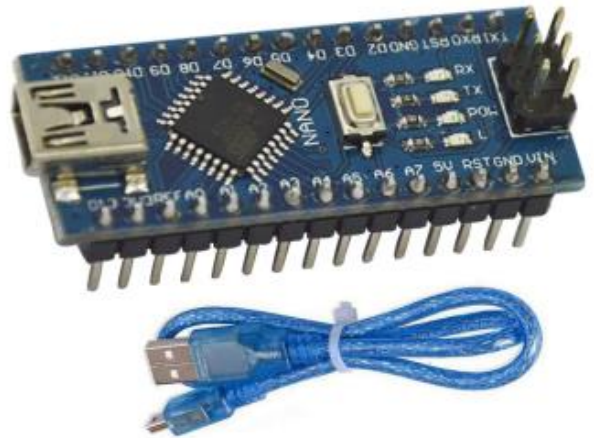

Arduino Nano control board (Arduino Mega can also be used)

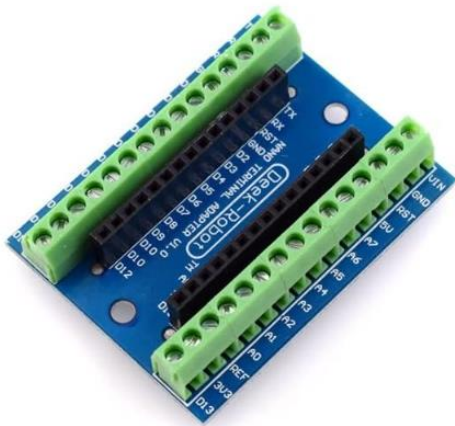

Terminal Adapter Expansion Board for Arduino Nano



5v Relay module





USB-C Keystone Jack.



5.5mm DC power jack socket.



KCD1 SPST rocker switch with lead wires.



24V 8A Power Supply Adapter

-

This power supply is available from Stepperonline (provided with the AR4 robot motors and drivers kit)





Micro USB to USB C Cable



1N4004 Rectifier Diode



20awg 2 conductor black and red wire..
63cm





Auxiliary enclosure

-

The 3D print file for this part can be found along with the robot print files on the downloads page



J1 Base enclosure fan cover

-

This is the same 3D printed part that is used on the robot base.



Gripper Jaws

-

The 3D print file for this part can be found along with the robot print files on the downloads page



Auxiliary enclosure lid

-

The 3D print file for this part can be found along with the robot print files on the downloads page.



Pneumatic Gripper Assembly

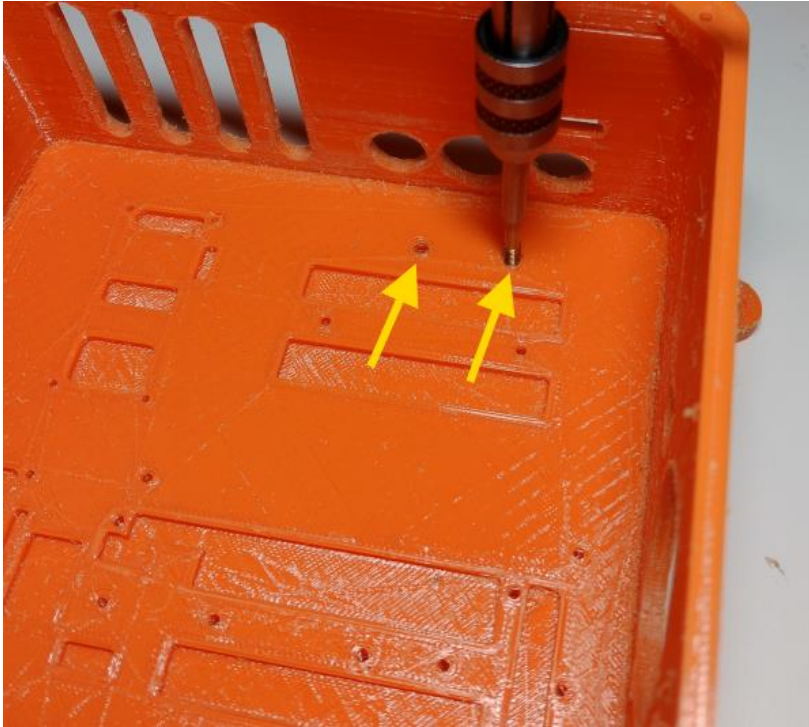

Tap the (2) auxiliary enclosure holes indicated in photo with M4 tap.

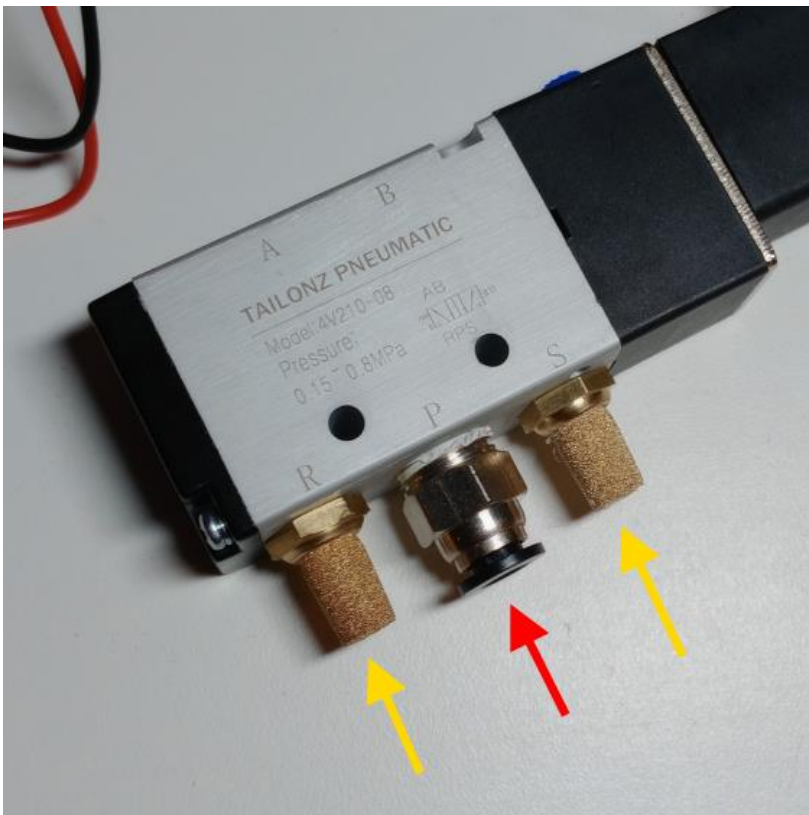

Install $\frac{1}{4}$ " or 6mm push connect pneumatic fitting in center "P" port of solenoid valve as shown (red arrow)

Install (2) pneumatic silencers in the "R"- "S" ports on either side as shown (yellow arrows)

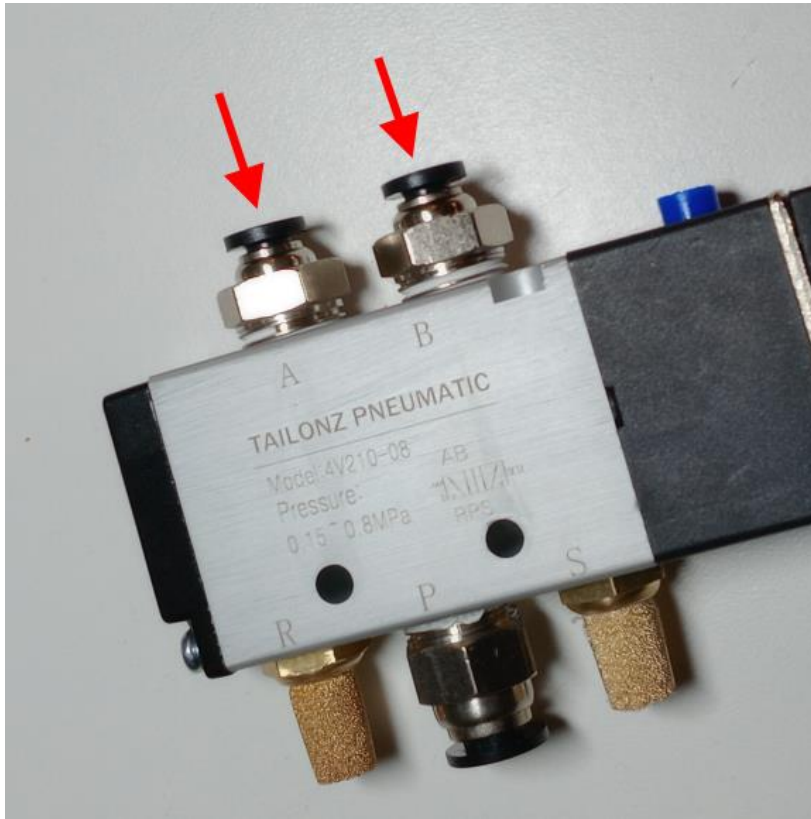

Install (2) 4mm tube push connect fittings as shown (red arrows) in the "A"- "B" ports of the solenoid valve.

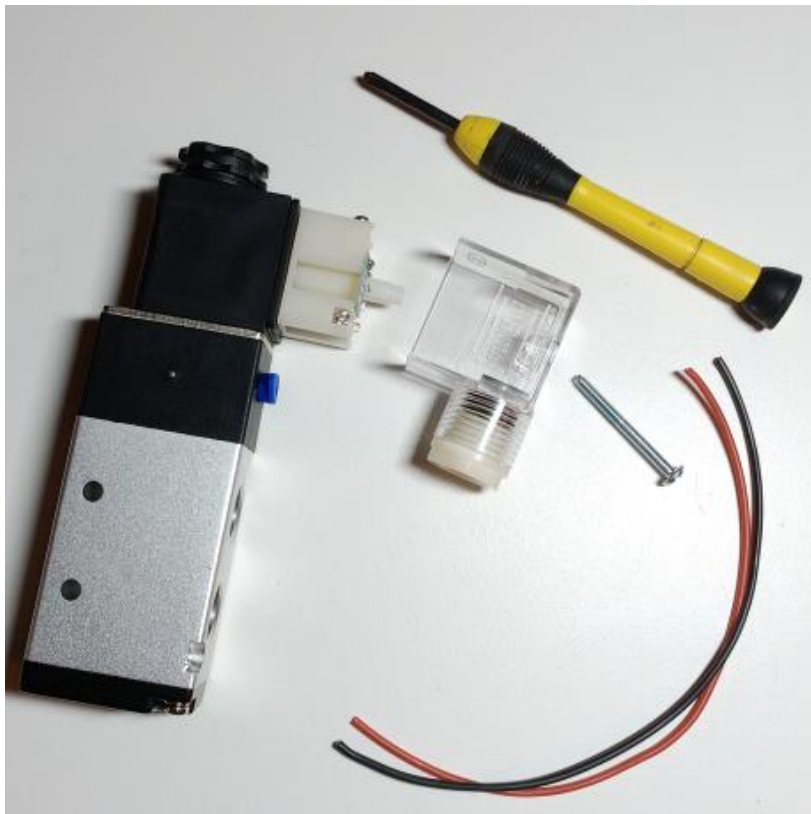

Depending on supply chain availability, your solenoid valve may not have pre-wired pigtail. In this case cut lengths of red / black 20awg wire to a length of 17cm. Remove the terminal cover.

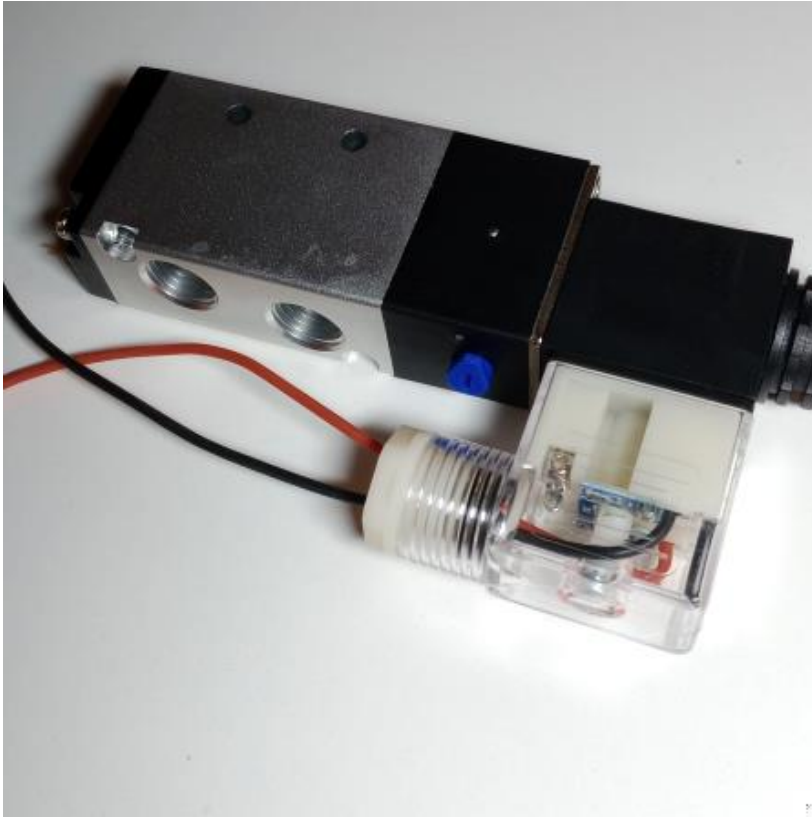

Connect the red wire to the “+” terminal and the black wire to the “-” terminal and then reinstall the terminal cover as shown.

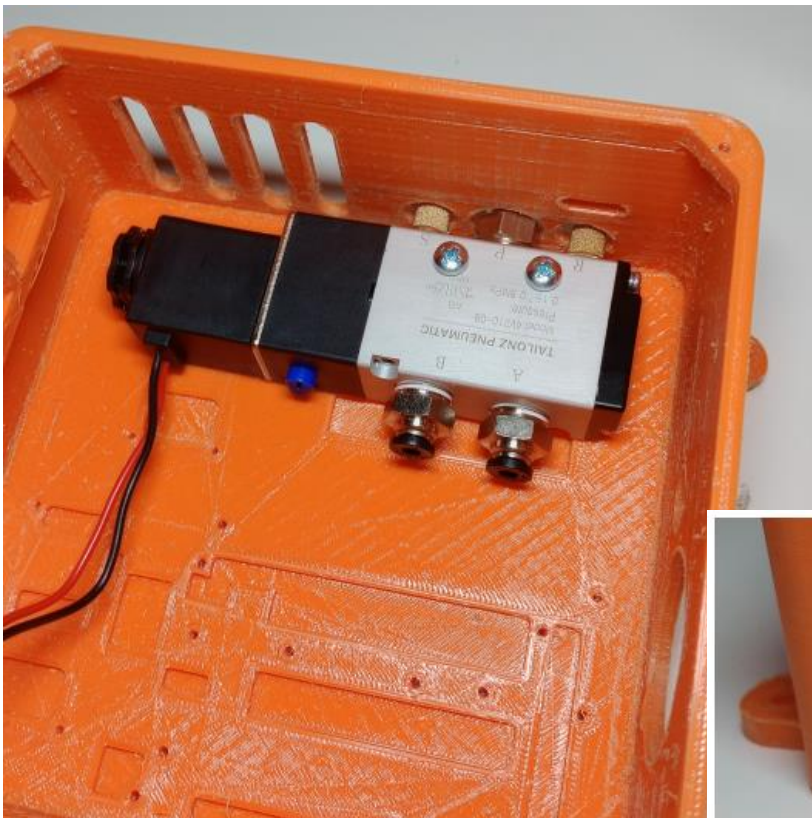

Install solenoid valve into auxiliary enclosure as shown and secure with (2) M4x30 pan head screws.

Solenoid inlet port and air silencers should protrude as shown in photo below.





Cut 25cm lengths of the 20awg 2 conductor black and red wire.

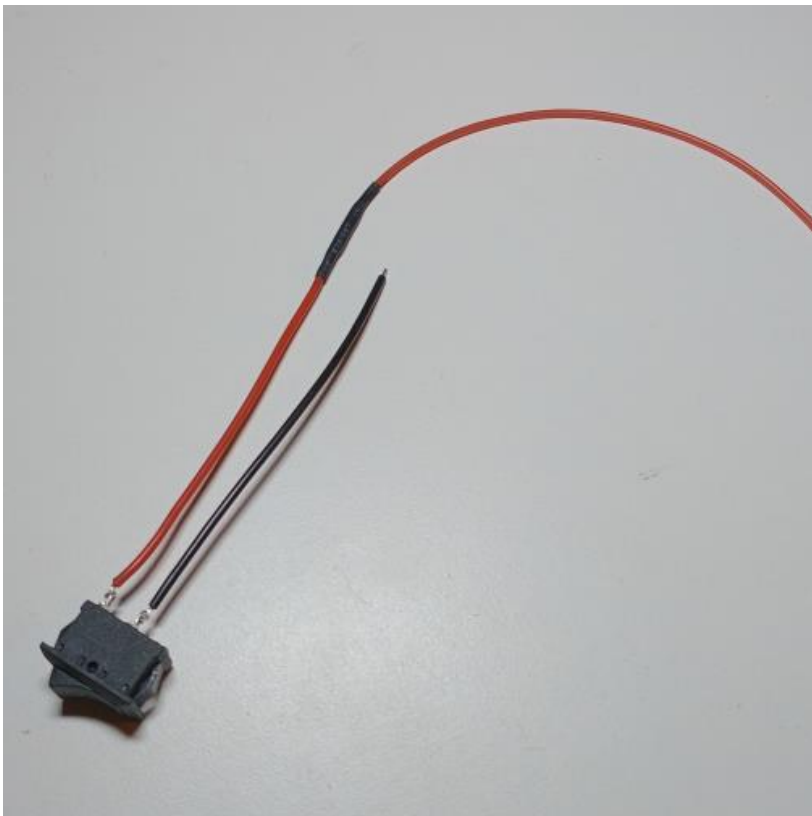

Solder and heat shrink 25cm red wire to extend the rocker switch red wire so that the total length of the red wire is 34cm long.

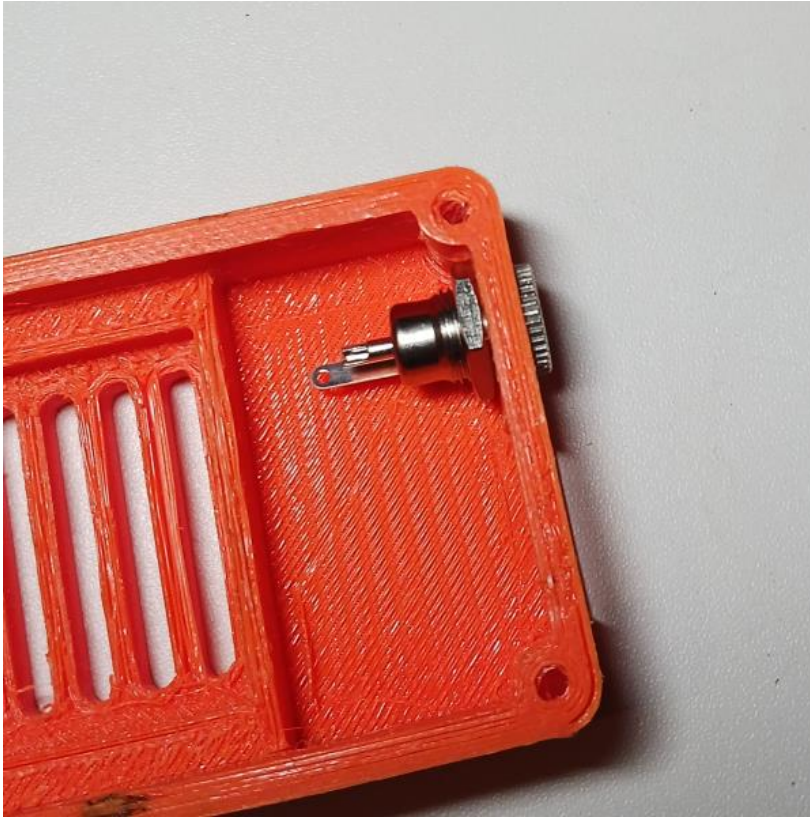

Remove all build structure from 3D printed Base Enclosure Fan Cover then install the 5.5mm power jack as shown.

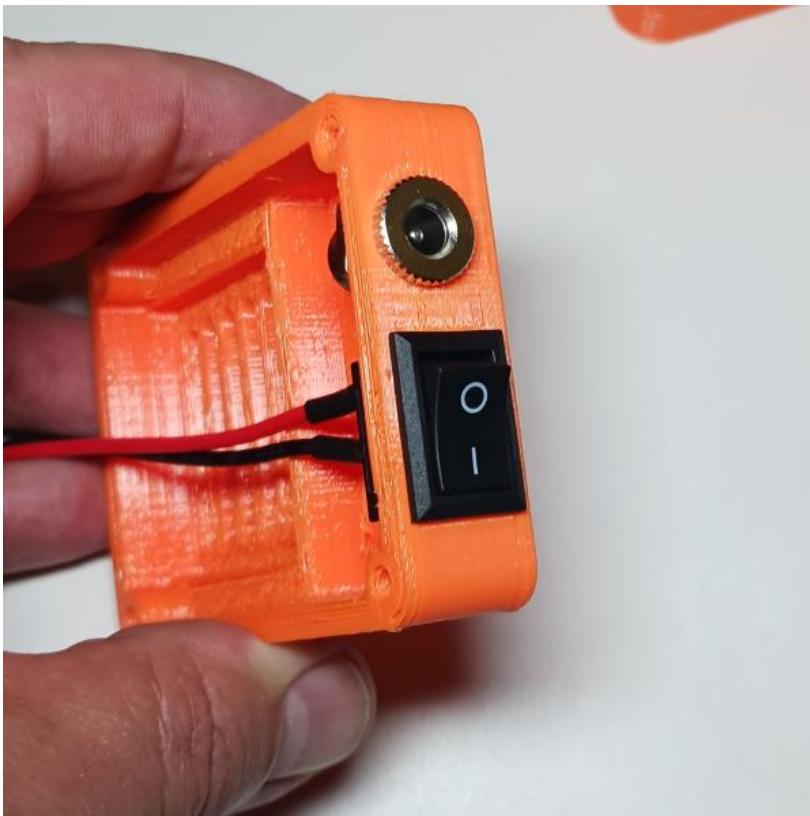

Install rocker switch as shown. Rocker switch will snap into position.

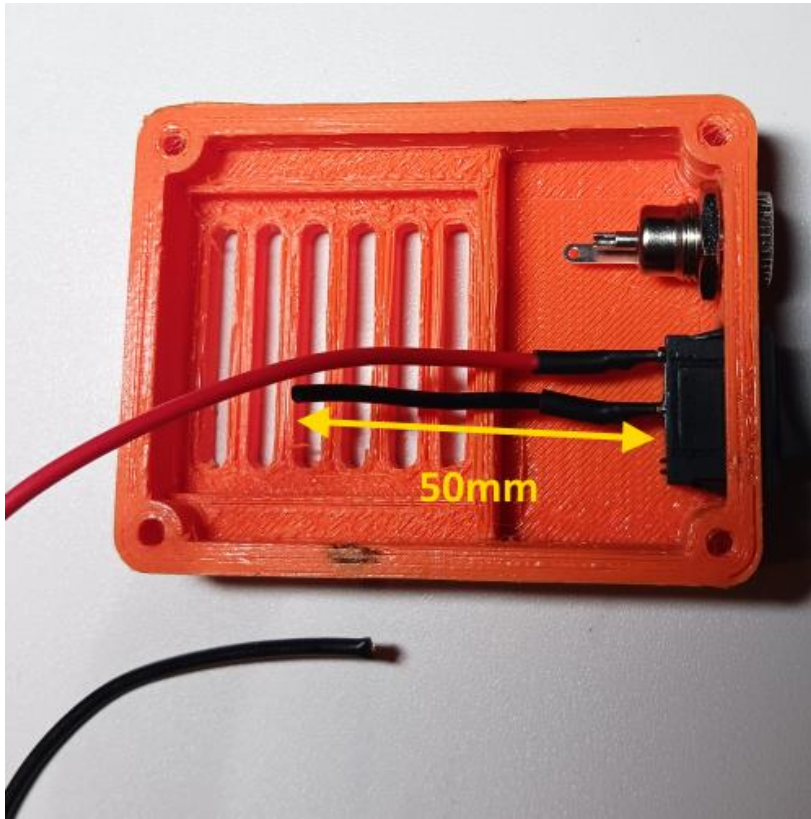

Cut the rocker switch black wire as shown leaving 50mm of wire extended from the rocker switch.



Strip 3mm of sheathing from the end of the black 25cm long wire from step 2 and then solder the wire to the 5.5mm power sockets ground connection tab as shown.

NOTE: The ground connection tab is the longer tab coming from the socket outer housing as shown.

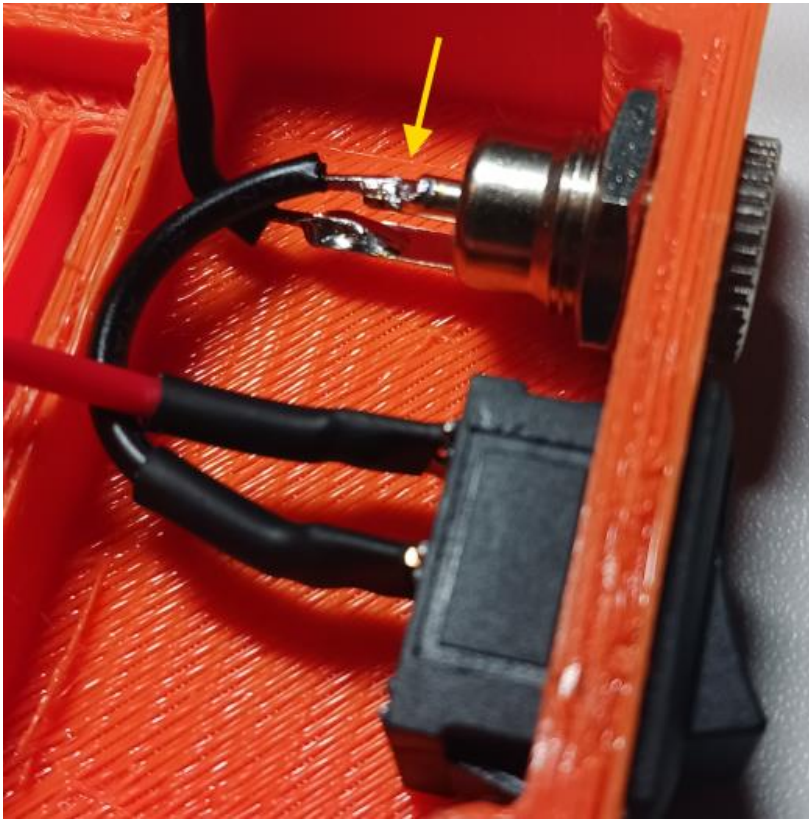

Remove 3mm of sheathing from the rocker switch black wire and then solder the rocker switch black wire to the positive center terminal on the 5.5mm power jack as shown.

NOTE: the positive terminal is the one in the center of the power jack. Make sure solder connections to each of the power jack terminals are solid and that there are no stray strands of wire and that there are no possibilities of a short between the power jack terminals.

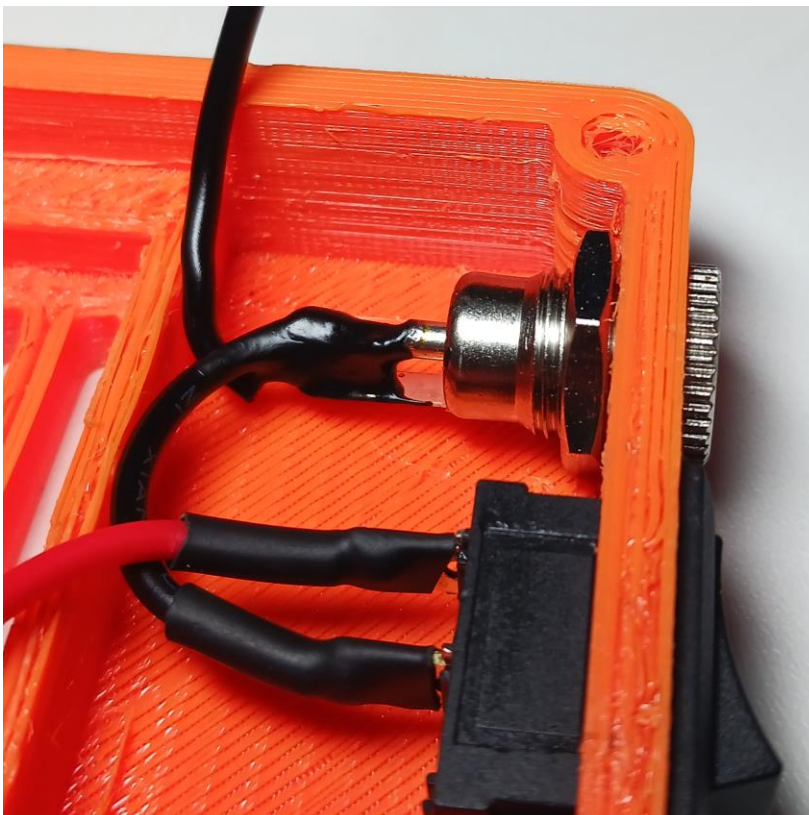

Apply liquid electrical tape to the power jack terminals ensuring there is possibility of a short between the power jack terminals.

NOTE: allow liquid electrical tape to dry and harden completely before moving to the next step.



Feed red and black wires through the hole shown in the auxiliary enclosure.

NOTE: A fan is not needed for the pneumatic gripper so the fan recess area can be left empty.

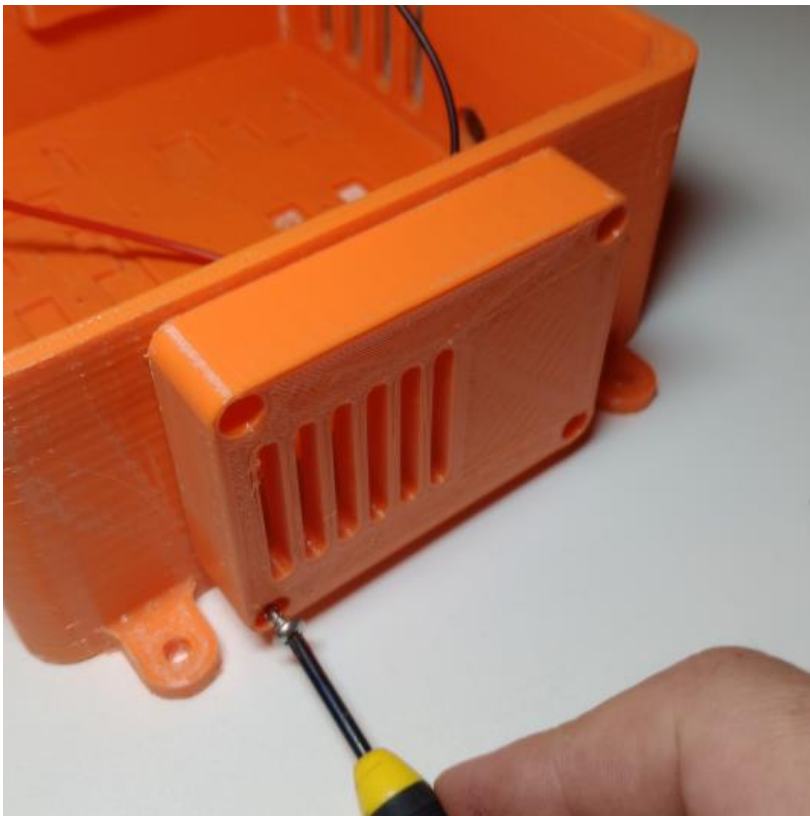

Secure fan switch cover to the auxiliary enclosure using (4) #6 thread form screws.

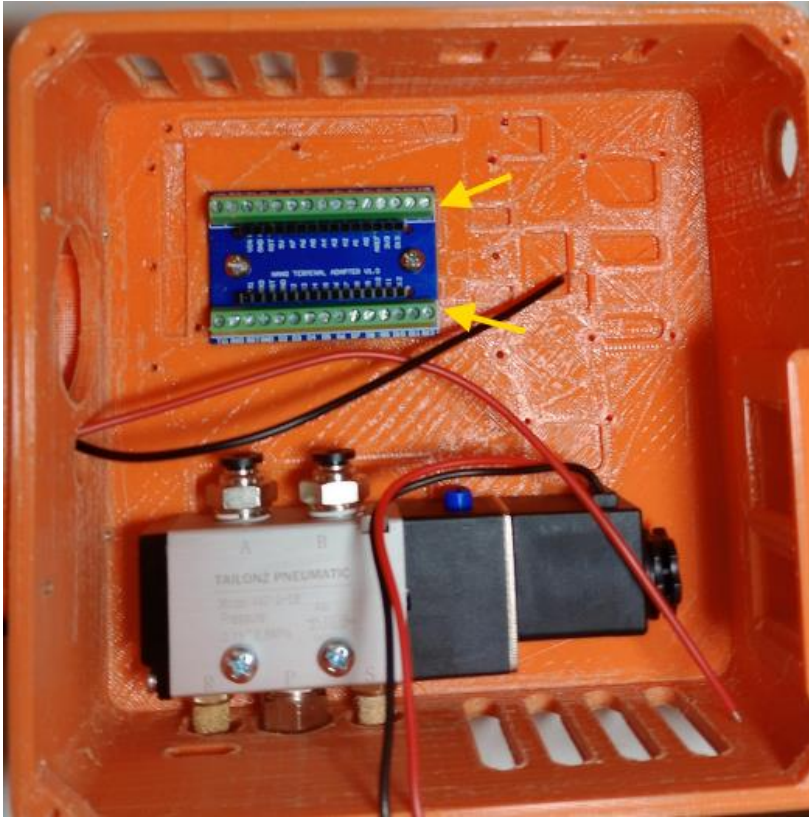

Secure Nano breakout board to enclosure in the position shown and secure with (2) #6 thread form screws.

Make sure to orient the board with the D12 and D13 terminals to the right as indicated by the yellow arrows.

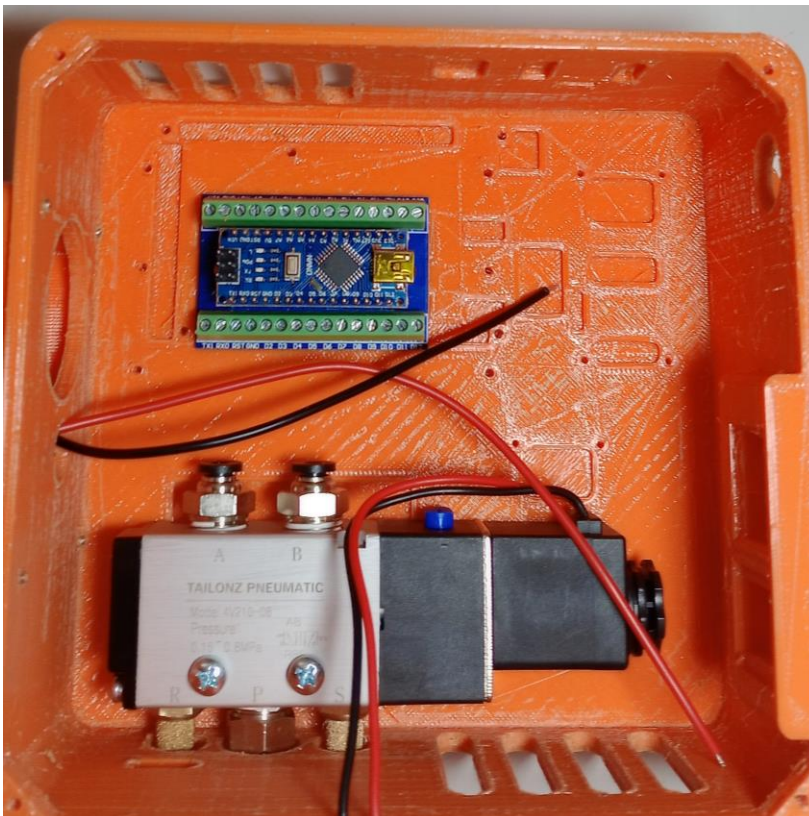

Insert Nano board into terminal breakout board as shown.



Install 5v relay module and secure with (4) #2x.25 screws.

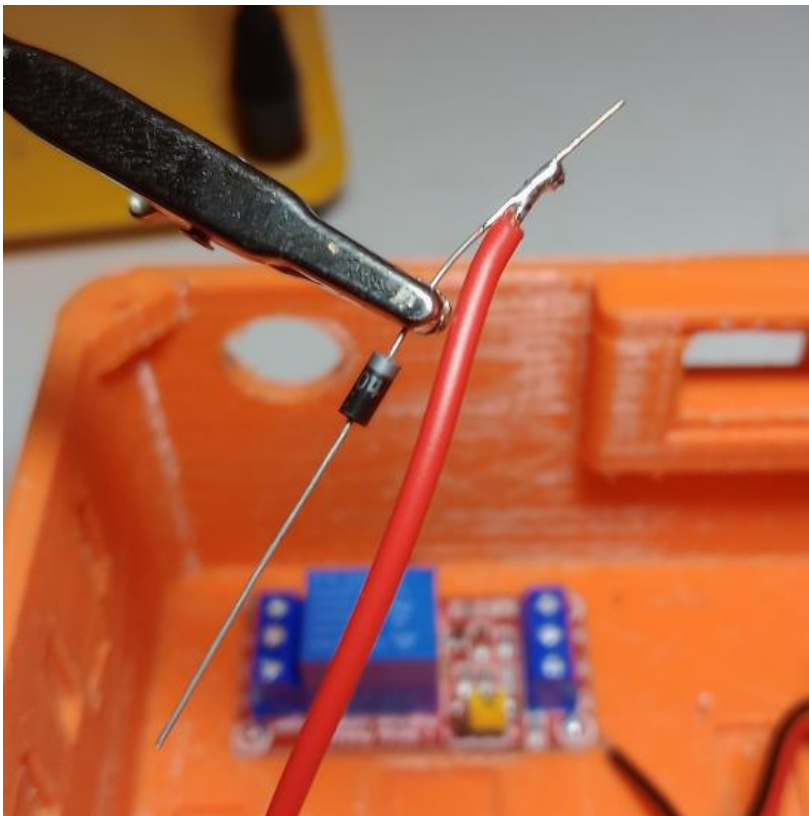

Solder the red wire (coming from fan enclosure) to the 1N4004 diode as shown. Make sure to solder the red wire on the side of the diode that has the silver band.

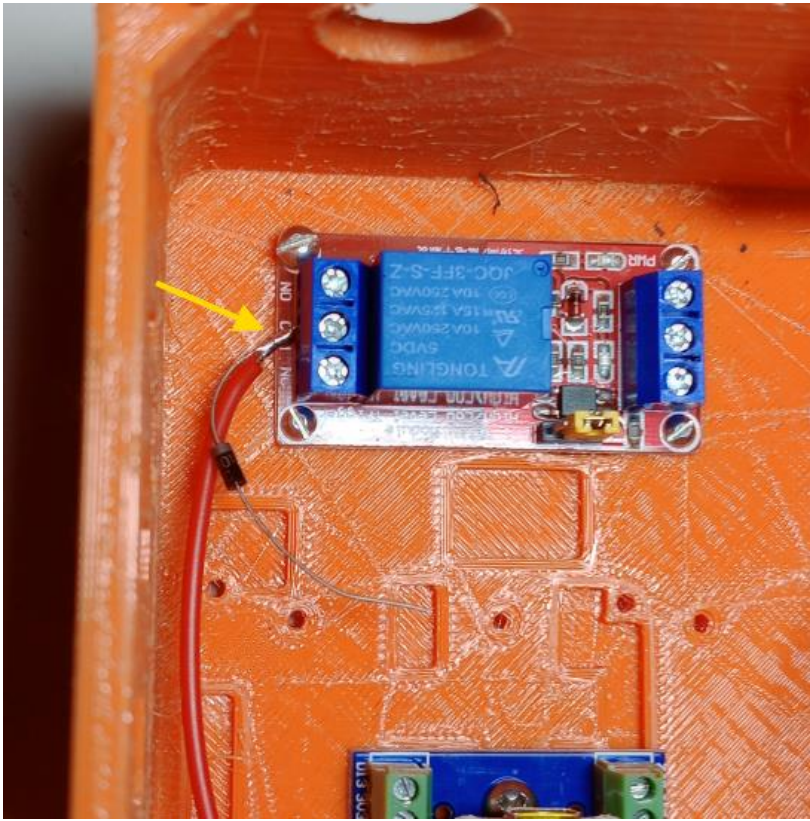

Connect the red wire with diode to the center COM terminal of relay.

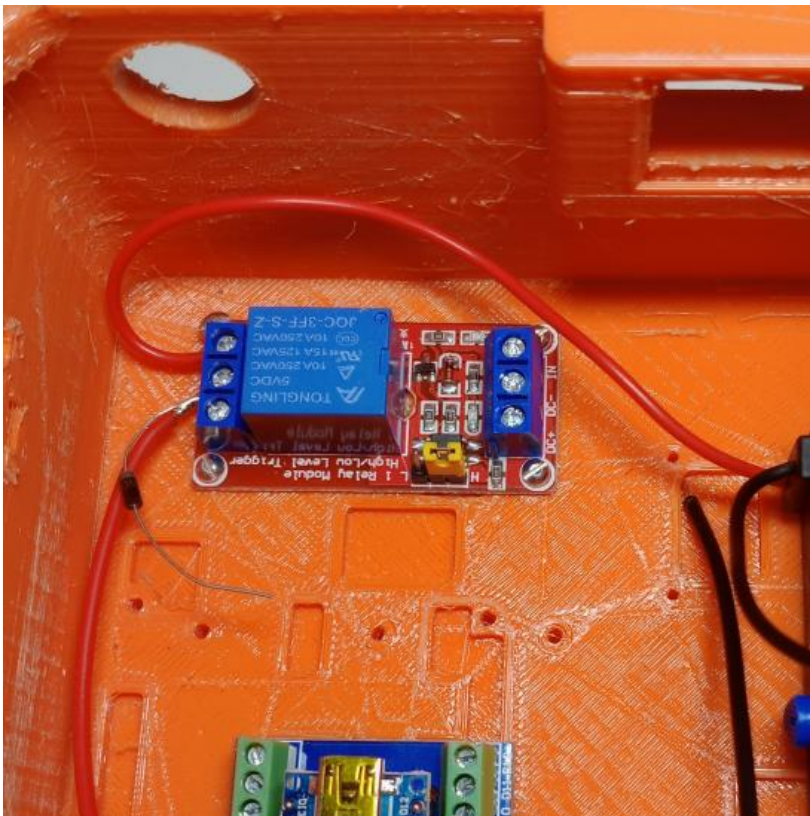

Trim red wire from solenoid valve to length shown and then connect to the top "NO" terminal of relay.

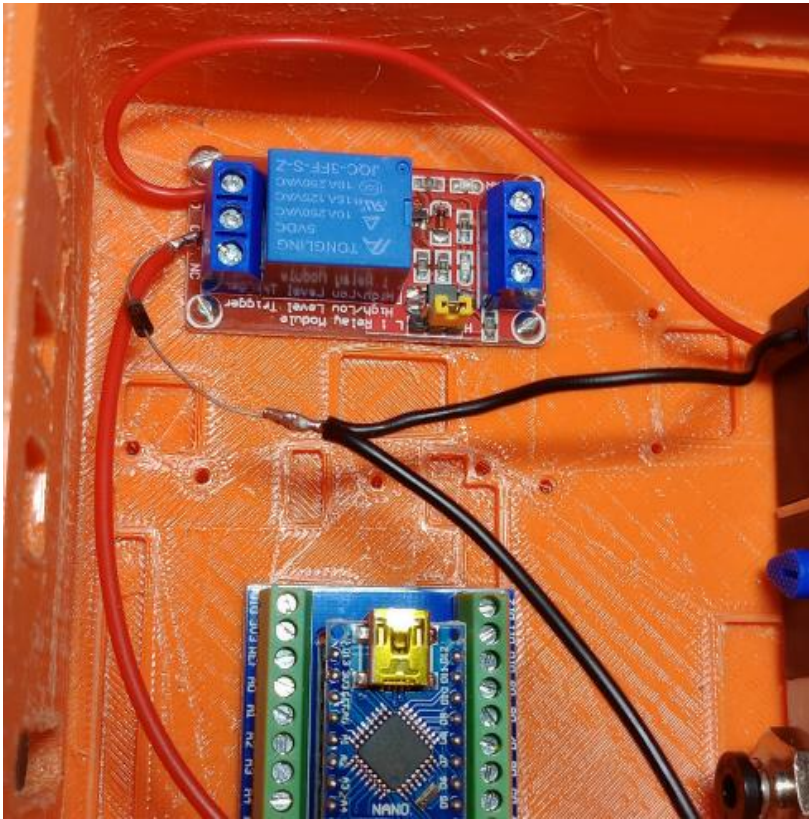

Trim the solenoid black wire to the length shown, then solder the solenoid black wire and fan enclosure black wire together and then solder those to the other end of the diode as shown.

NOTE: the diode serves to eliminate EMF interference when the solenoid actuates. If this interference is not removed the Nano board can drop its connection to your PC each time the solenoid actuates.

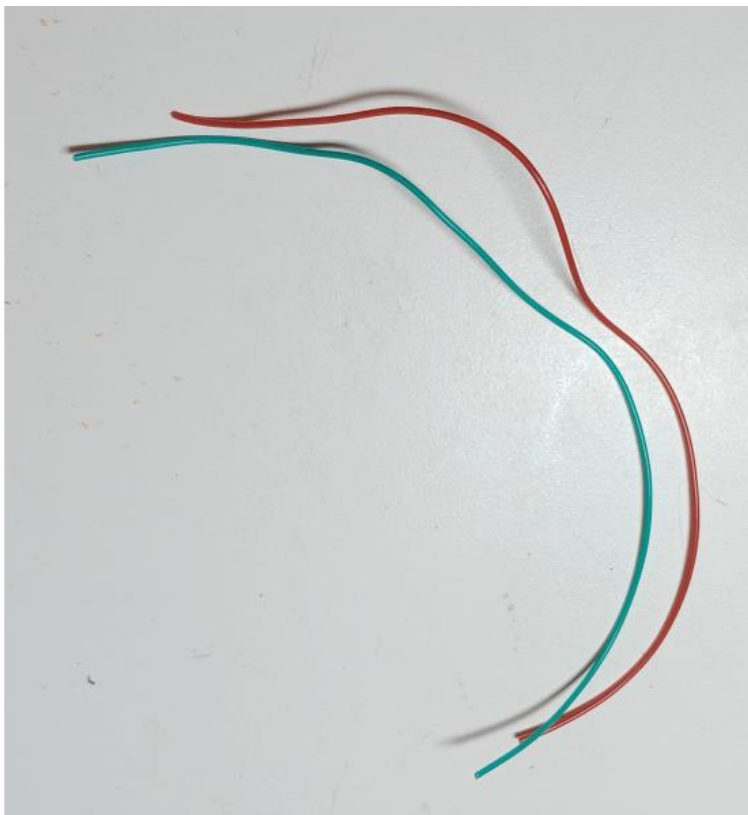

Cut a 20cm length of red and green 22awg wires that was leftover from the J2 or J3 encoder wires that were removed.

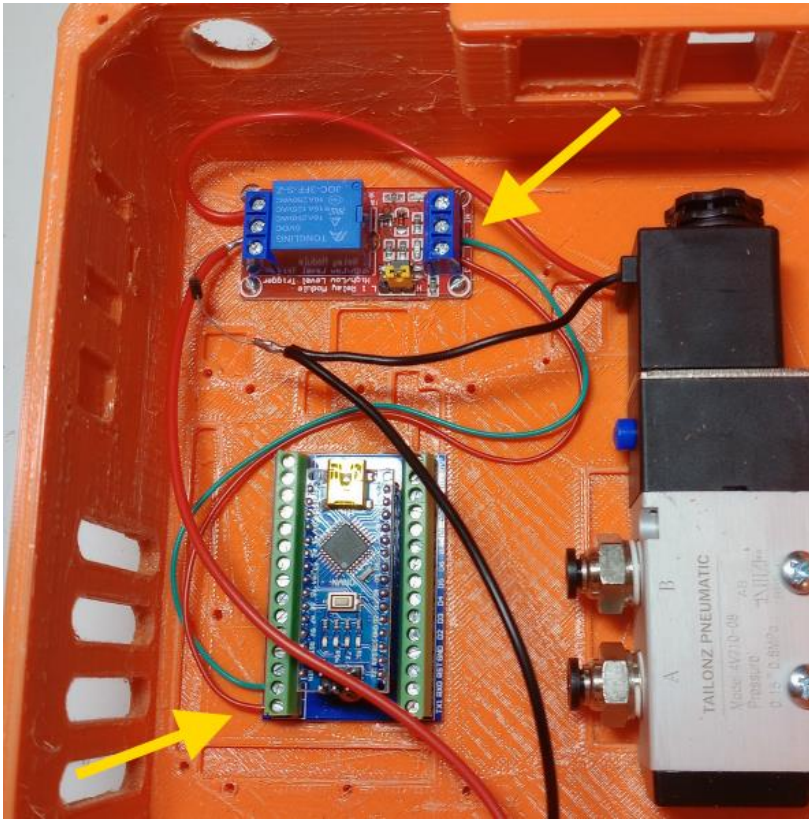

Strip ends of the red and green wires and then connect the Nano board to the relay as follows:

- Red wire from nano VIN terminal to the relay DC+ terminal.
- Green wire from the nano GND terminal to the relay DC- terminal.

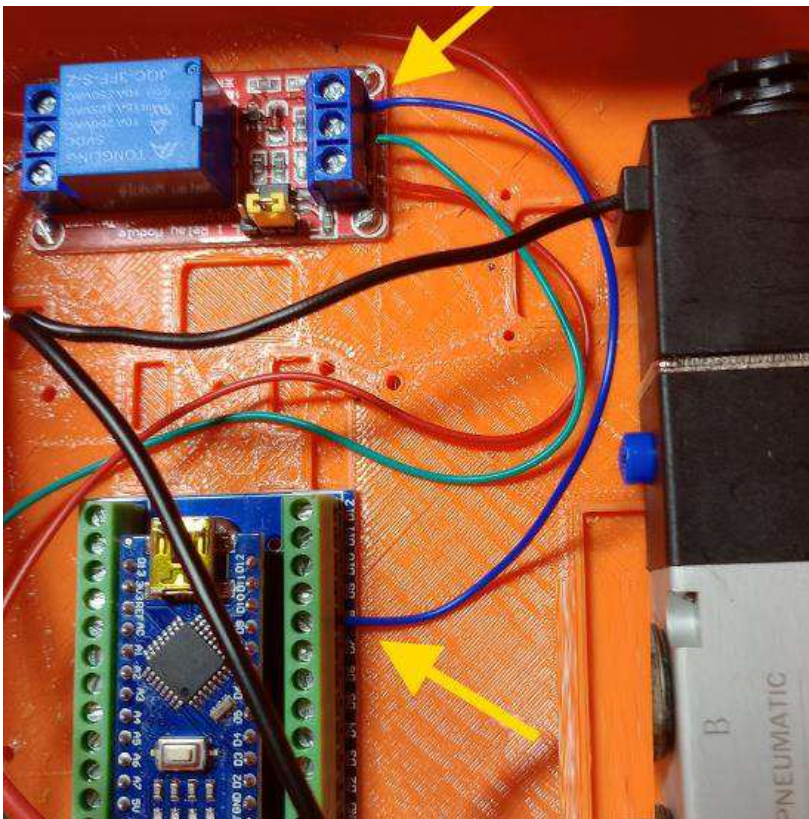

Cut a 15cm length of the 22awg wire that was leftover from the J2 or J3 encoder wires that were removed.

Connect the blue wire from the nano D8 terminal to the relay IN terminal.



Install USB keystone jack into enclosure as shown, then connect USB cable from keystone jack to Nano board.

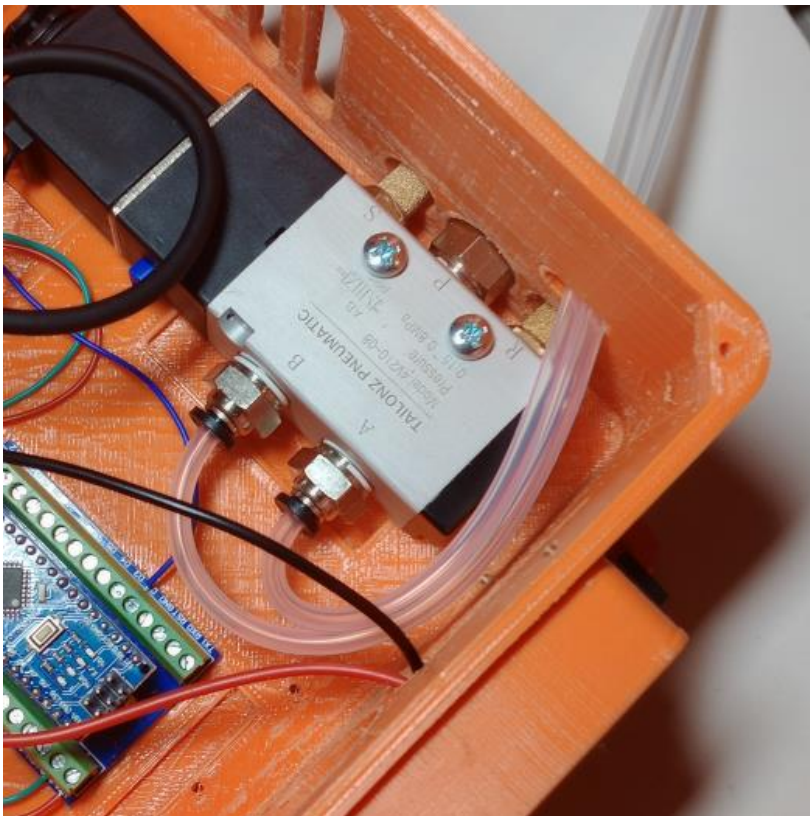

Route pneumatic lines from robot into enclosure as shown and connect to the A and B port push connect fittings.



Install auxiliary enclosure lid and secure with (4) #6 thread form screws.

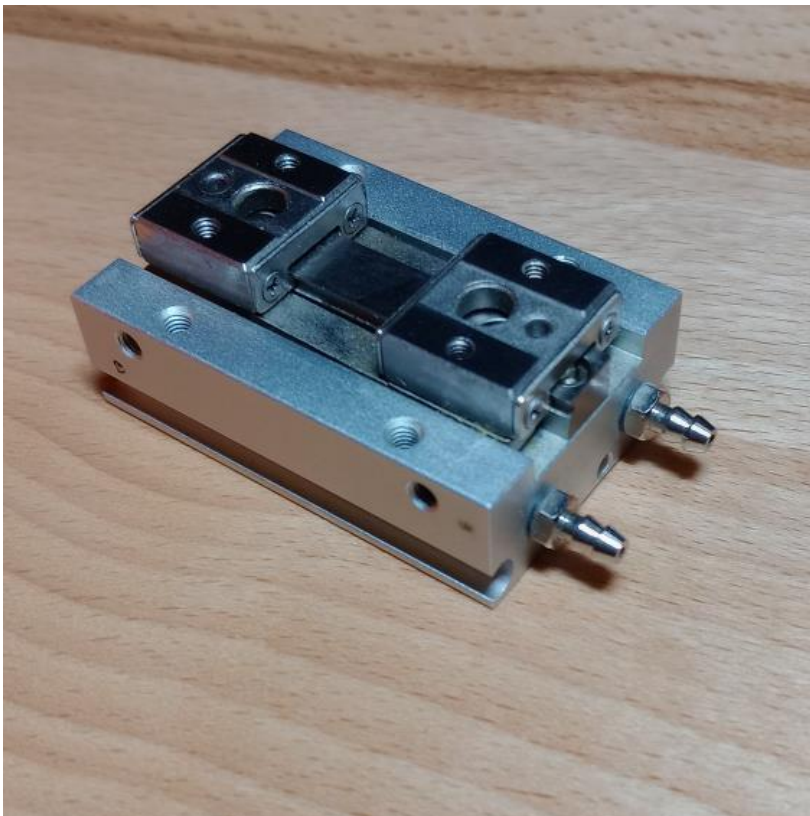

Install 3mm barb fittings to MHF2-8D1 gripper as shown.

NOTE: 3mm push connect or 90 degree fittings can be used if needed.

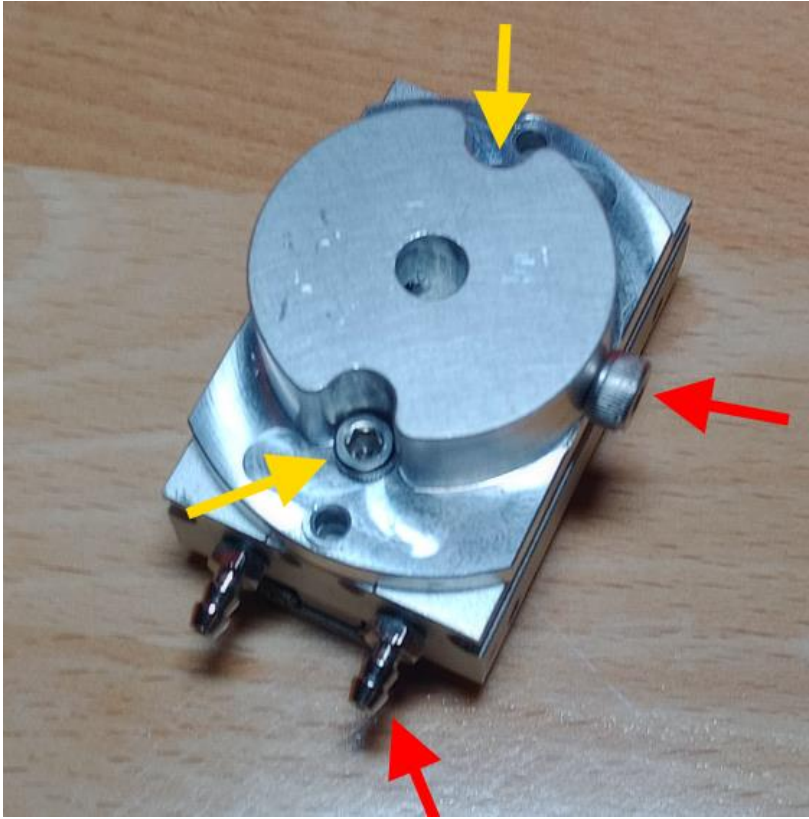

Attach J6 gripper mount to MHF2-8D1 using (2) M3x8 cap screws. (yellow arrows)

NOTE: make sure the M4 timing cap screw on gripper mount is to the right in relation to the barb fittings facing down as shown in photo. (red arrows)

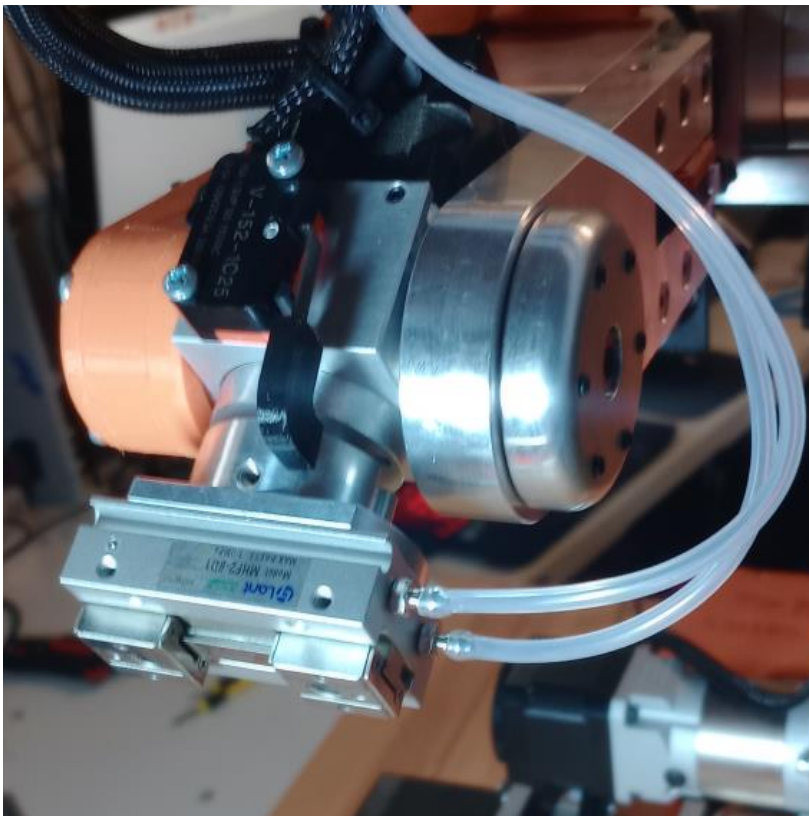

Install gripper and J6 mount onto robot as shown then connect the pneumatic air lines to the barb fittings.

Make sure gripper mount M4 timing cap screw is facing down.

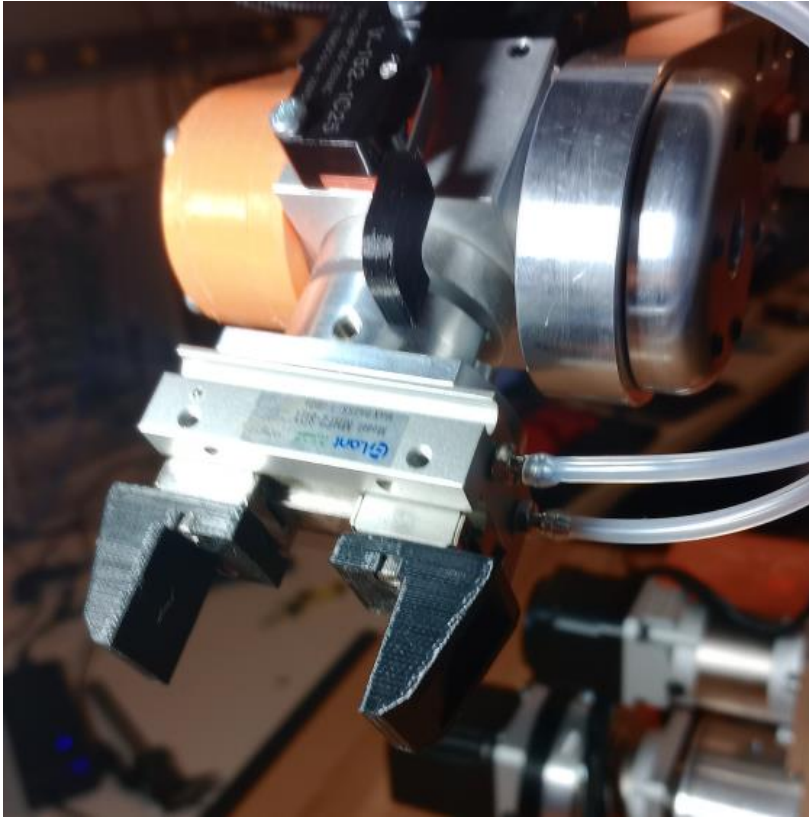

Install gripper jaws on MHF2-8D1 gripper using (4) M2.5x6 cap screws.

NOTE: you can design and install any jaws you require. These jaws are available in the 3D print files.

Open the Arduino software, from the tools, AVR boards menu select the Arduino Nano.

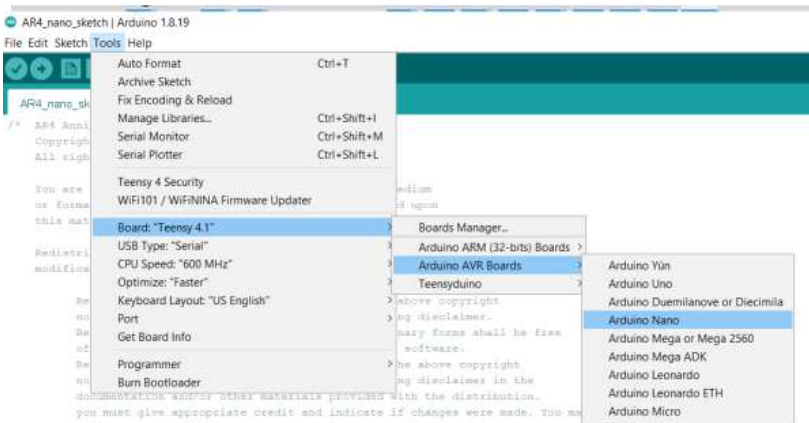

From the tools, processor menu select the (old bootloader) option.

The standard ATmega328 option may work but I have had better luck on most boards with the old bootloader.

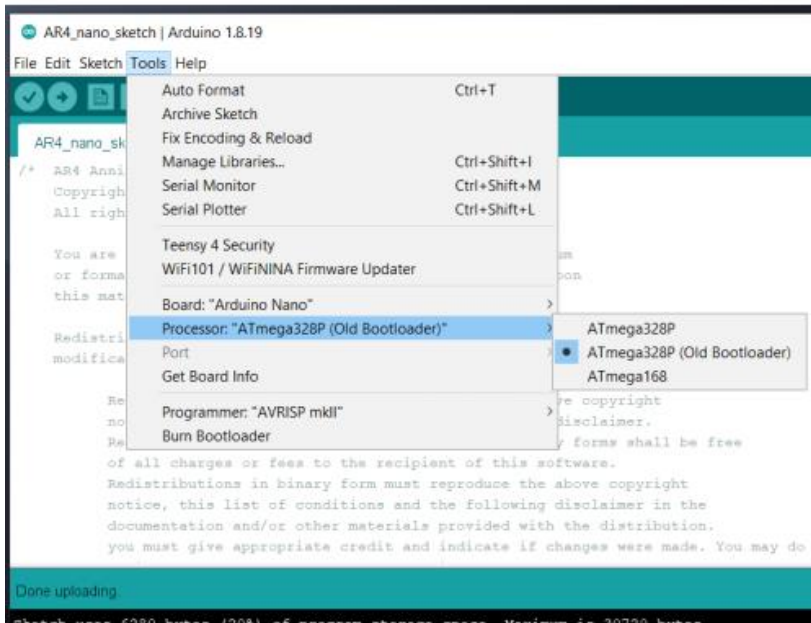

Device Manager

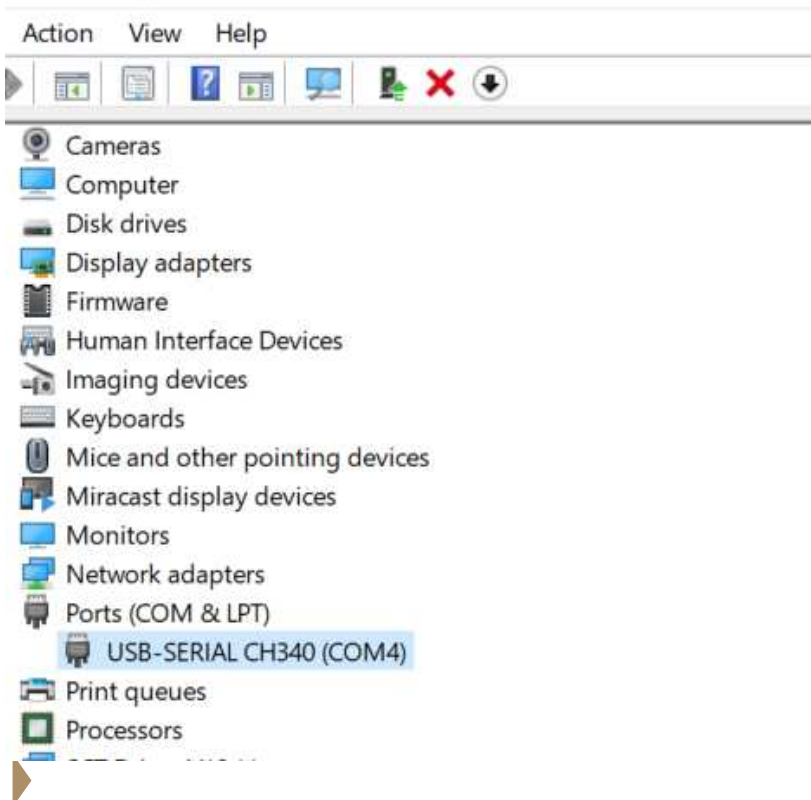

Open your device manager and double check which COM port your nano board connected to. In my case it's the only COM device plugged in at the moment so I know its COM4 but you can unplug and plug it back in and see which COM port updates on the list.

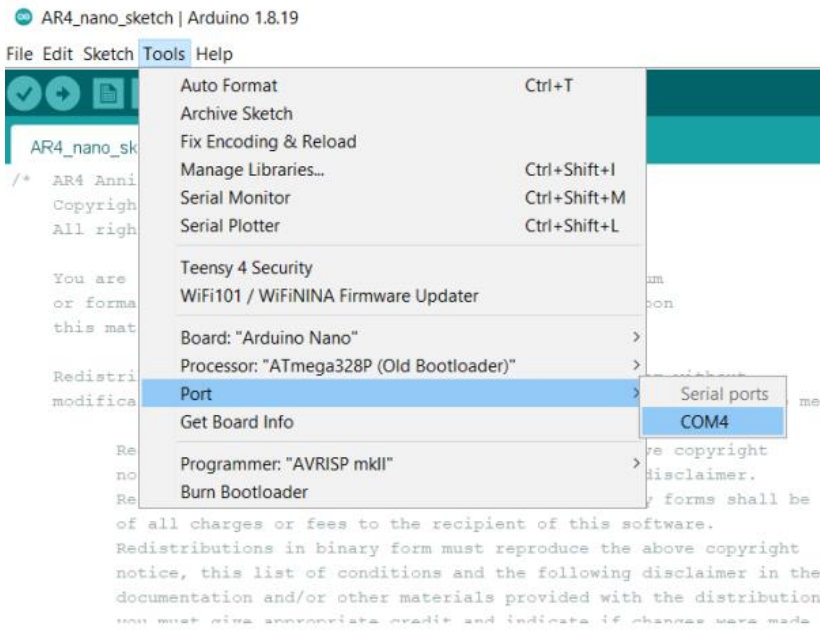

Double check from the tools, port menu that its set to the same COM as your device manager. In my case its COM4.

NOTE: In the AR4 software you will also want to set your Nano COM to this com port.

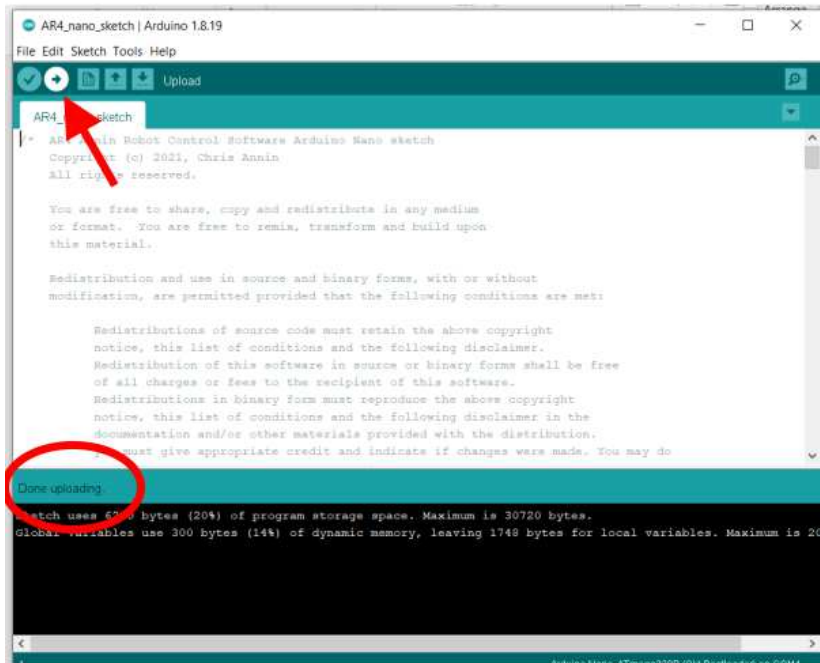

Press the upload sketch button to load the program to the Nano board. It should say done uploading when complete.

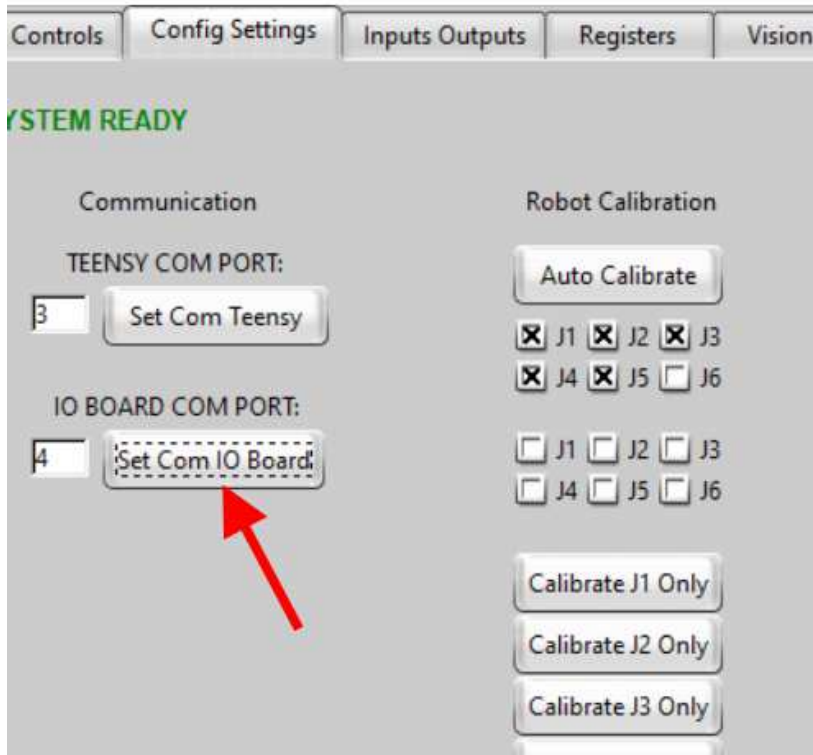

Open the AR4 software, from the config settings tab set the COM port as noted in previous steps to the correct number and then press the Set Com IO Board button.

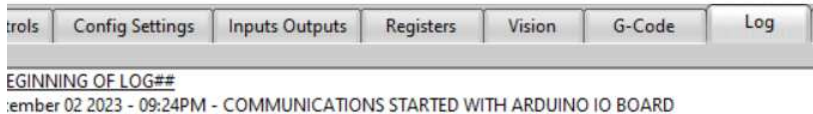

In the software log file it should say communications started with IO board.





Plug 24vdc power supply into auxiliary enclosure and power on solenoid valve.



Connect 1/4 or 6mm supply pressure line to air compressor.

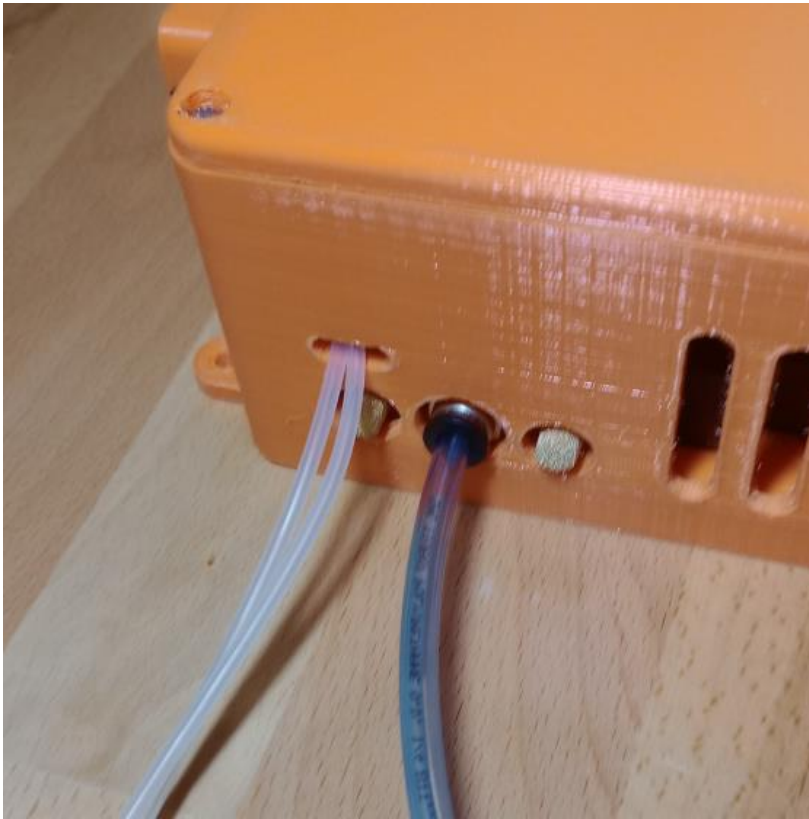

Connect 1/4" or 6mm supply pressure line from compressor to solenoid fitting as shown.

Software Ver 3.3

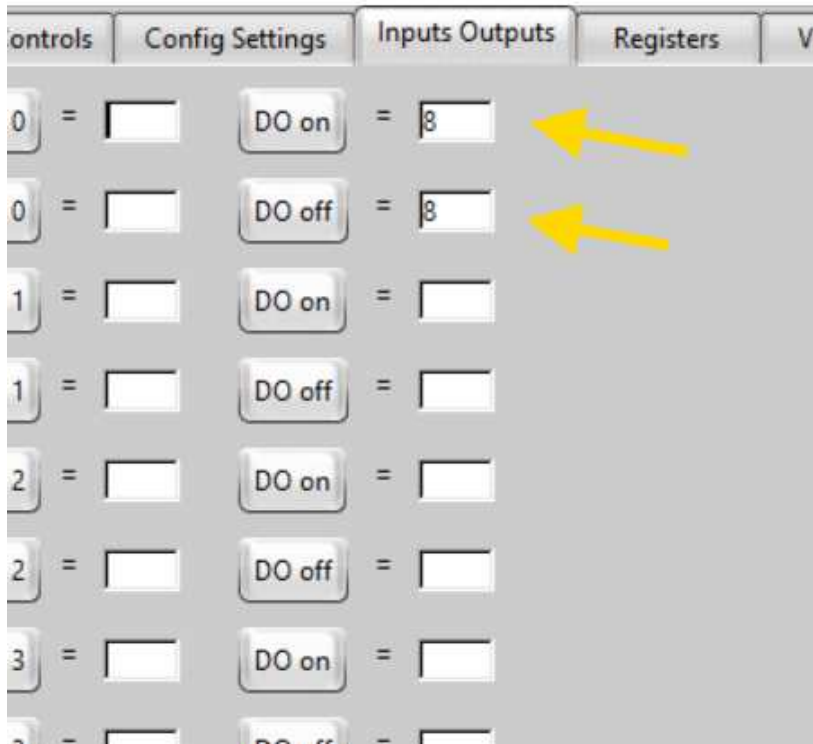

In the AR4 software from the Inputs Outputs tab enter output #8 in the fields shown.

You should now be able to toggle your gripper open and close using the DO on and DO off buttons.

NOTE: you can wire your solenoid valve or additional solenoid valves to any available output. In this example we have used 8 as it's the first available output for the AR4 nano program sketch.

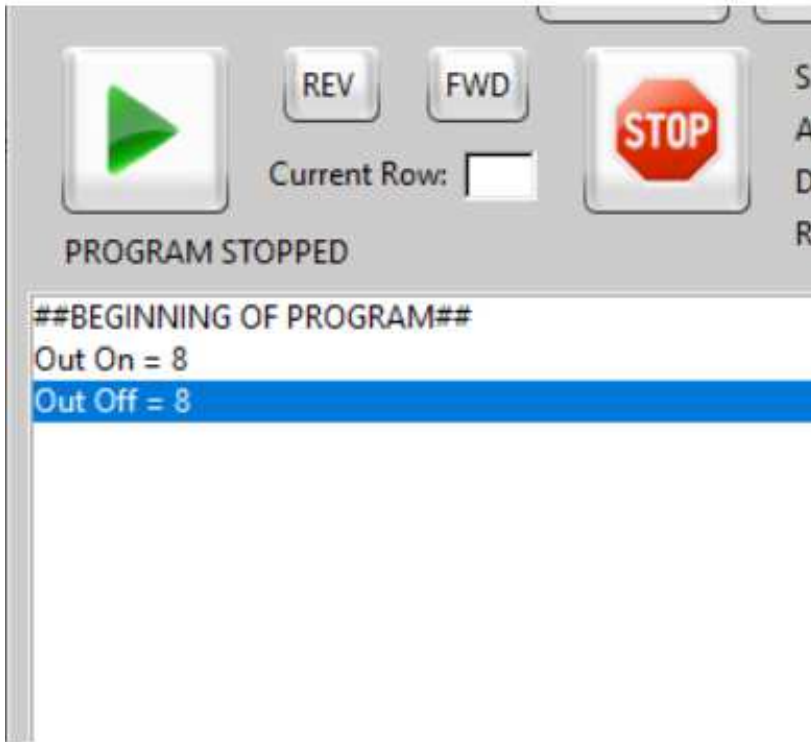

You can control the pneumatic gripper in the robot program using the lines of code shown generated from the “Set Output On” and the “Set Output Off” command buttons.

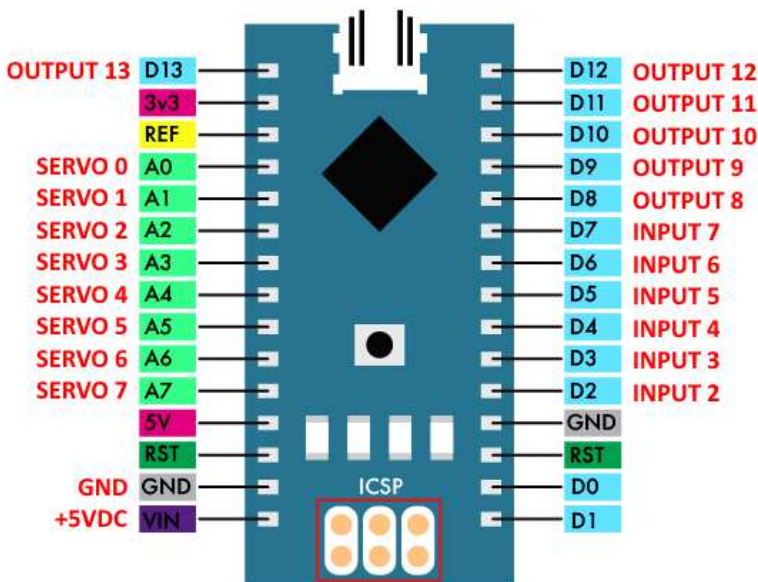

REFERENCE:

The Nano sketch file for the AR4 robot allocates the servo and input / outputs indicated in red text in the diagram shown.

Using the Nano you can control up to 8 servos, 8 digital outputs and monitor up to 8 inputs.

Note the Arduino Mega board can also be used if additional IO is required for your project.

CHAPTER 5

SERVO GRIPPER

The robot can have multiple different end effectors depending on your needs. This chapter covers the installation of an electric servo gripper.

Please also see the tutorial video on grippers and IO connections:
<https://youtu.be/76F6dS4ar8Y>



Servo Gripper Bill of Materials



25kg Servo Gripper – DS3225

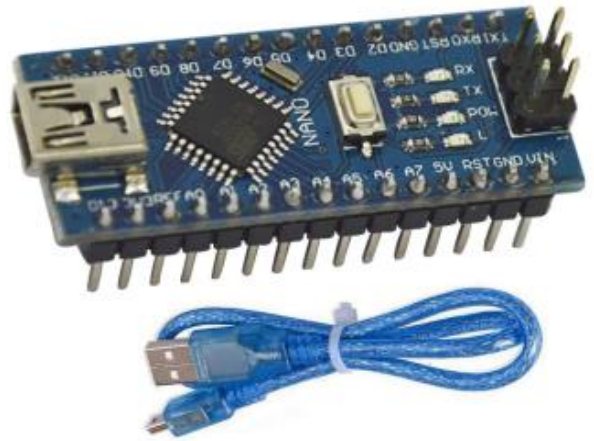

Arduino Nano control board (Arduino Mega can also be used)

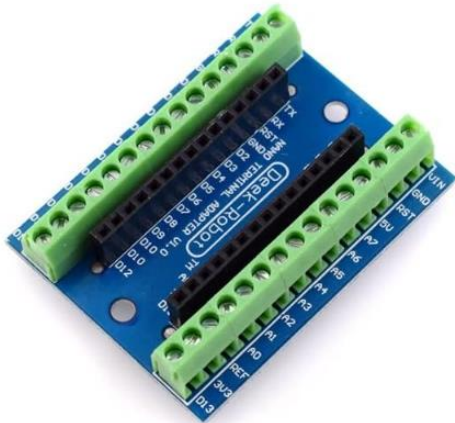

Terminal Adapter Expansion Board for Arduino Nano



Micro USB to USB C Cable

-

Any short length Mini to C cable can be used.





5V 3A Power Supply Adapter



18awg 4 conductor cable (200cm long)

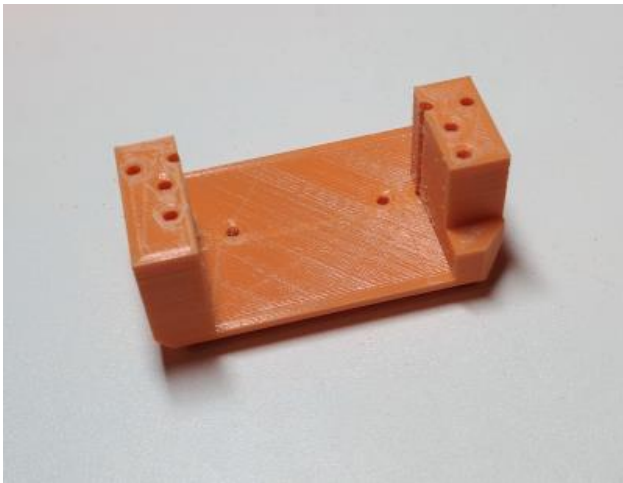

AR4_SG1_base
(3D print – PETG 100% infill)



AR4_SG1_carriage
(3D print – PETG 50% infill)



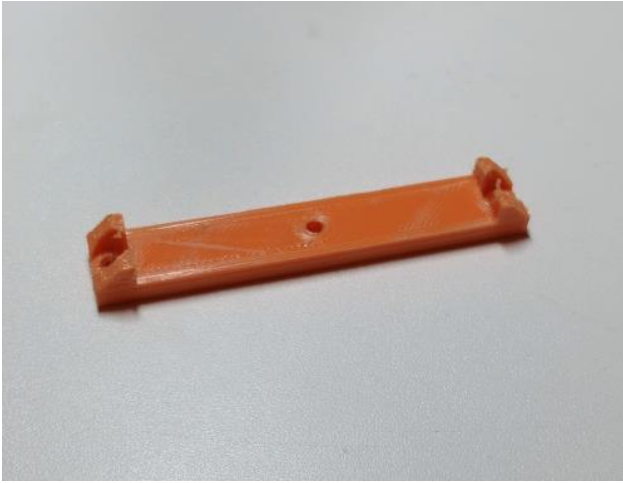

AR4_SG1_center_bar
(3D print – PETG 50% infill)



AR4_SG1_gear
(3D print – PETG 50% infill)

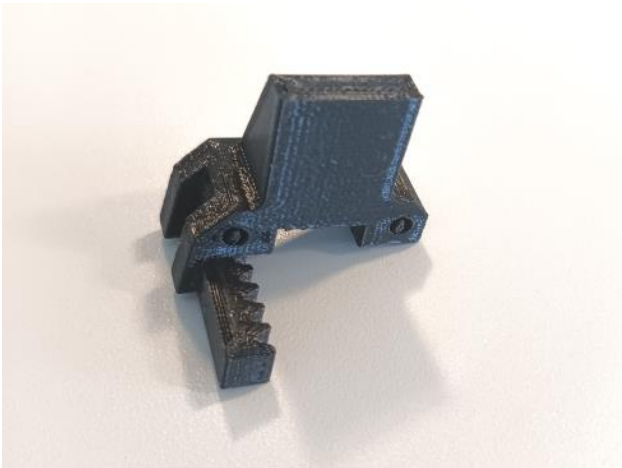

AR4_SG1_jaw1
(3D print – PETG 50% infill)

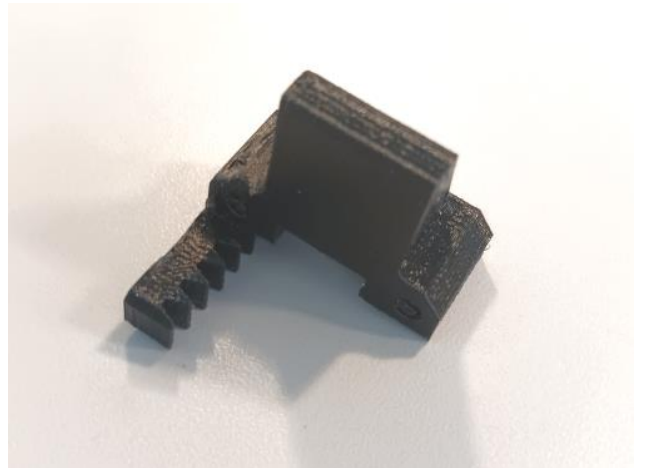

AR4_SG1_jaw2
(3D print – PETG 50% infill)





USB-C Keystone Jack.

-

This can be either straight or 90 degree.



5.5mm DC power jack socket.



KCD1 SPST rocker switch with lead wires.



GX16-4 aviation plugs.
Qty (2)





Auxiliary enclosure

-

The 3D print file for this part can be found along with the robot print files on the downloads page.



Auxiliary enclosure lid

-

The 3D print file for this part can be found along with the robot print files on the downloads page.



Super Glue



J1 Base enclosure fan cover

-

This is the same 3D printed part that is used on the robot base.





(x2) 3mm stainless rod cut to length of 70mm



3mm stainless rod cut to length of 16.5mm



20awg 2 conductor black and red wire..
63cm



Servo Gripper Assembly



Cut 25cm length from
18awg 4 conductor cable.



Use jacket stripping tool to
assist in removing jacket.
You should now have (4)
18awg wires that are 25cm
long.

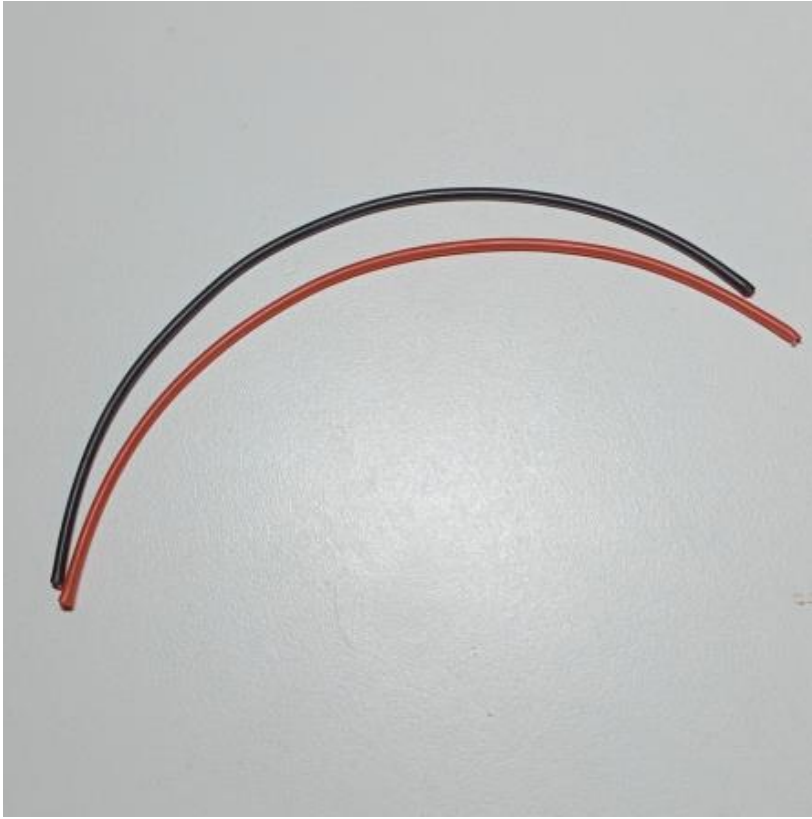

Cut 25cm lengths of the 20awg 2 conductor black and red wire.

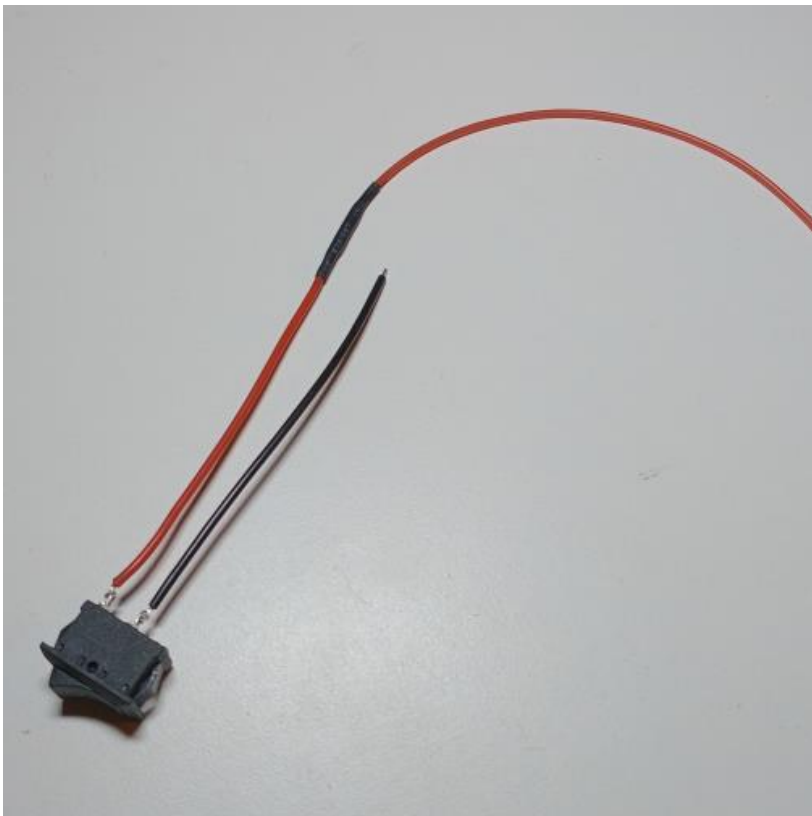

Solder and heat shrink 25cm red wire to extend the rocker switch red wire so that the total length of the red wire is 34cm long.

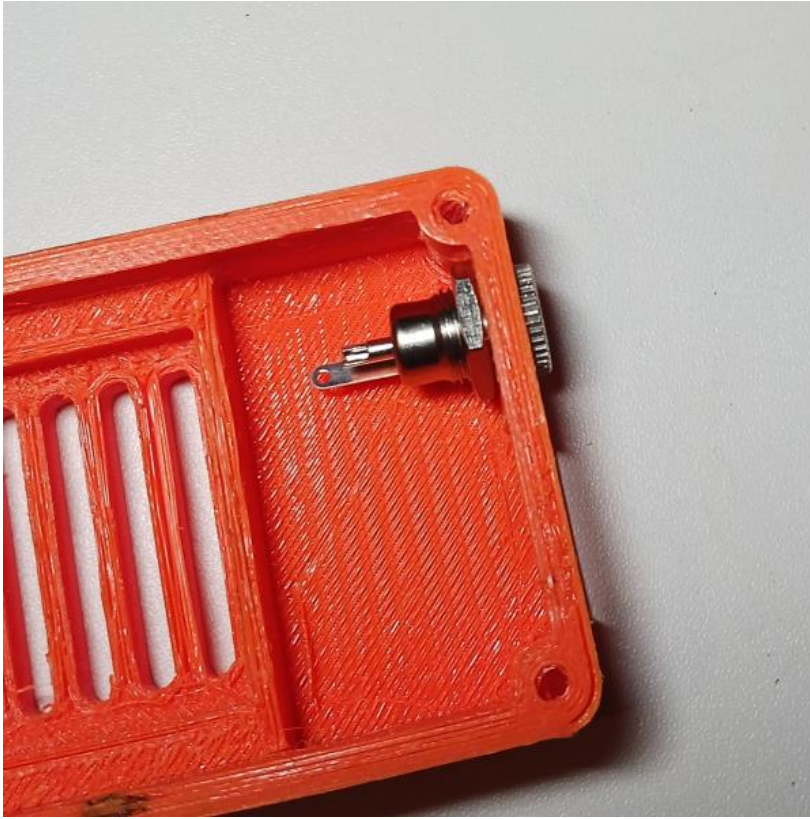

Remove all build structure from 3D printed Base Enclosure Fan Cover then install the 5.5mm power jack as shown.

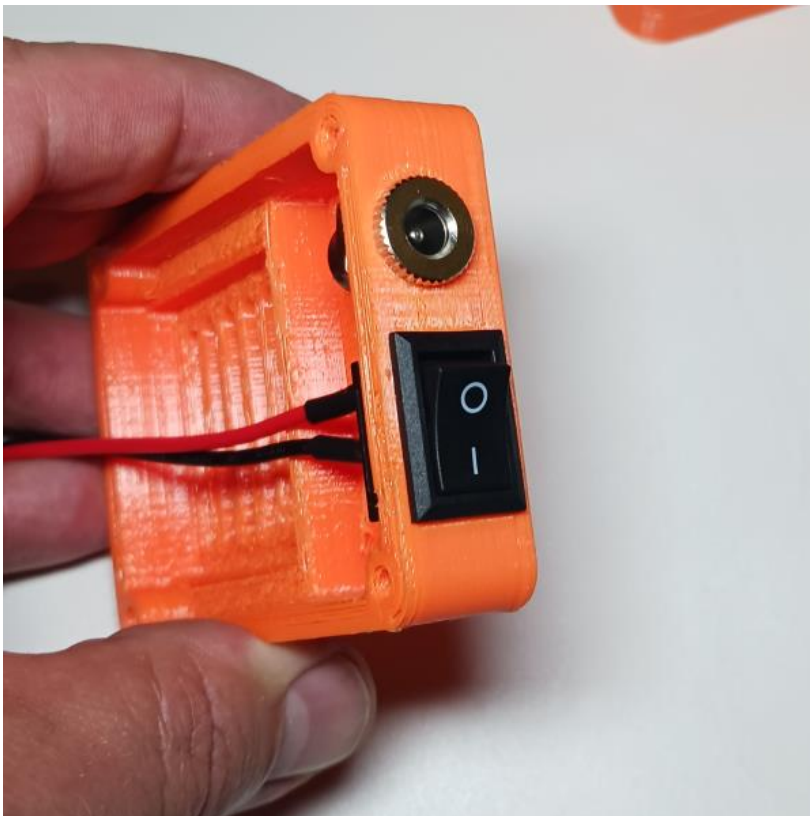

Install rocker switch as shown. Rocker switch will snap into position.

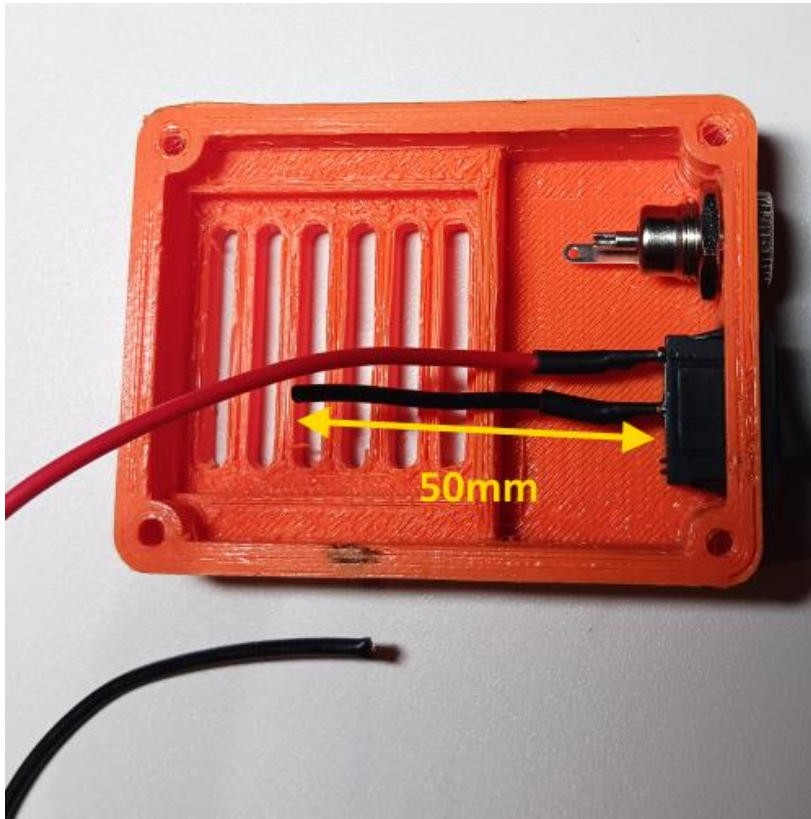

Cut the rocker switch black wire as shown leaving 50mm of wire extended from the rocker switch.



Strip 3mm of sheathing from the end of the black 25cm long wire from step 2 and then solder the wire to the 5.5mm power sockets ground connection tab as shown.

NOTE: The ground connection tab is the longer tab coming from the socket outer housing as shown.

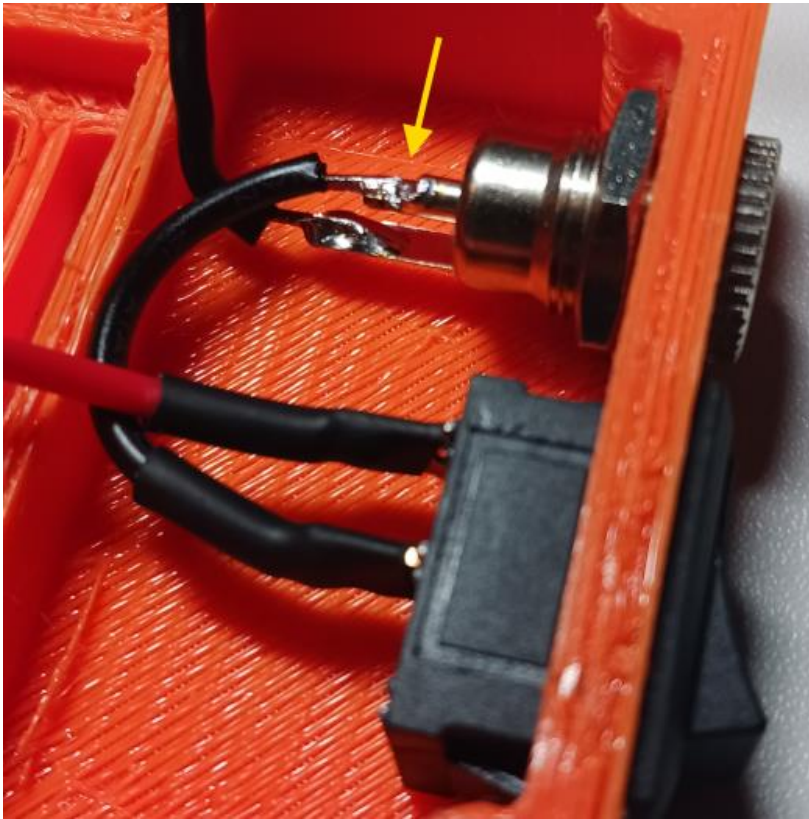

Remove 3mm of sheathing from the rocker switch black wire and then solder the rocker switch black wire to the positive center terminal on the 5.5mm power jack as shown.

NOTE: the positive terminal is the one in the center of the power jack. Make sure solder connections to each of the power jack terminals are solid and that there are no stray strands of wire and that there are no possibilities of a short between the power jack terminals.

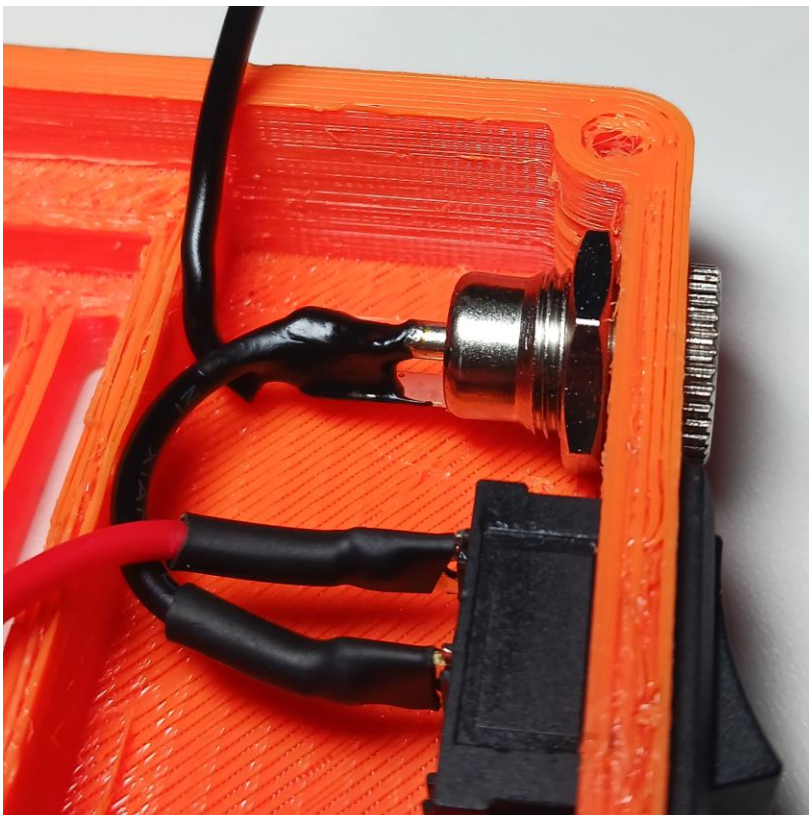

Apply liquid electrical tape to the power jack terminals ensuring there is possibility of a short between the power jack terminals.

NOTE: allow liquid electrical tape to dry and harden completely before moving to the next step.

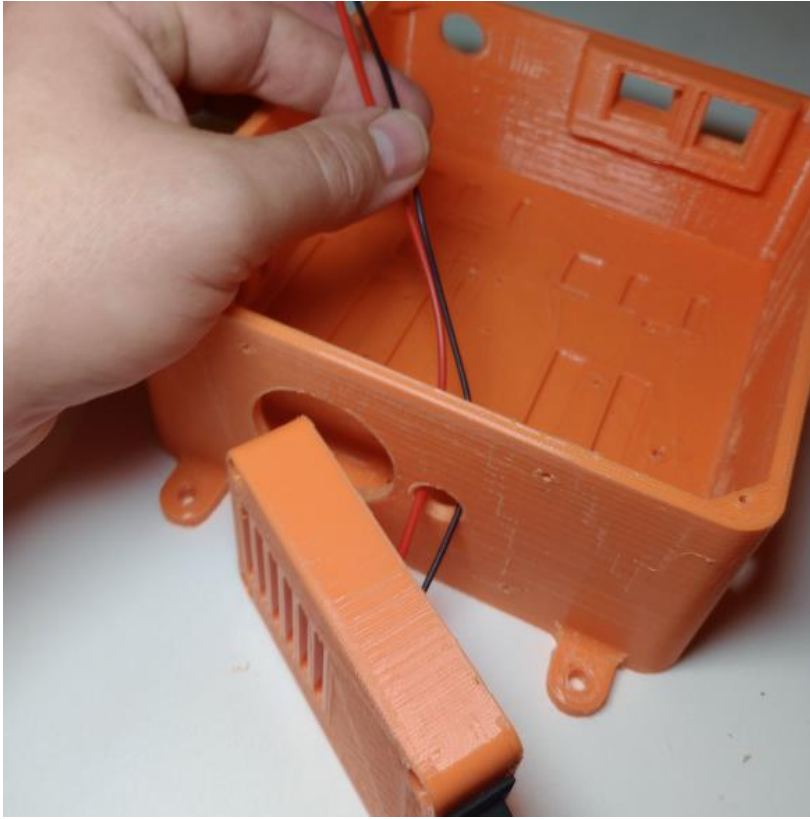

Feed red and black wires through the hole shown in the auxiliary enclosure.

NOTE: A fan is not needed for the servo gripper so the fan recess area can be left empty.

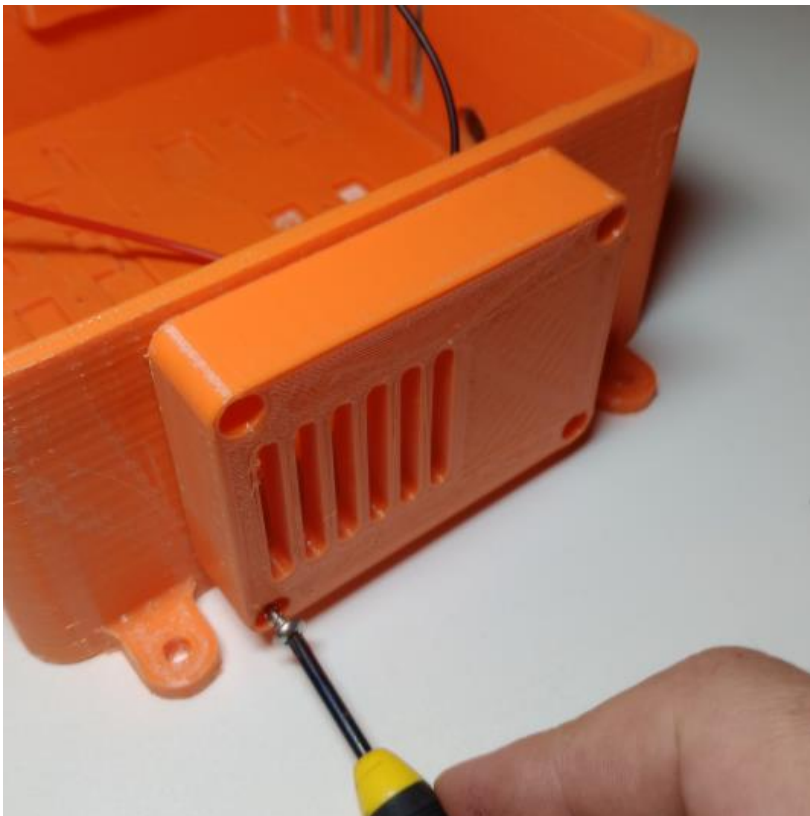

Secure fan switch cover to the auxiliary enclosure using (4) #6 thread form screws.

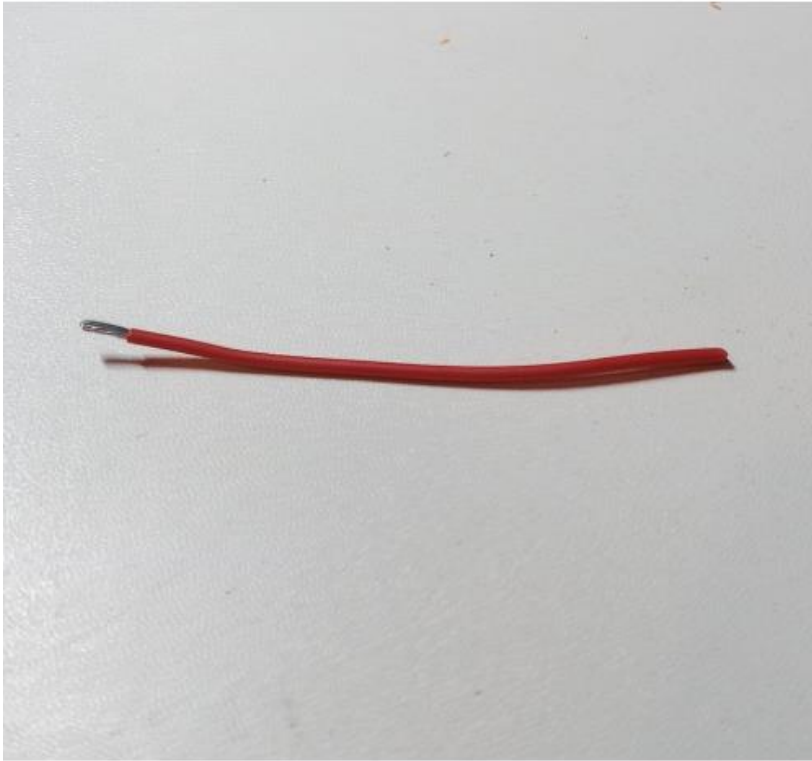

Cut a length 7cm long from the red 18awg wire from step 2.



Solder and heat shrink the 7mm long extension wire to the red power wire coming from the fan / switch cover.

This should extend the red wire so that the red and black wires are now the same length.



Cut a 15cm length of black 22awg wire that was leftover from the J2 or J3 encoder wires that were removed.

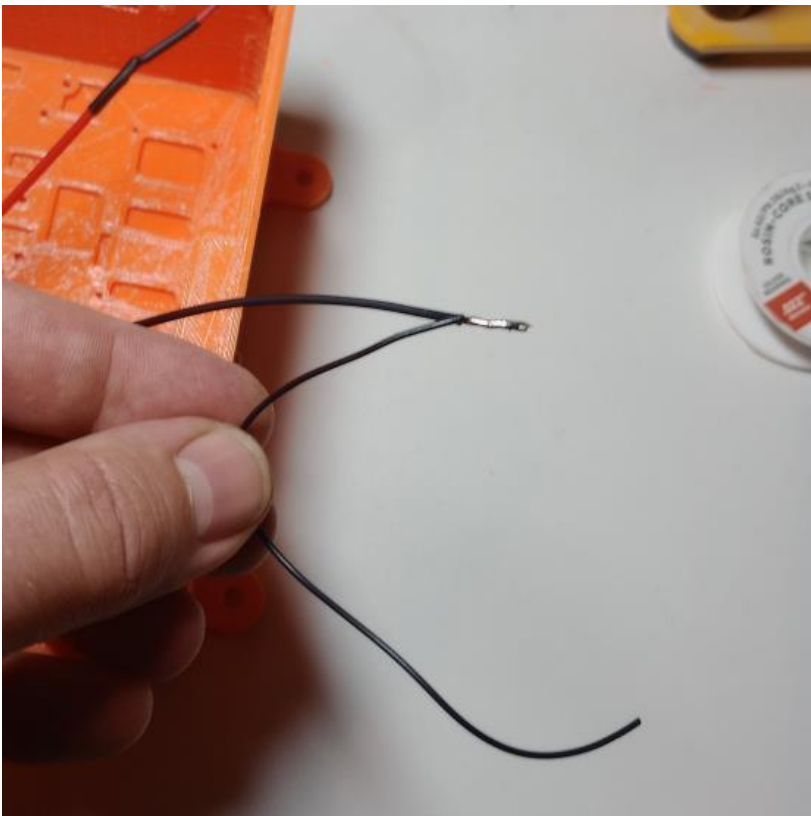

Strip ends of 18awg black wire and 22awg black wire, twist them together and then apply solder to bond them together.

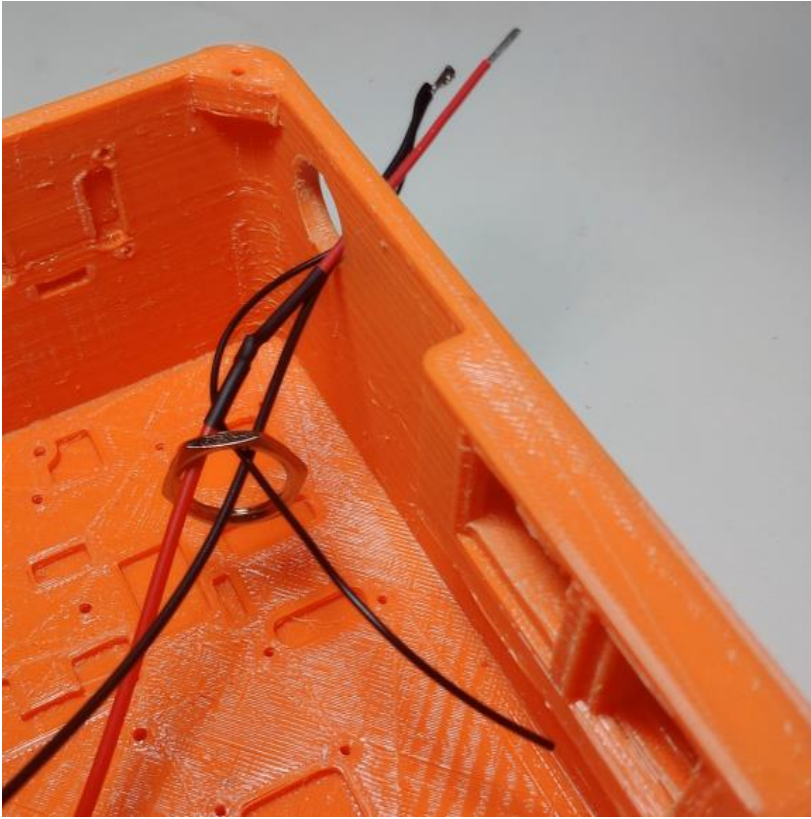

Feed the red and black wires through a nut from the GX16-4 male connector and then out the 16mm hole in enclosure as shown.

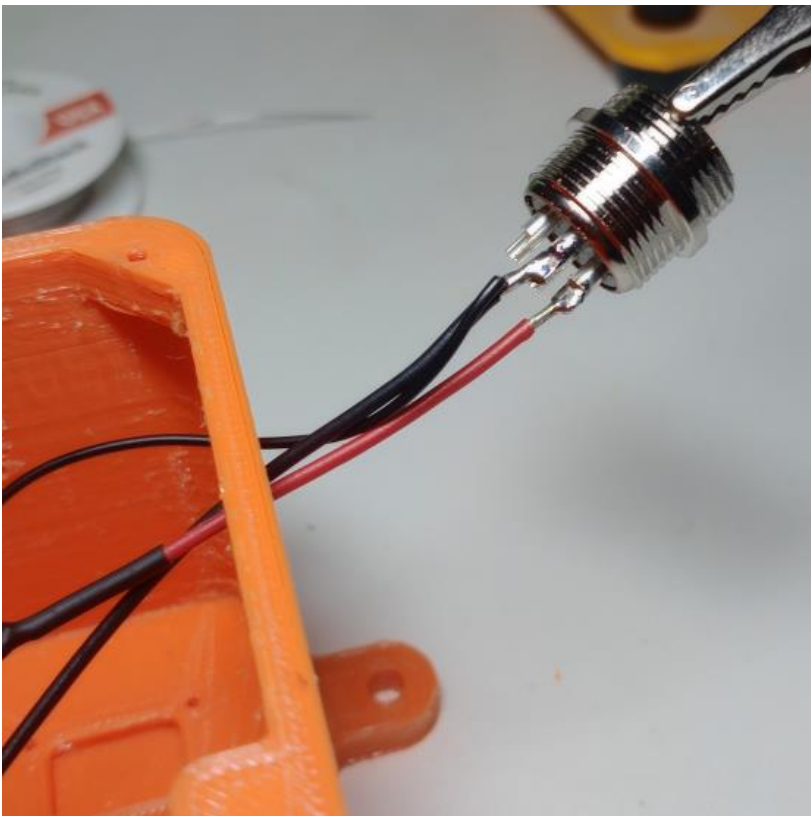

Solder the black pair wire ends to the #1 terminal on GX16-4 connector.

Solder the red wire to pin #2.



Cut a 15cm length of orange 22awg wire that was leftover from the J2 or J3 encoder wires that were removed.

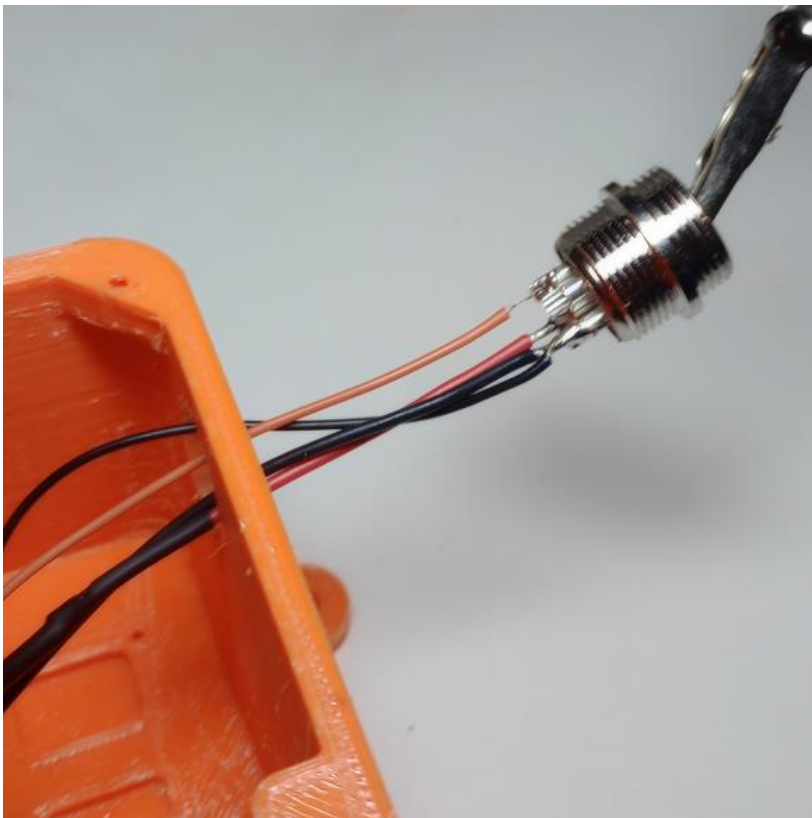

Feed orange wire through the nut and 16mm hole and then solder to the #3 terminal.



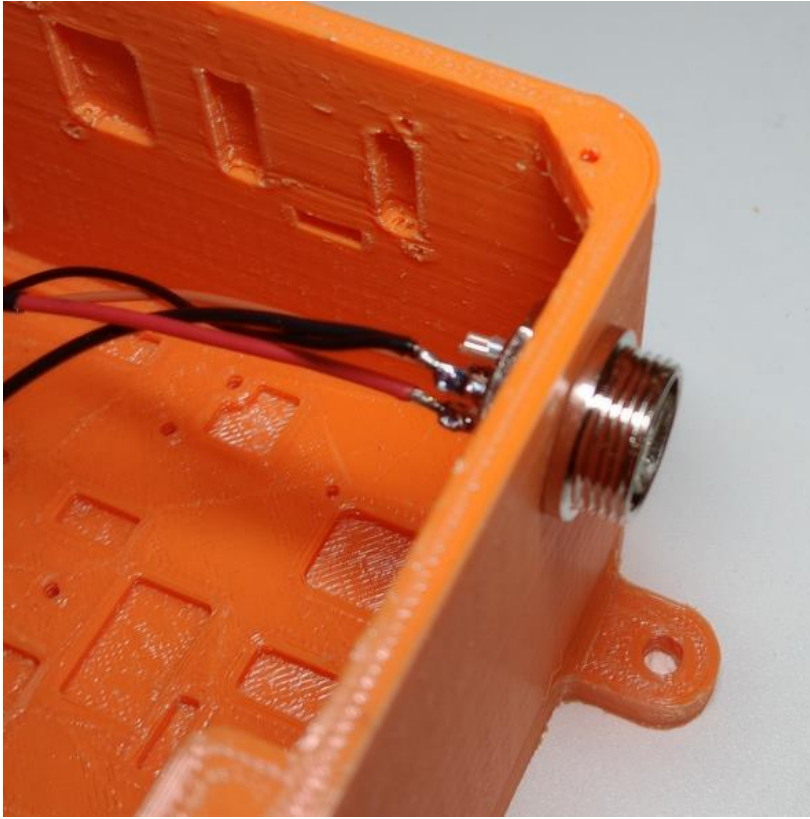

Insert GX16-4 male connector into enclosure and tighten nut on reverse side.

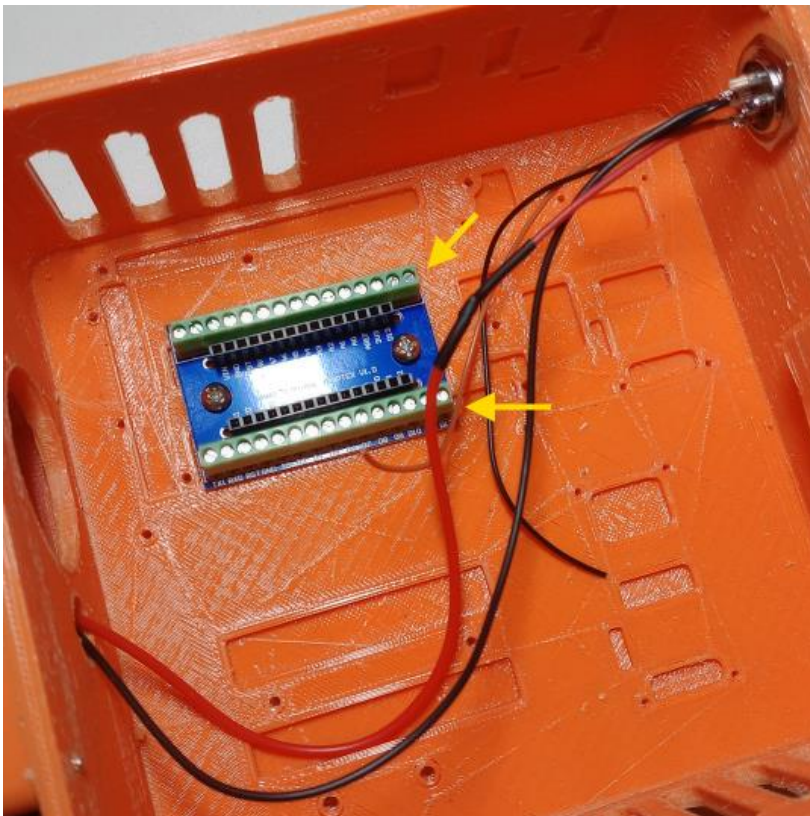

Secure Nano breakout board to enclosure in the position shown and secure with (2) #6 thread form screws.

Make sure to orient the board with the D12 and D13 terminals to the right as indicated by the yellow arrows.

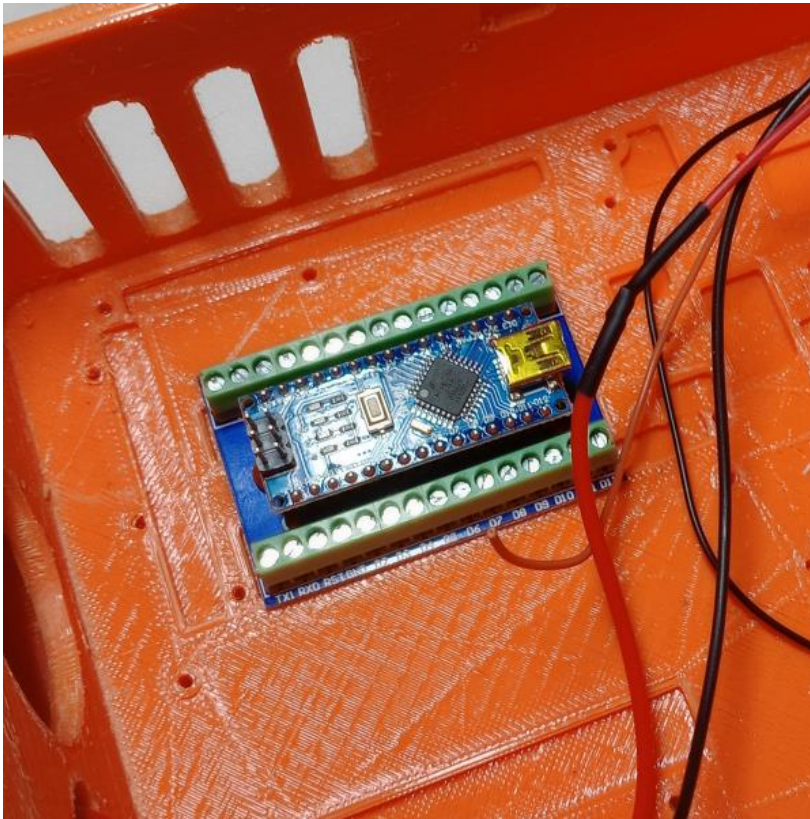

Insert Nano board into terminal breakout board as shown.

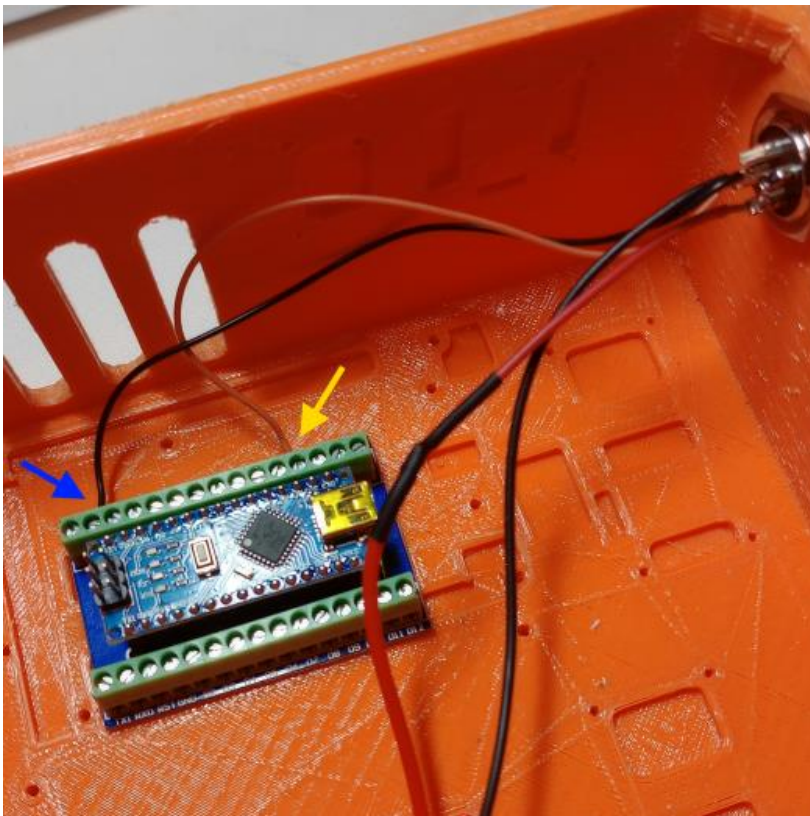

Connect the orange wire to the A0 terminal.

Connect the black wire to the GND terminal.

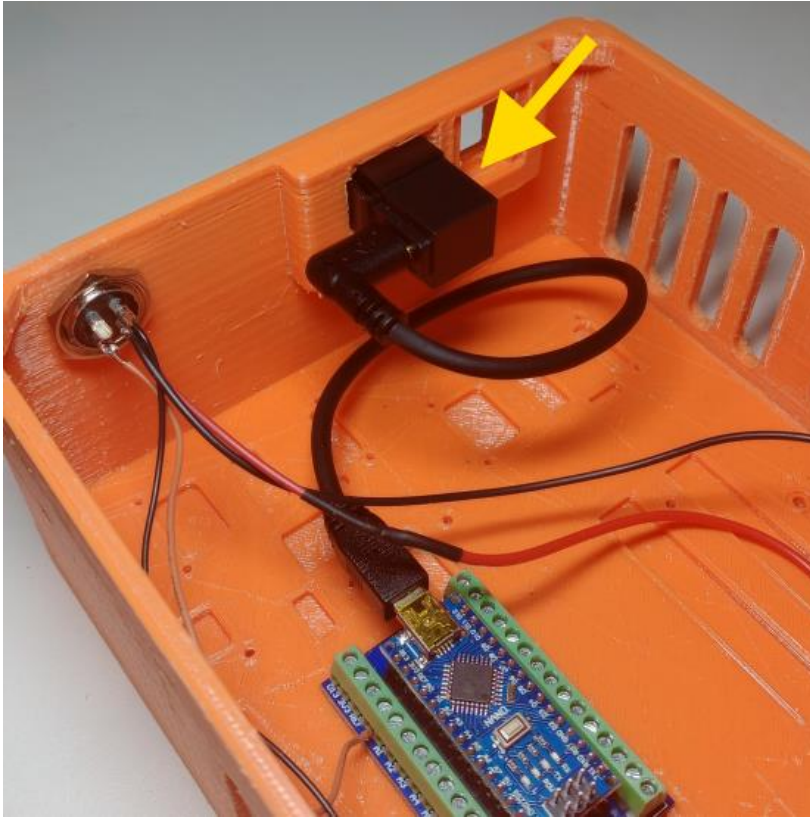

Install USB keystone jack into enclosure as shown, then connect USB cable from keystone jack to Nano board.

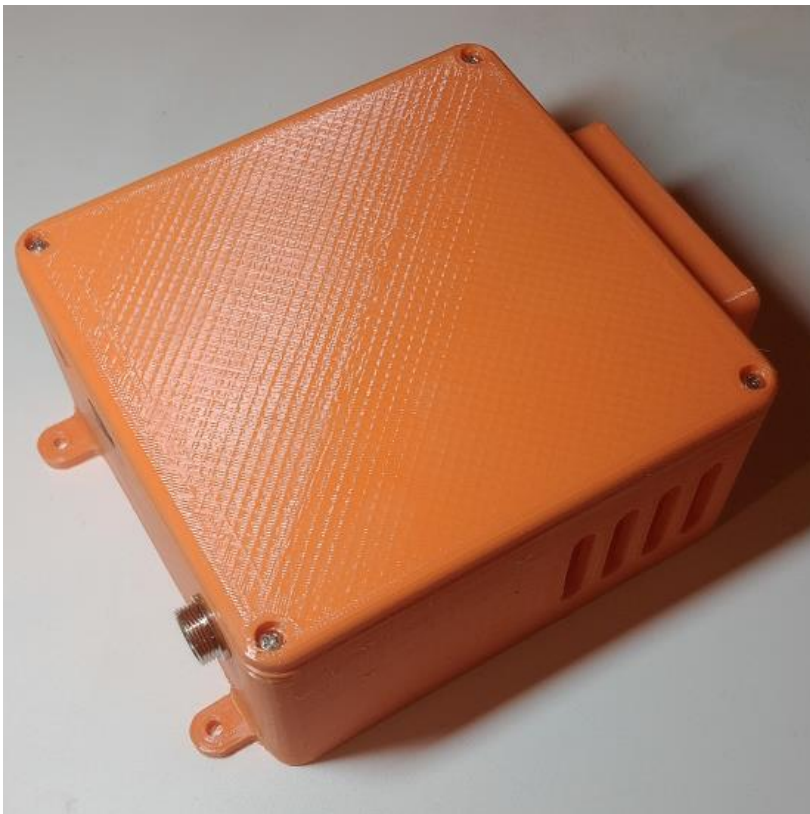

Install auxiliary enclosure lid and secure with (4) #6 thread form screws.

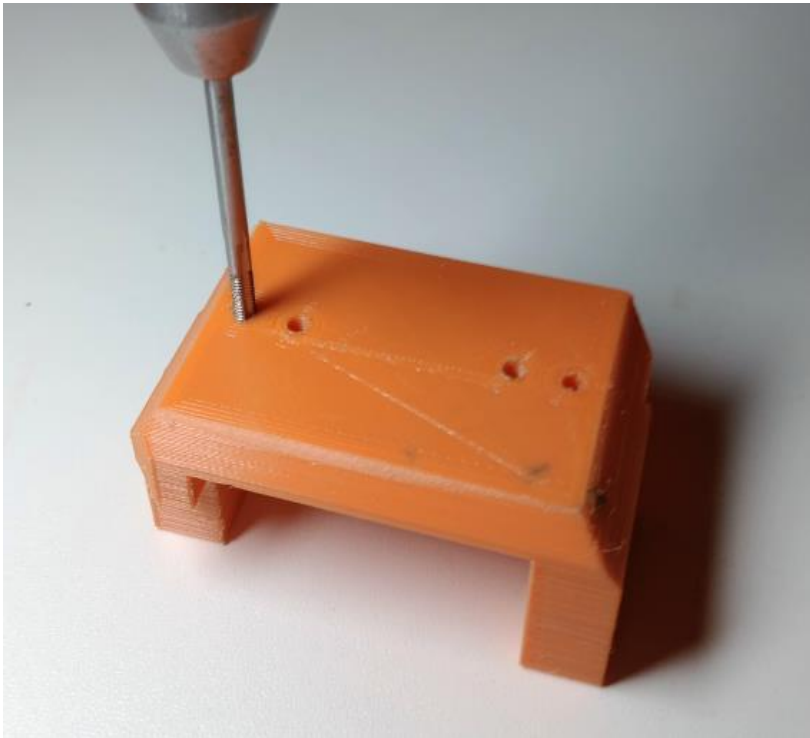

Tap the (4) bottom holes on the gripper base with M3 tap.

Apply light oil and tap hole slowly by hand, do not attempt to power tap with drill.

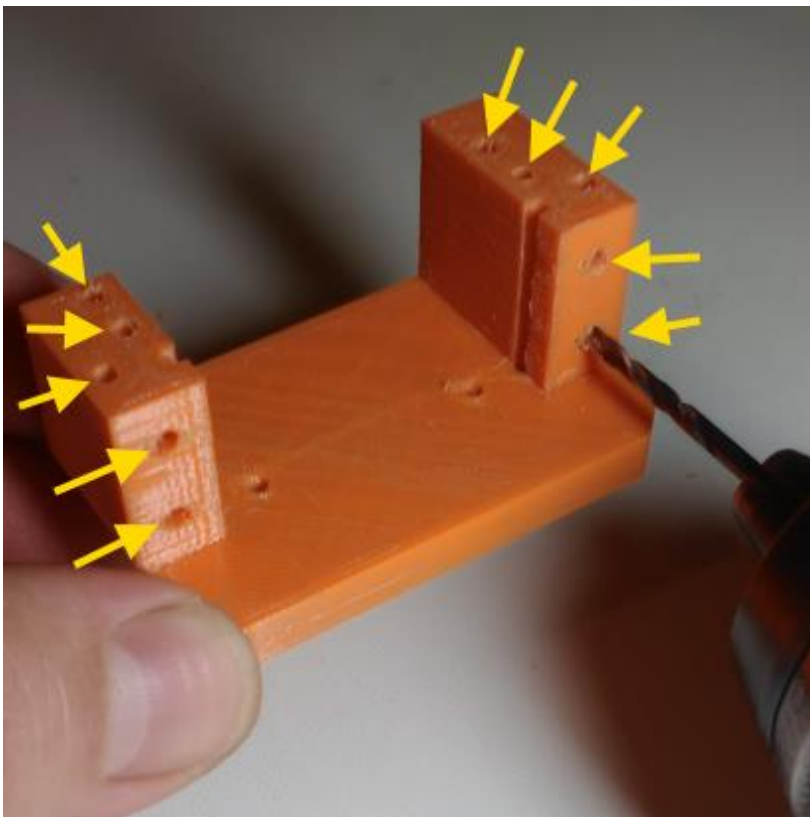

Use 2.5mm drill bit to clear out each of the 10 holes shown in photo.

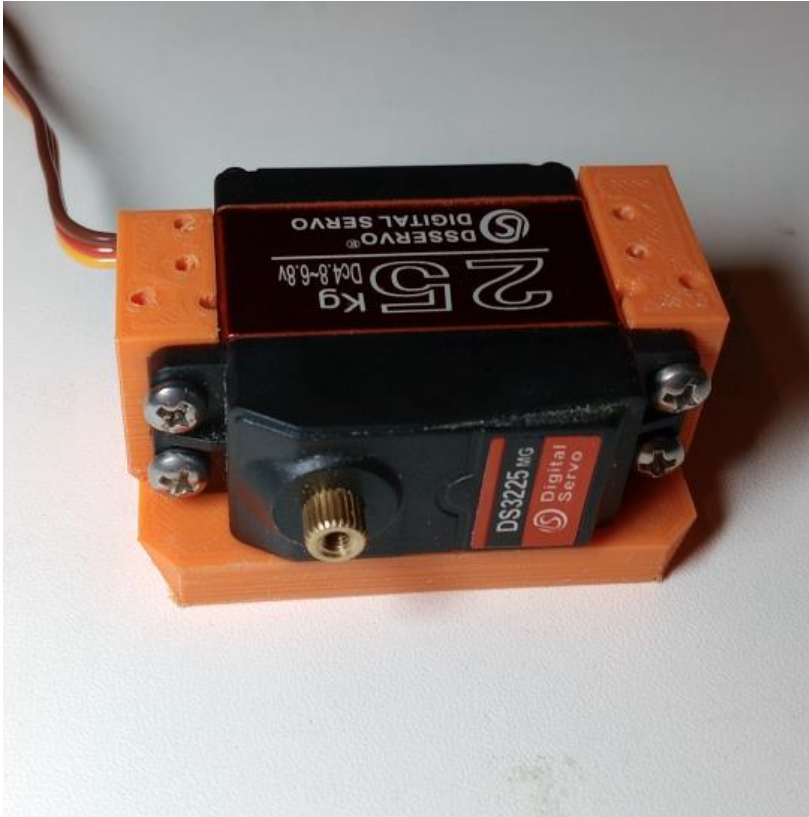

Secure servo to base assembly as shown and secure with (4) #6 screws

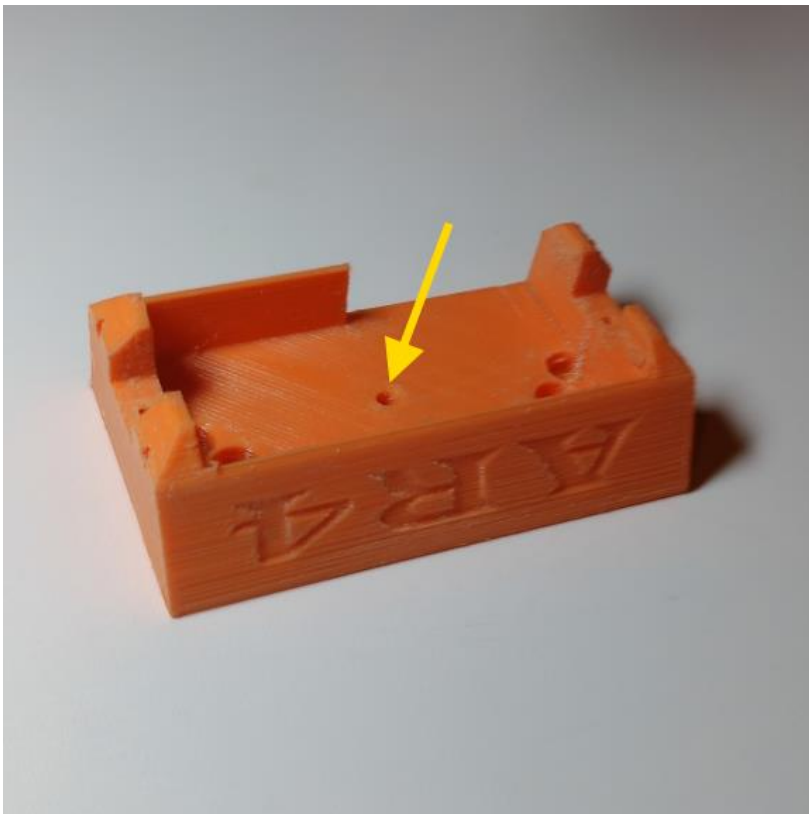

Use 3mm drill bit to clear center hole in 3D printed carriage.



Place small drop of super glue on end of 16.5mm long shaft

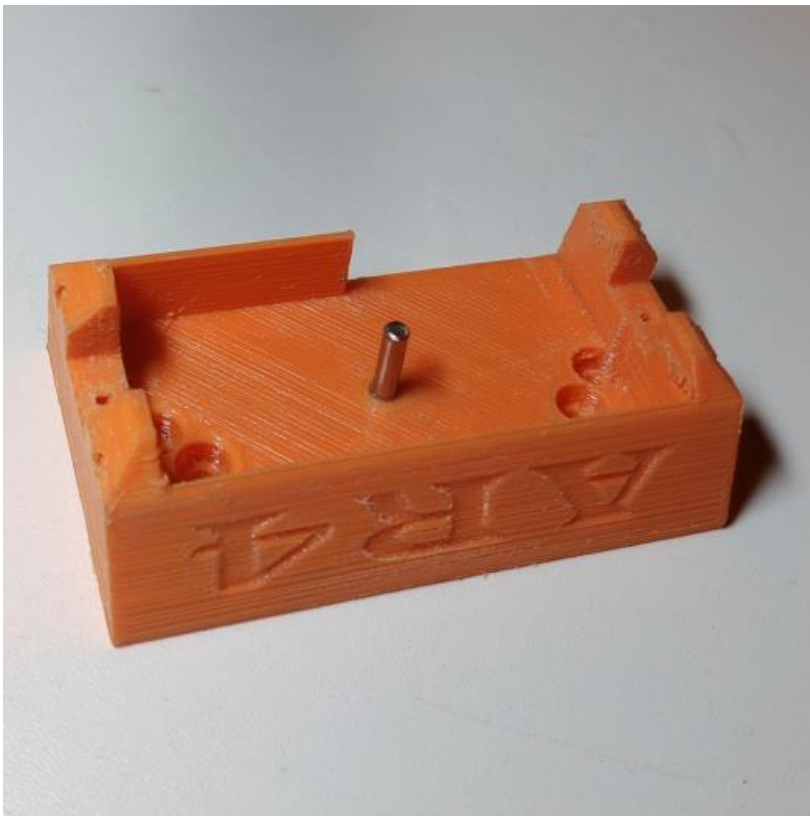

Insert glued end into carriage center hole and tap down into place. Shaft need to be fully inserted flush to bottom surface of carriage.

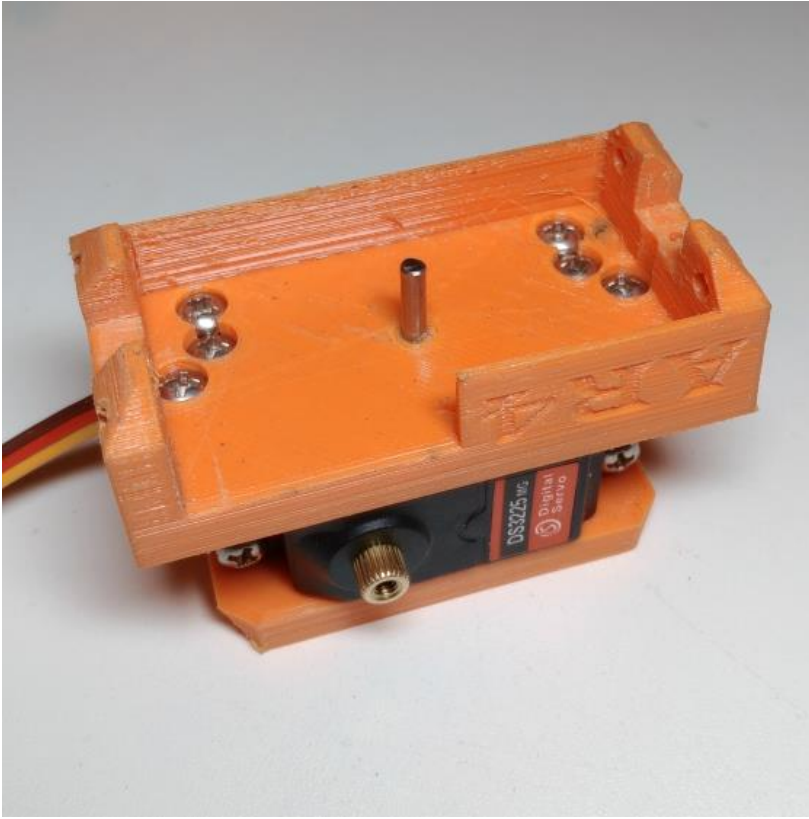

Secure carriage to base as shown with (6) #6 screws.



Use 3.1mm drill bit to clear center hole in 3D printed gear.



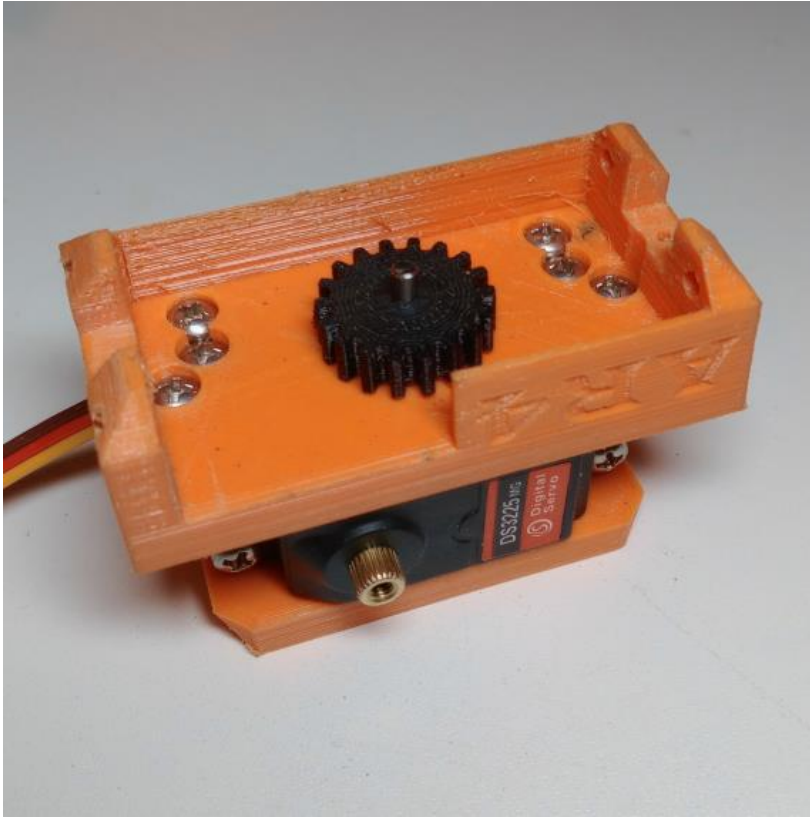

Install gear on center post and make sure it spins freely.

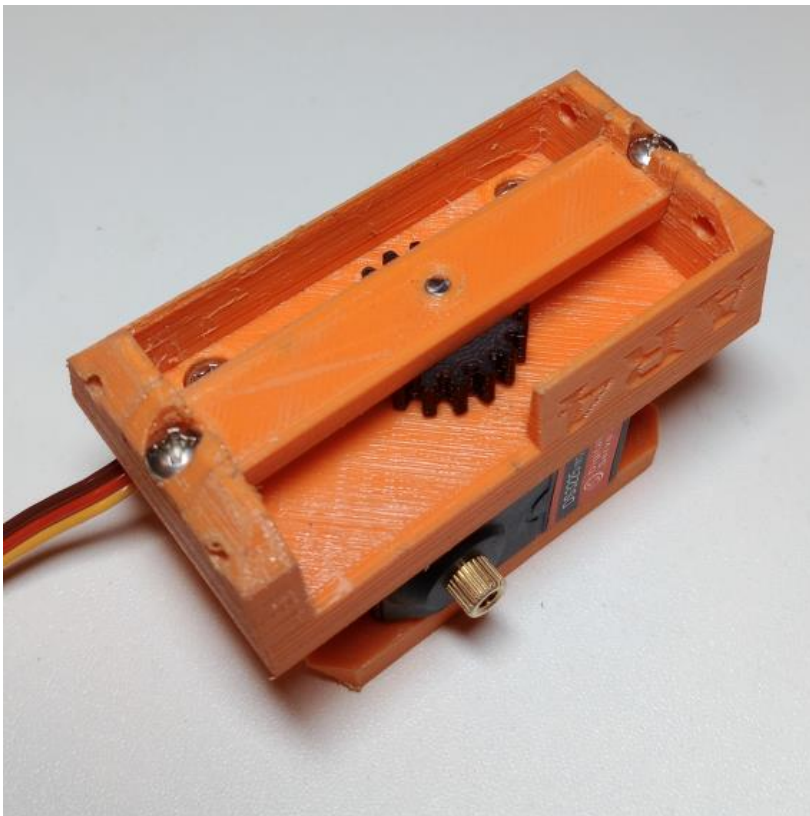

Install center bar and secure with (2) #3 screws as shown.



Use 3.1mm drill bit to clear both rail holes in the 3D printed jaw1 and jaw2 parts.

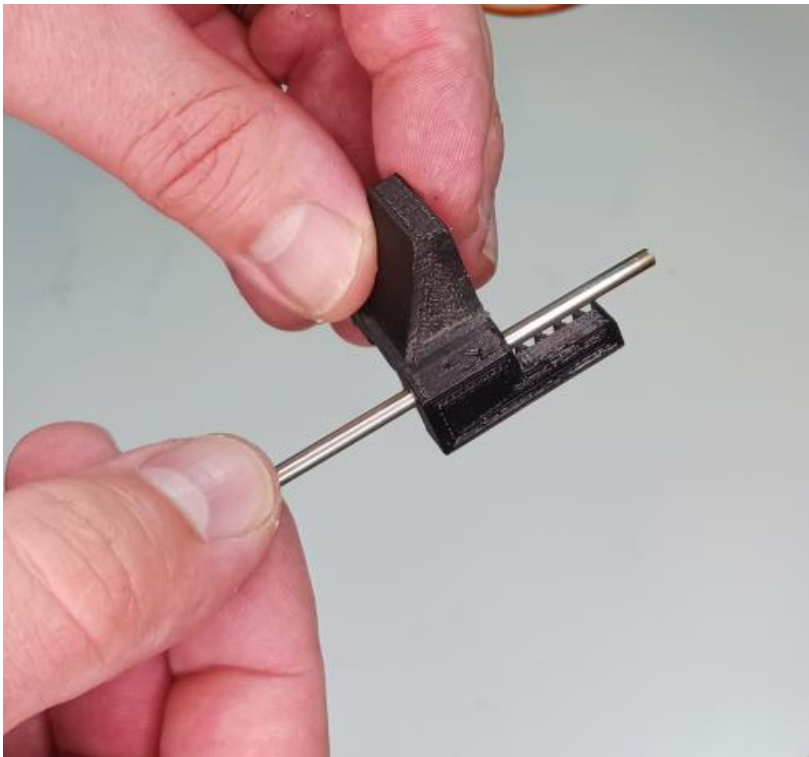

Make sure 3mm rod slides easily in each jaw rail hole.



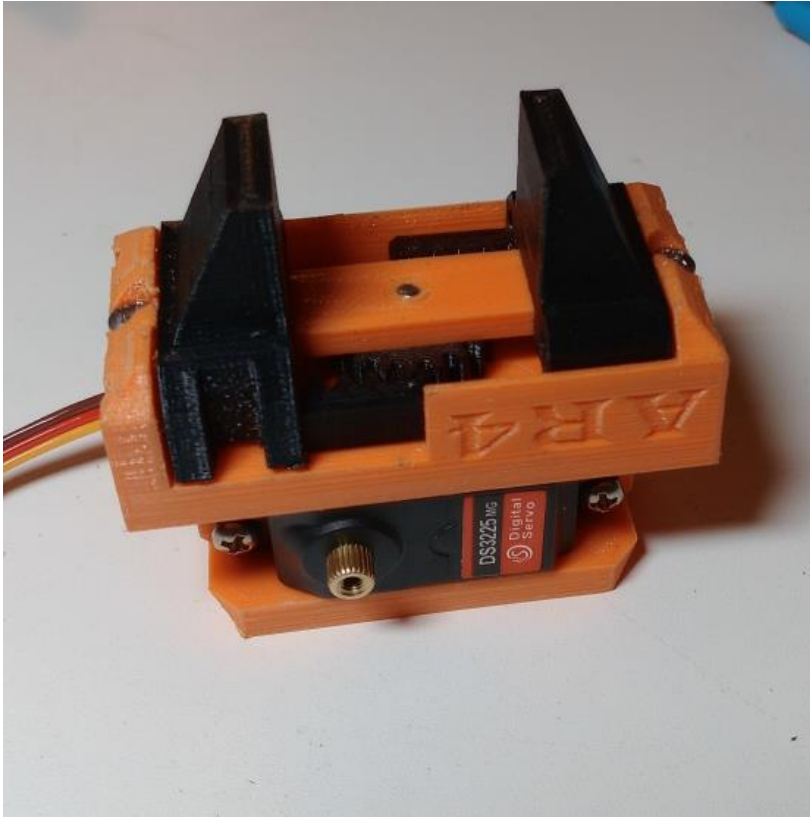

Install jaw1 and jaw2 as shown. Make sure the jaws slide easily.

Make sure to clean all 3D printed parts, remove any positives or imperfections, use flat file and square file to carefully clean or polish all flat surfaces and make sure all parts move and slide freely.

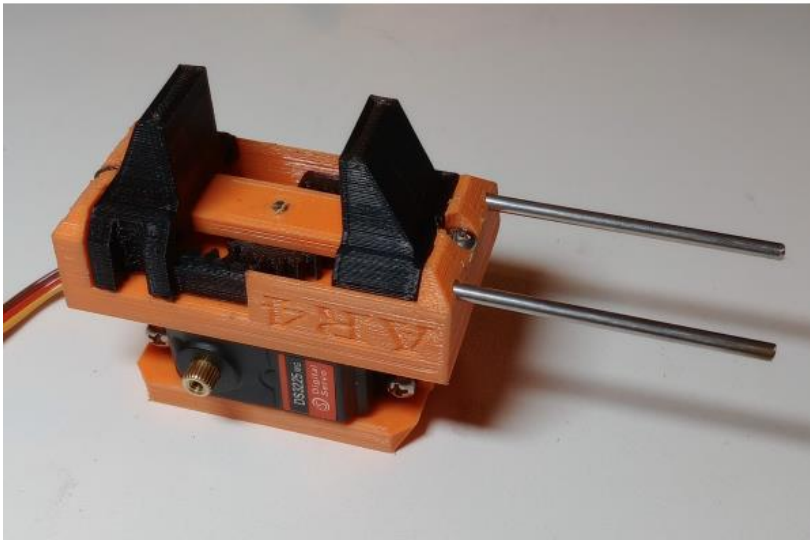

Use 3mm drill to clear end holes in carriage and then insert the (2) 70mm rods through carriage and through jaw rail holes as shown.



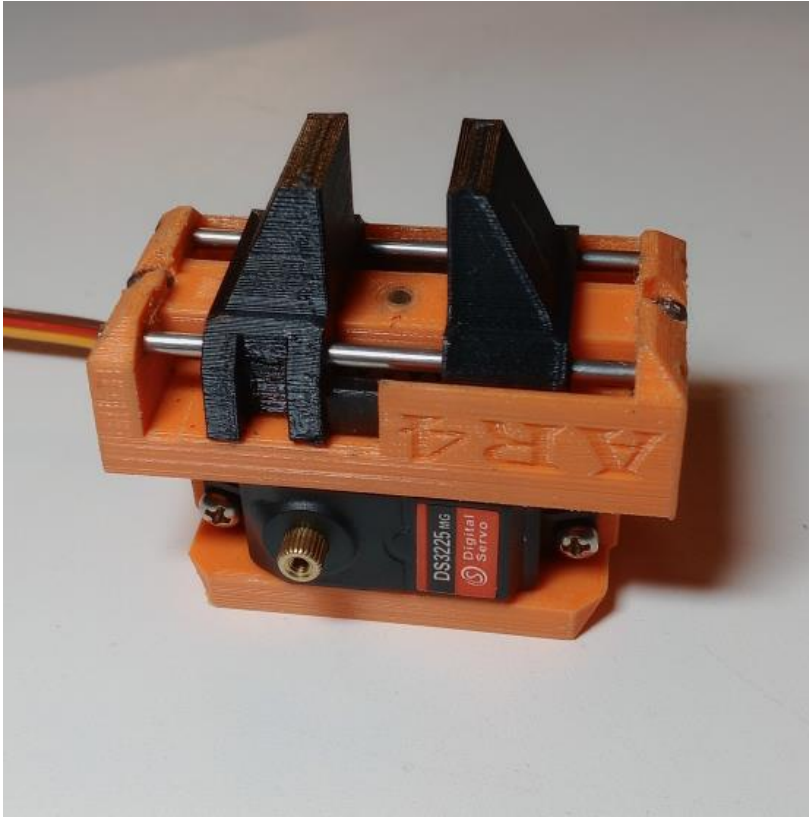

Finish inserting rods through the other jaw and into other side of carriage.

Make sure jaws slide easily.

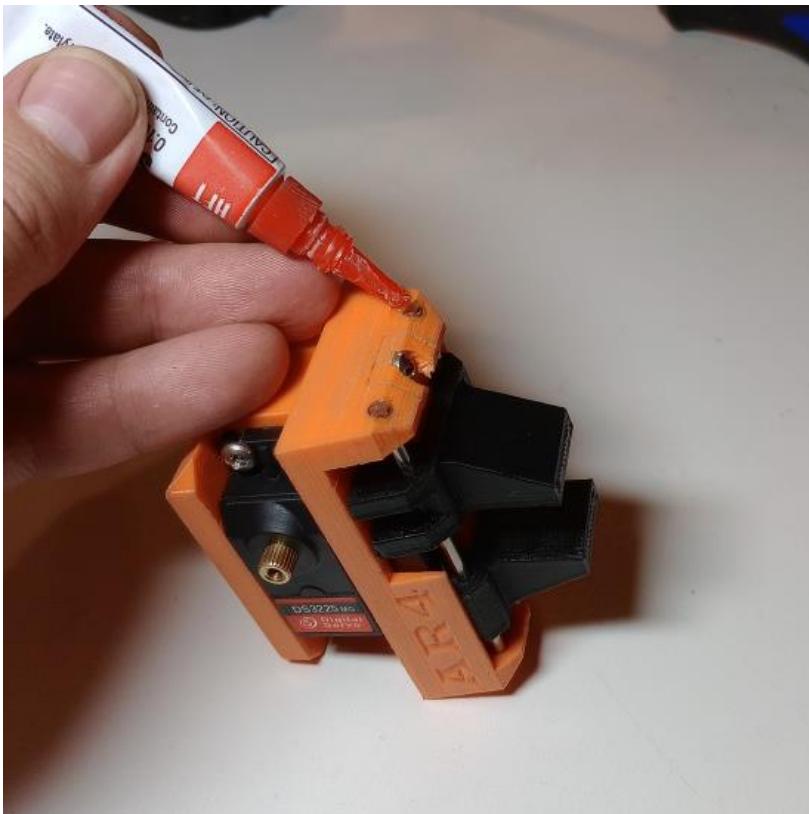

Place drop of super glue at each end of both rods to secure rods in place.

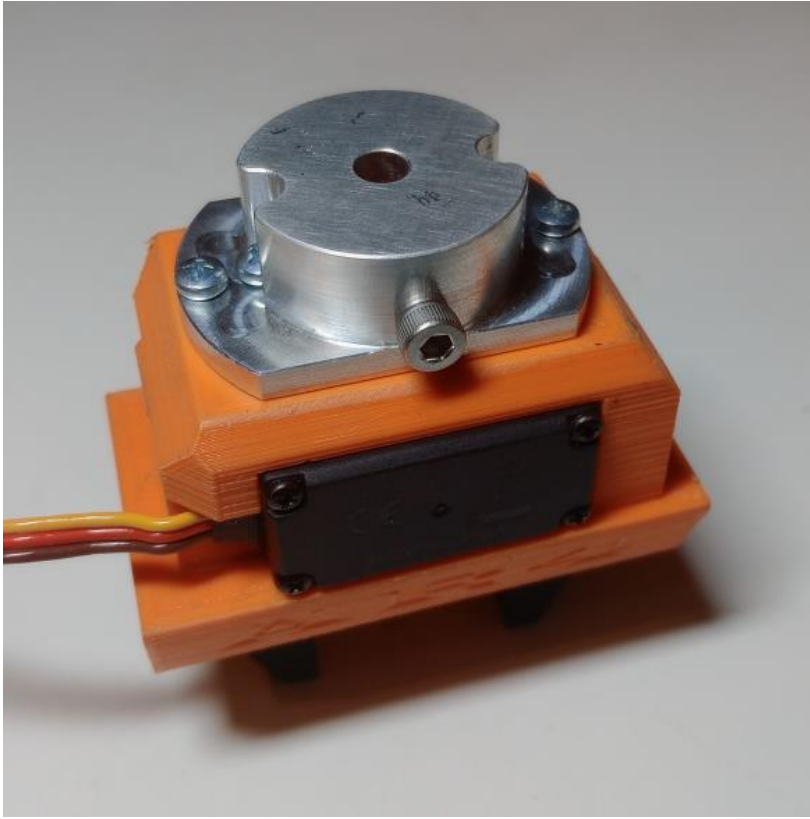

Install J6 gripper mount onto gripper assembly as shown and secure with (4) M3x10 pan head screws.

Make sure the gripper mount M4 cap screw is facing the back of the servo when installed.

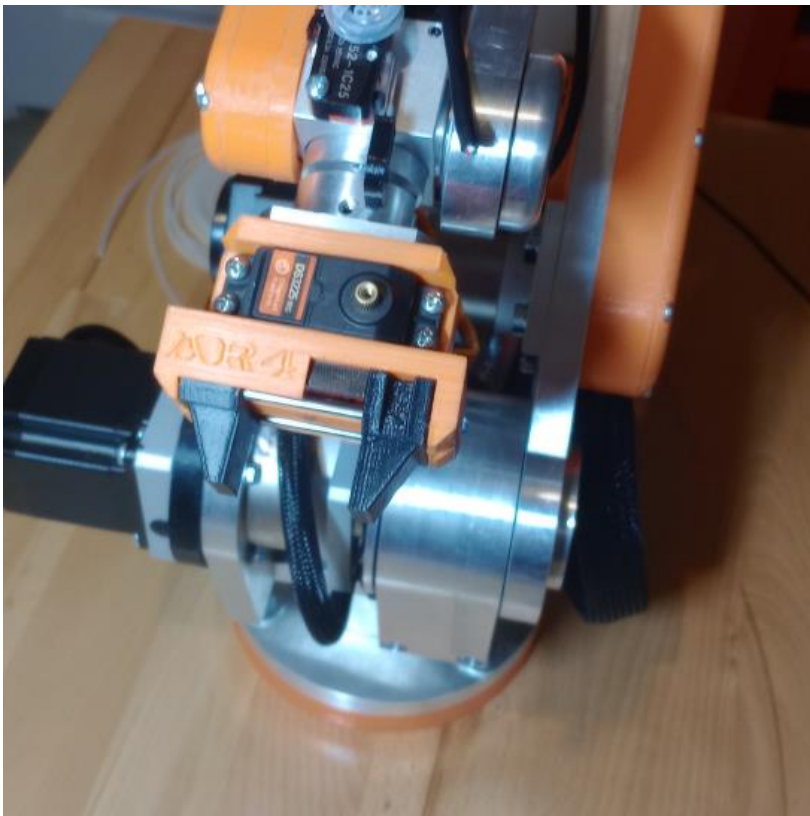

Install gripper on robot.

Timing screw head should be facing down and set screw should be facing up as shown in photo.

NOTE: do not install servo armature yet, this will be done in a future step.

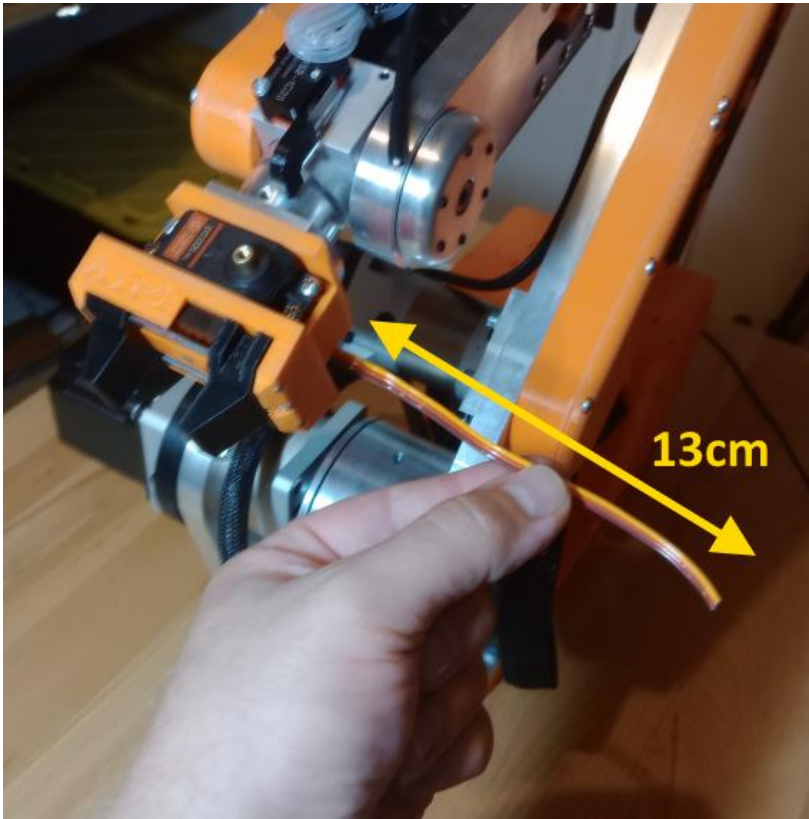

Trim the servo wire to a length of 13cm as shown.

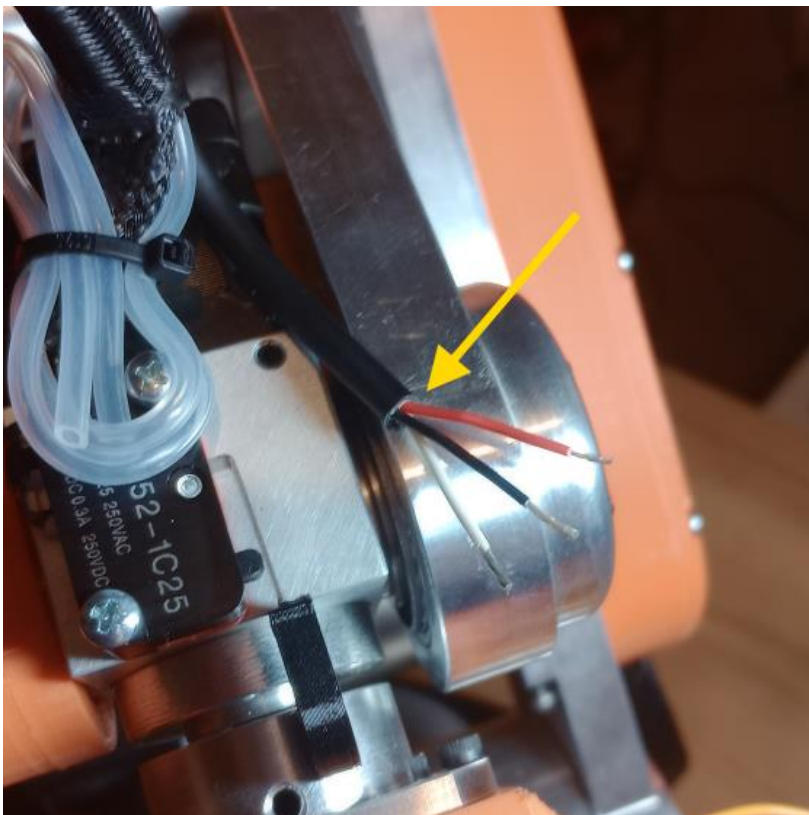

Remove 3cm of jacket from the 3 conductor gripper cable installed on robot.

Then strip wire ends as shown in photo.



Strip wire ends of servo as shown.

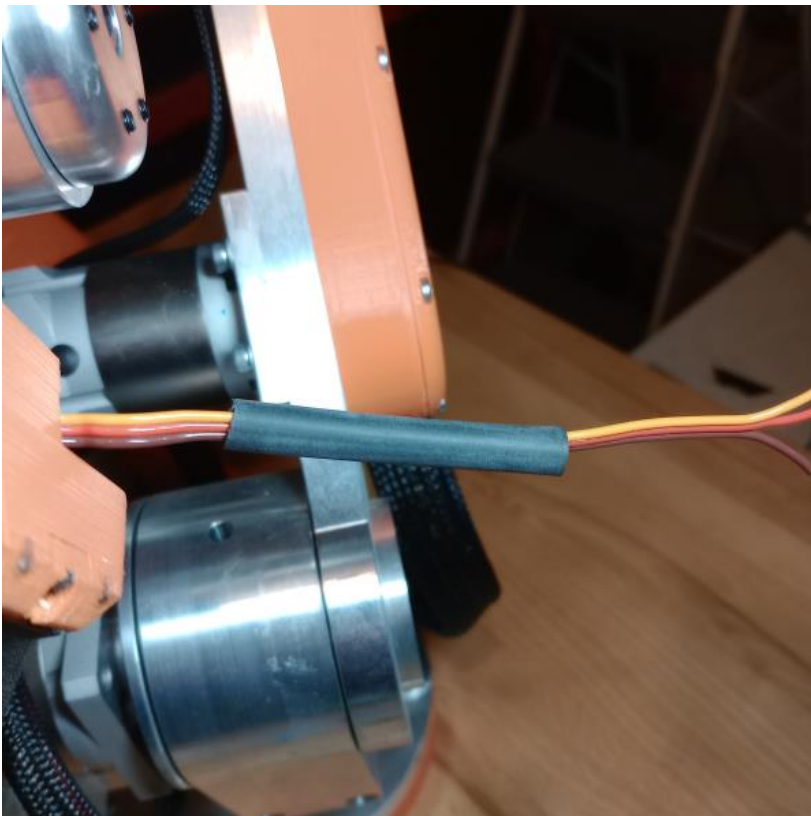

Slide a 6cm long length of larger 6mm heat shrink tube over the servo wires.

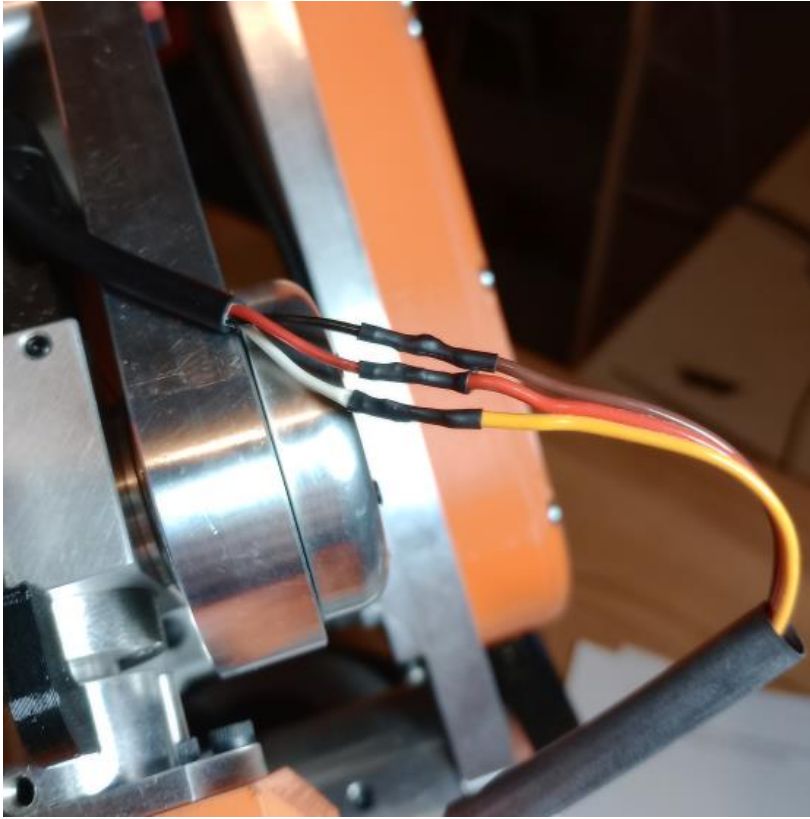

Solder and heat shrink the servo wires to the robot 3 conductor gripper cable as follows:

- Servo brown wire to cable black wire.
- Servo orange wire to cable red wire.
- Servo yellow wire to cable white wire

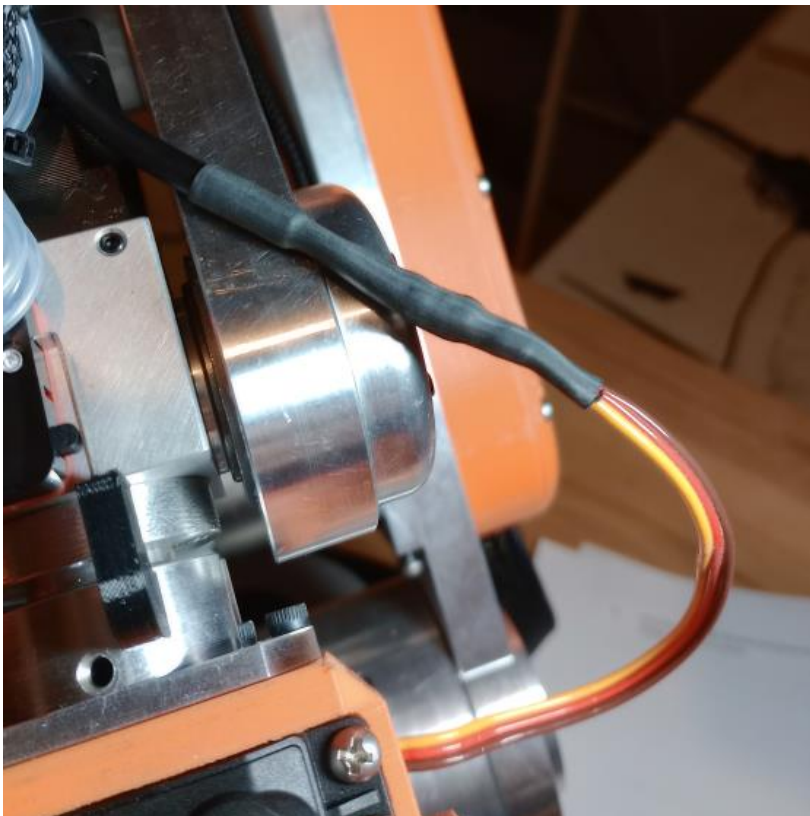

Slide the larger heat shrink tube up over the transition between the cable and the servo wire and shrink tubing as shown in photo.



Remove 1.5cm of the jacket from each end of the remaining 175cm long 4 conductor cable.

Next strip the end of each individual wire as shown.

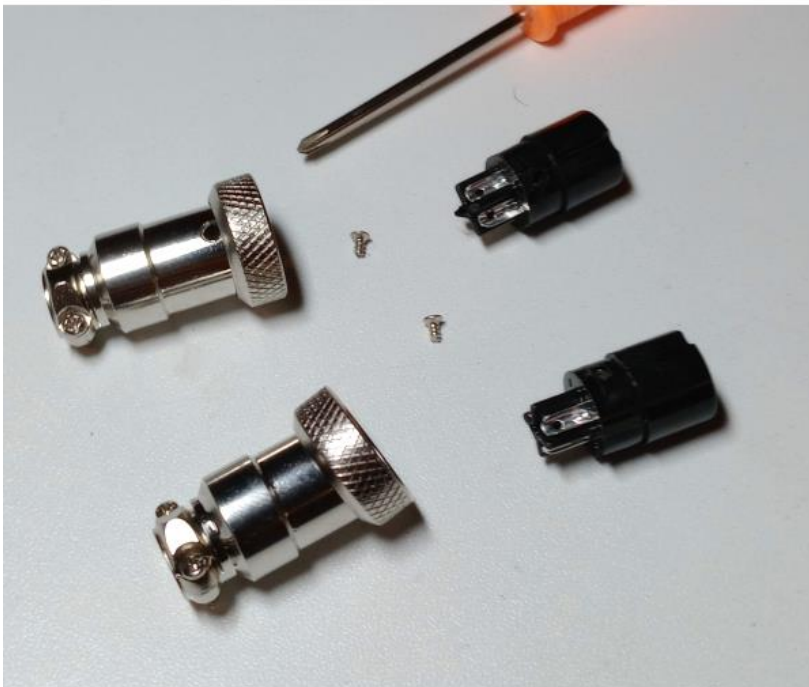

Remove the screw and cover from (2) female GX16-4 connectors.



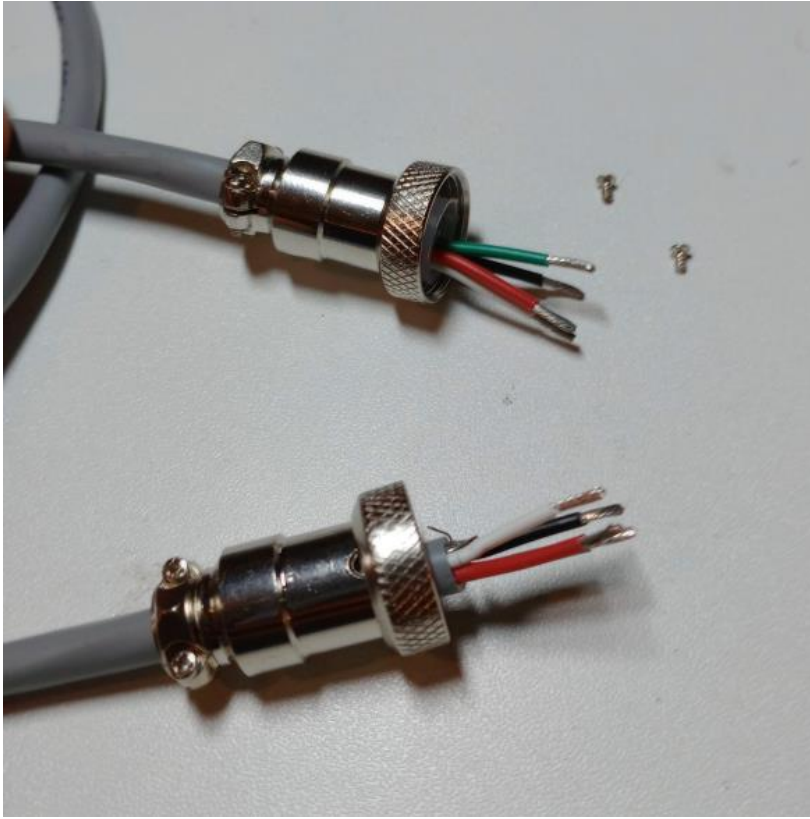

Slide GX16 connector covers over the ends of the cable as shown.



Solder the cable wire to the GX16 terminals as follows:

#1 – BLACK

#2 – RED

#3 – WHITE

#4 – GREEN

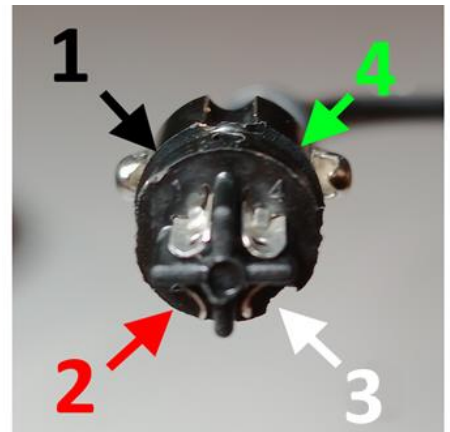



Reinstall connector cover,
install retaining screw and
tighten the cable clamp.



Repeat the last 2 steps for
the other end of the cable.



Plug one end of cable into robot base.

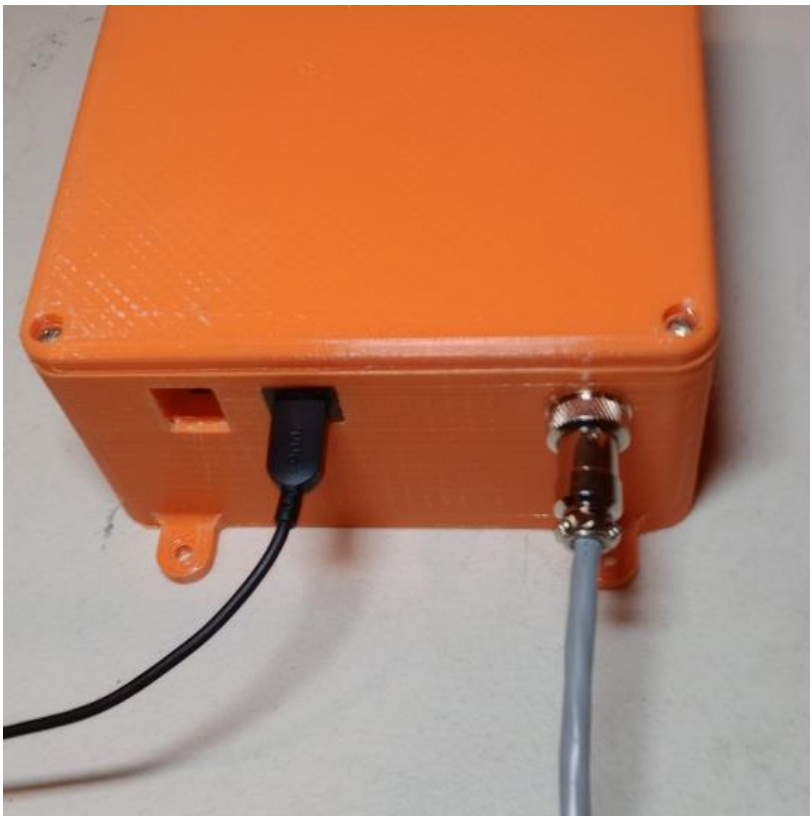

Plug other end of cable into auxiliary enclosure.

Plug USB cable into your PC.



Plug 5vdc adapter into AC socket



Plug 5vdc adapter into auxiliary enclosure.

Open the Arduino software, from the tools, AVR boards menu select the Arduino Nano.

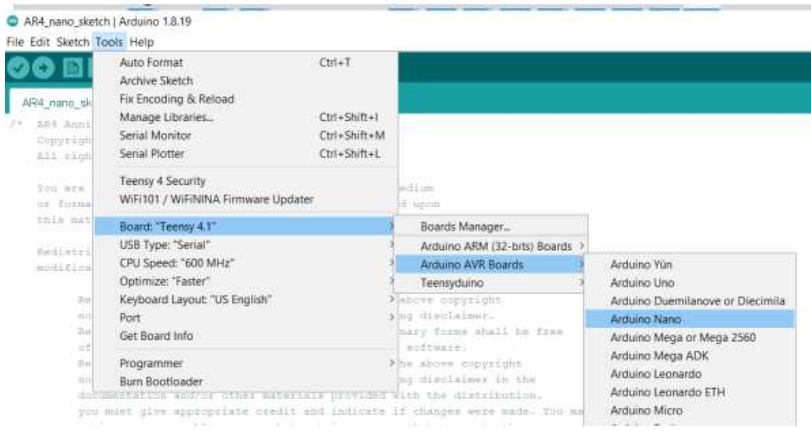

From the tools, processor menu select the (old bootloader) option.

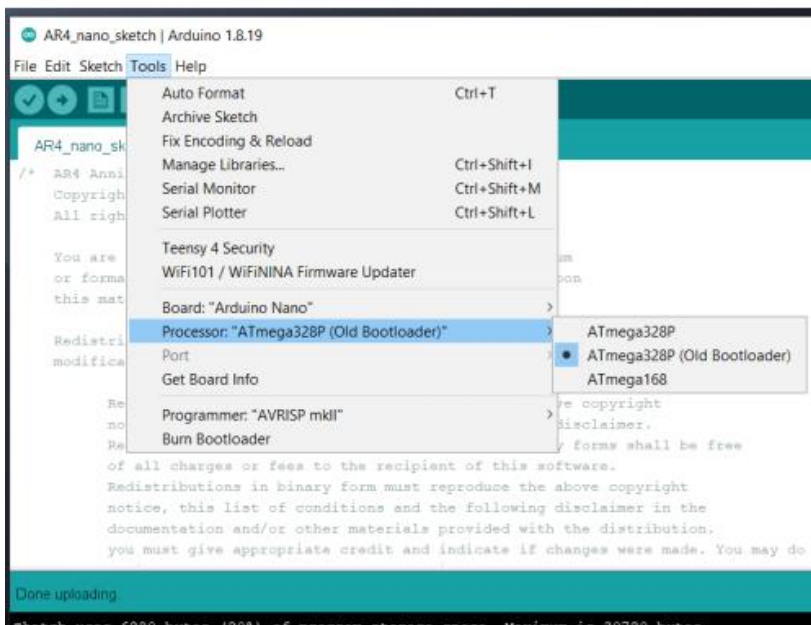

The standard ATmega328 option may work but I have had better luck on most boards with the old bootloader.

Device Manager

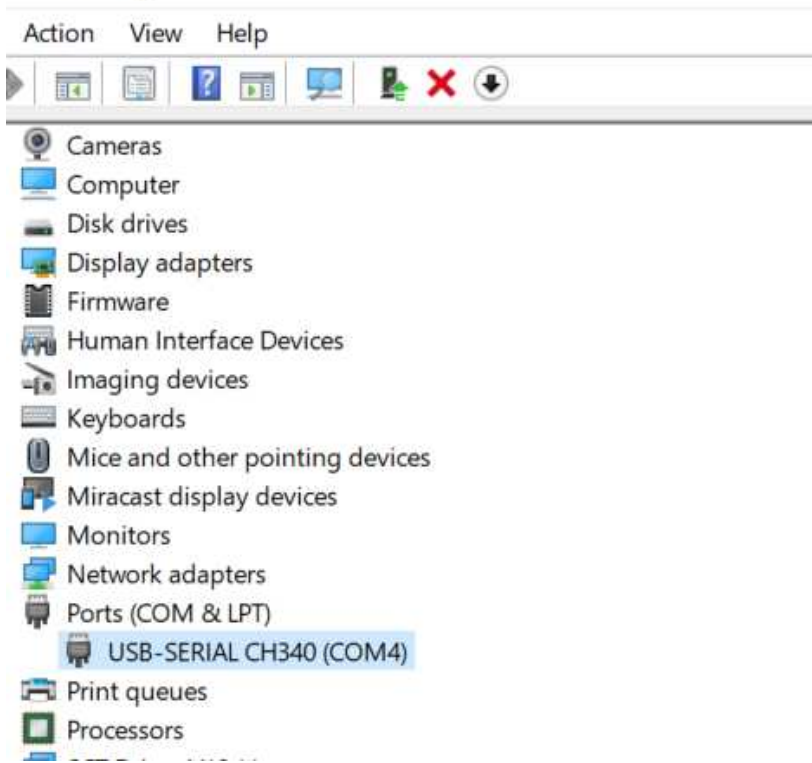

Open your device manager and double check which COM port your nano board connected to. In my case it's the only COM device plugged in at the moment so I know its COM4 but you can unplug and plug it back in and see which COM port updates on the list.

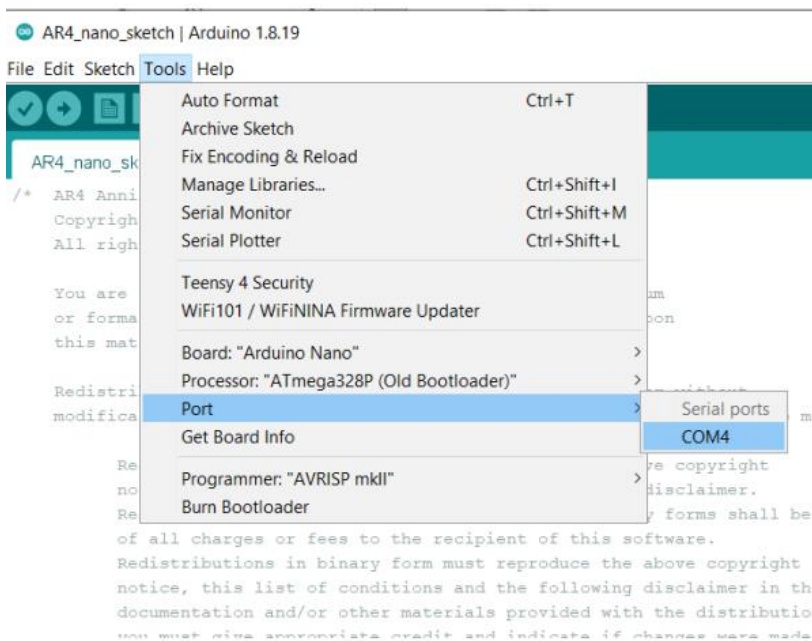

Double check from the tools, port menu that its set to the same COM as your device manager. In my case its COM4.

NOTE: In the AR4 software you will also want to set your Nano COM to this com port.

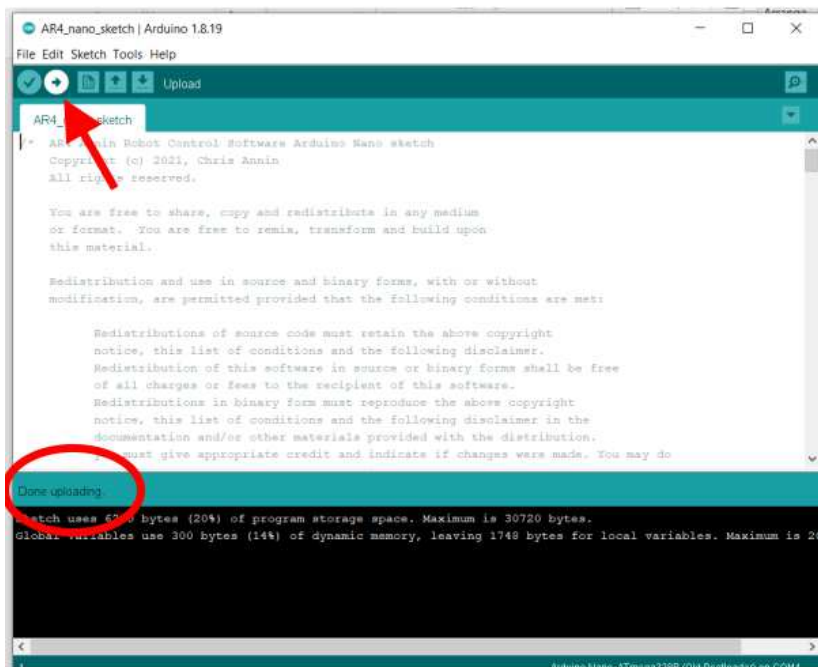

Press the upload sketch button to load the program to the Nano board. It should say done uploading when complete.

AR4 Software Ver 3.3

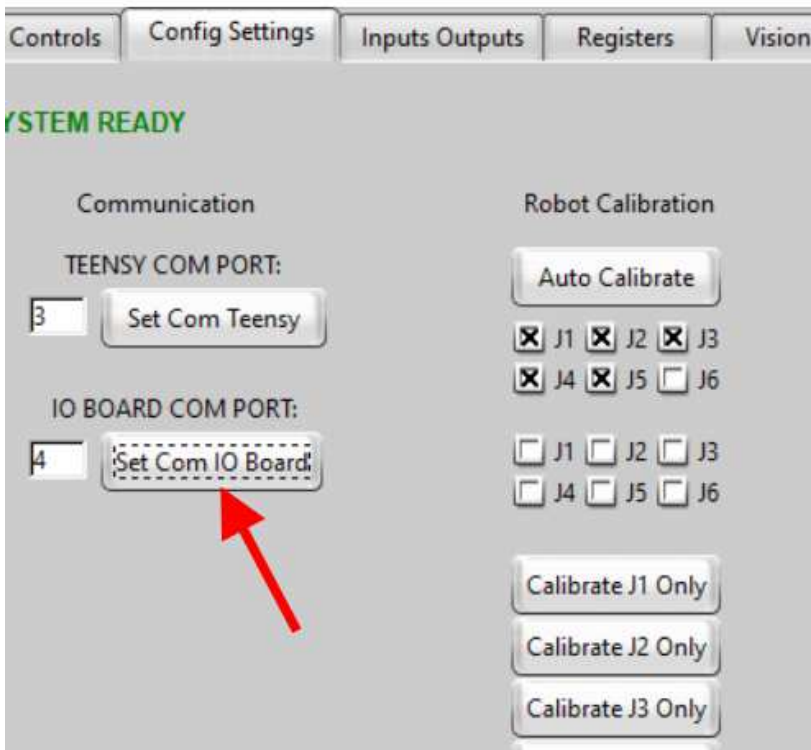

Open the AR4 software, from the config settings tab set the COM port as noted in previous steps to the correct number and then press the Set Com IO Board button.

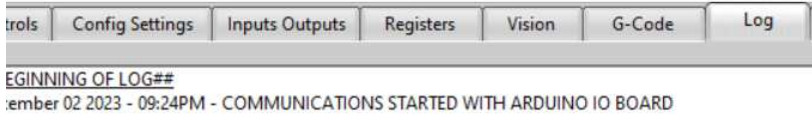

In the software log file it should say communications started with IO board.

AR4 Software Ver 3.3

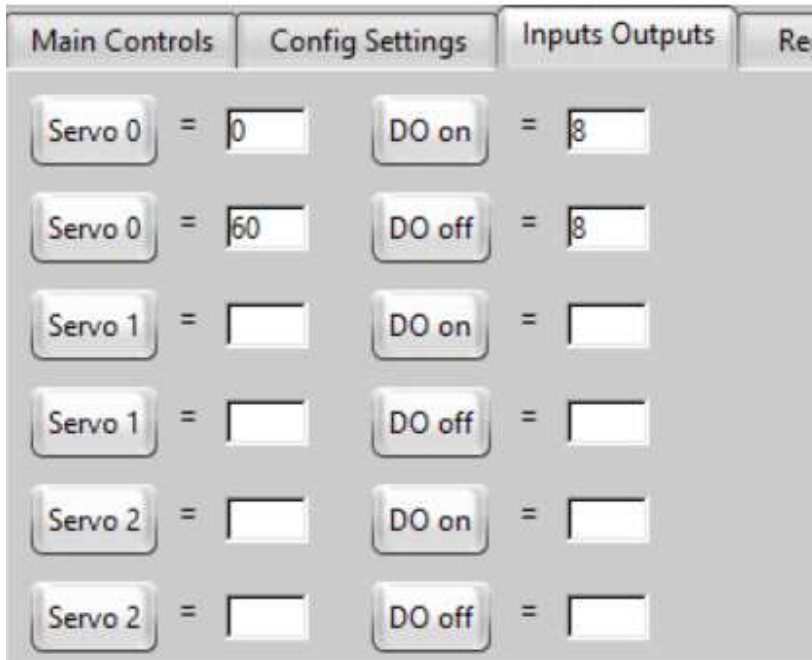

On the input output tab set the first Servo 0 field to "0" and set the second field to "60"

Press each Servo 0 button and you should hear and see the servo spindle rotate from its 0 position to the 60 degree position

NOTE: In these instructions the servo is wired to nano input A0 but if you want multiple servos or want to use a different input you can for example use input A1 and that would be servo 1 in the AR4 software.



Main Controls	Config Settings	Inputs	Outputs	Registers
Servo 0	= 15	DO on	= 8	
Servo 0	=	DO off	= 8	
Servo 1	=	DO on	=	
Servo 1	=	DO off	=	
Servo 2	=	DO on	=	
Servo 2	=	DO off	=	
Servo 3	=	DO on	=	
Servo 3	=	DO off	=	

We need to install the servo gripper arm while the servo motor is in the correct position.

So that the gripper is applying adequate pressure in the fully closed position set the servo to a value of 15.



Install M3x5 Socket Head Cap screw in Servo arm as shown.



Close the gripper jaws by hand and then install the servo armature as shown while the servo is set to 15.

Be sure to tighten arm clamp screw on side and front retention screw.

Now you should be able to press the servo button at 0 and 60 to fully open and close the gripper.

NOTE: the servo is capable of rotating from 0 to 180 but this gripper only needs 60 degrees to fully open.

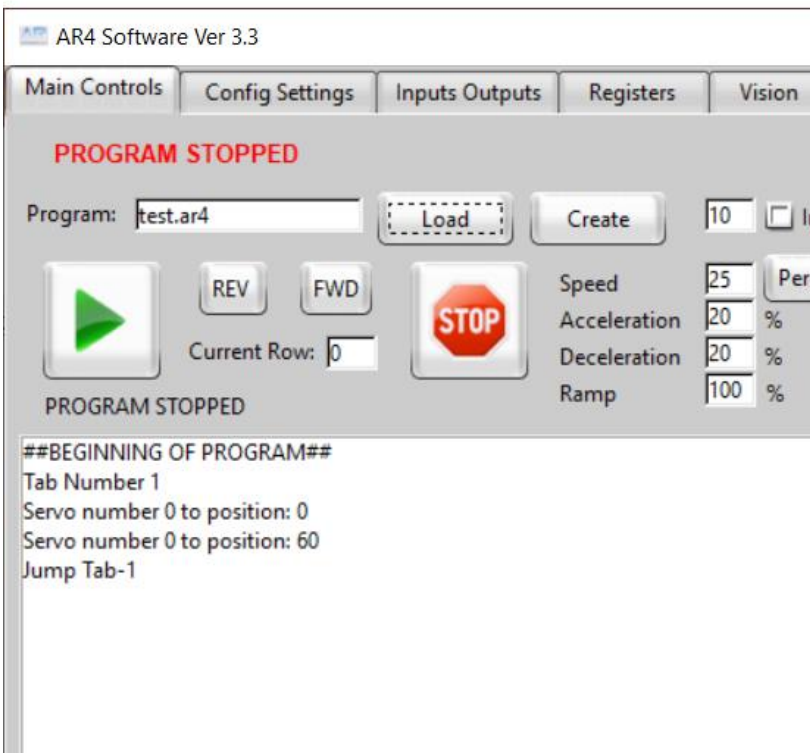

NOTE: you can create a test program as shown with the commands:

Tab Number 1

Servo number 0 to pos 0

Servo number 0 to pos 60

Jump Tab-1

To create a program that loops and opens on closes the gripper over and over.

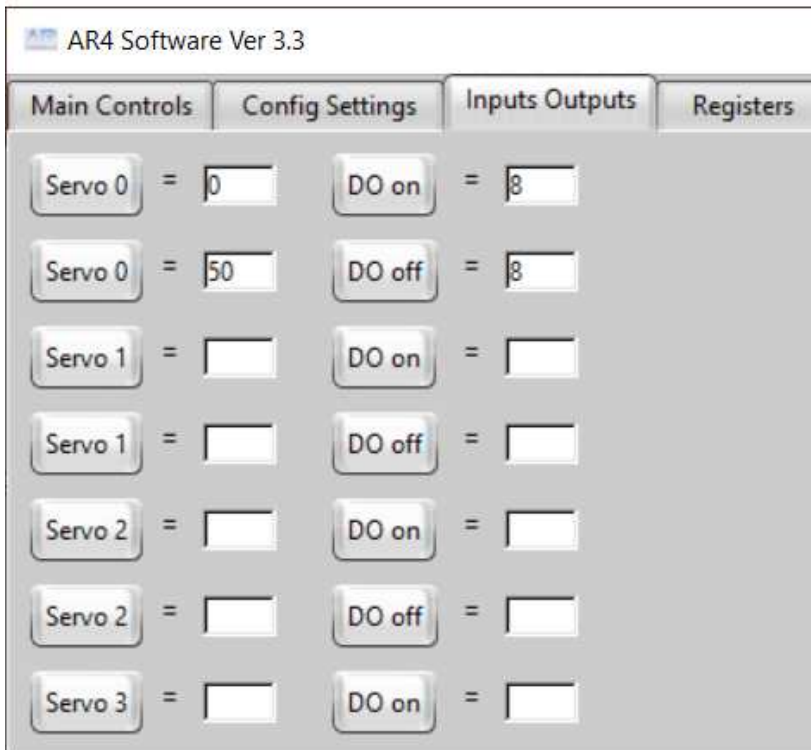

When gripping a part, or with the servo at 0 or 60 it is trying to apply force either against the part or force fully closed or fully open. When the servo is applying force it will start to heat up and if left in a grip position for too long its possible to overheat the servo. **It is best to set the servo value to 50 when not in use** – this way the servo is very close to its fully open position but its not under load trying to fully open or close.

DO NOT LEAVE THE UNDER LOAD FOR MORE THAT 20 TO 30 SECONDS AT A TIME.

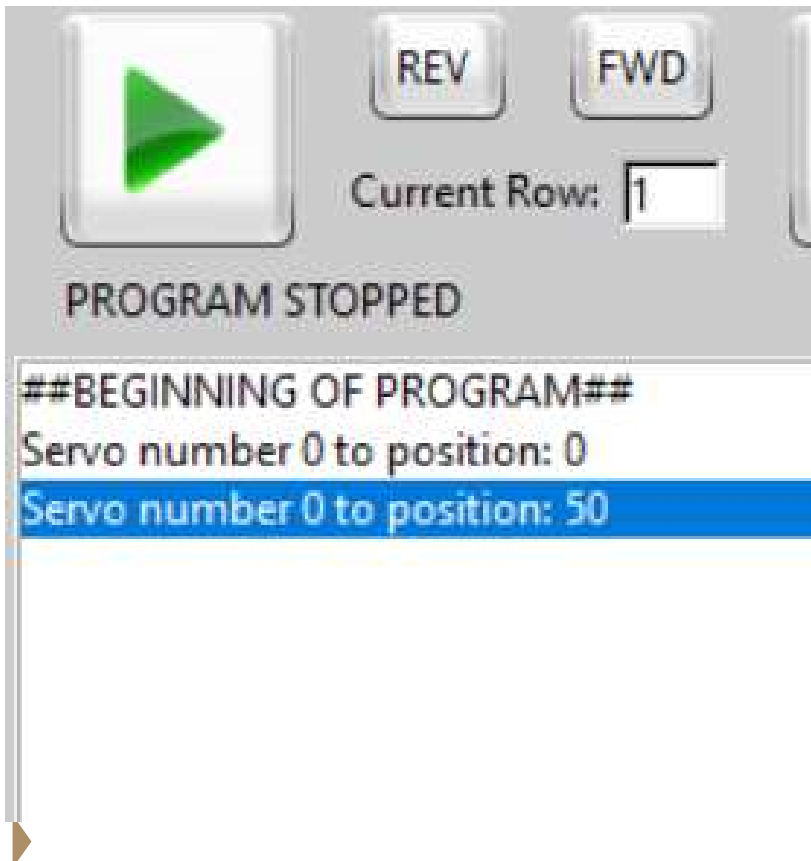

You can control the servo gripper in the robot program using the lines of code shown generated from the “Servo” command button.

REFERENCE:

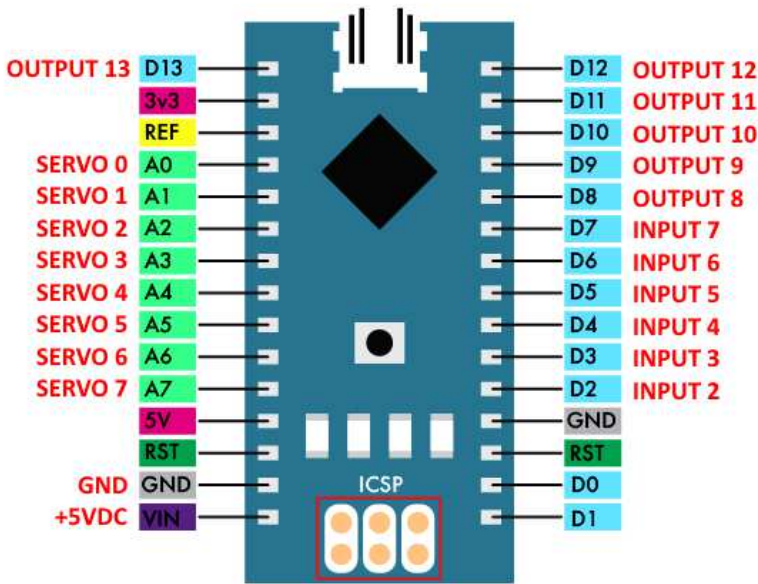

The Nano sketch file for the AR4 robot allocates the servo and input / outputs indicated in red text in the diagram shown.

Using the Nano you can control up to 8 servos, 8 digital outputs and monitor up to 8 inputs.

Note the Arduino Mega board can also be used if additional IO is required for your project.

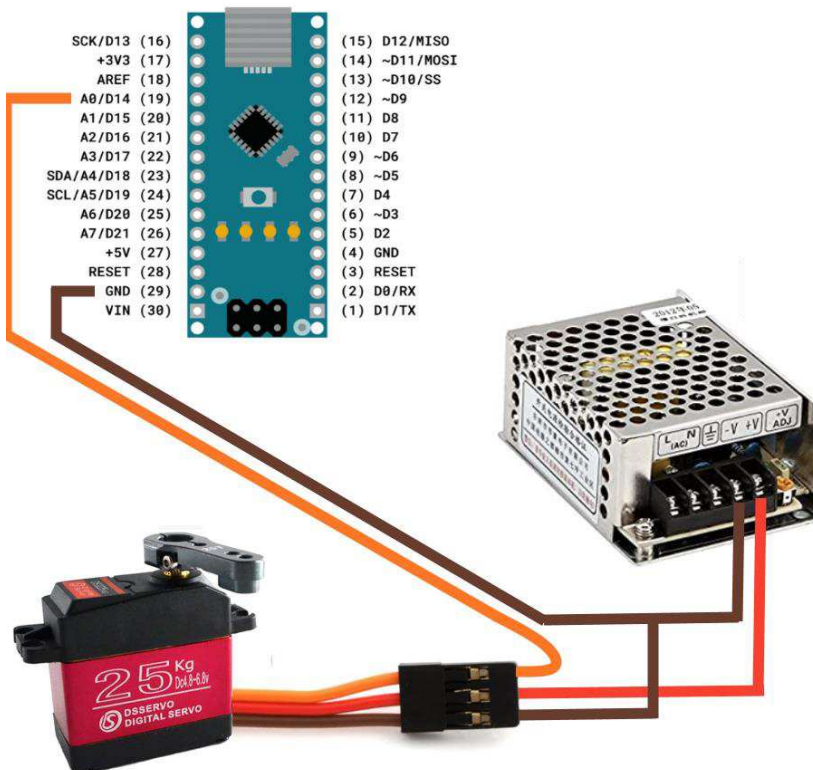

REFERENCE:

This is a high level wiring diagram to help visualize the servo wiring.

The servo should be wired as shown. Note the power supply -5v is shared with the Arduino -5v or GND terminal.

Please see this video for more information on servo wiring.

<https://youtu.be/76F6dS4ar8Y>

CHAPTER 6

ADDITIONAL AXIS

The AR4 robot has the capability of controlling up to 3 additional axis (7th, 8th and 9th axis). The most common additional axis is a 7th axis travel track which will be covered in the chapter. Other uses for an additional axis are applications such as having the robot control the focus and aperture on a camera, having the robot control a turn table or part rotation device or having the robot control a stepper motor controlled gripper.

This chapter will illustrate the installation of drivers and wiring for a 7th and 8th axis. An additional drive for a 9th axis can be installed following the same directions but is not shown. Additionally this chapter shows the construction of the a 7th axis travel track using 500mm length guides but you can build the track any length you want. Track can be screw drive as shown or you can design your own track or use a belt drive if desired.

Any stepper motor can be used that meets the amperage requirements of the DM332 or DM320T drivers shown



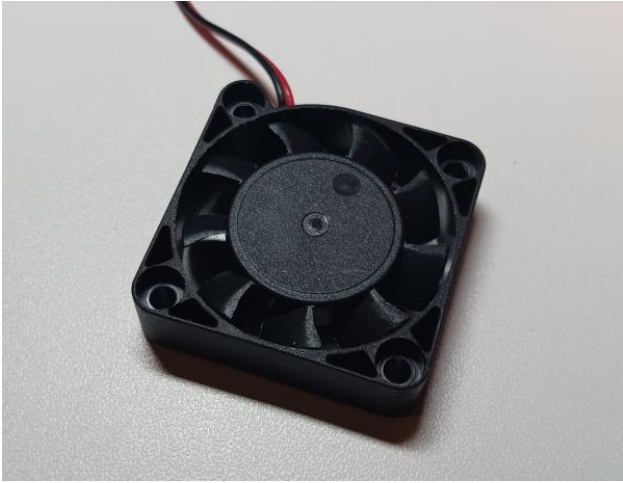

40mm 24vdc brushless cooling fan.



5.5mm DC power jack socket.



30cm length of CAT5 cable





Auxiliary enclosure

-

The 3D print file for this part can be found along with the robot print files on the downloads page.



Auxiliary enclosure lid

-

The 3D print file for this part can be found along with the robot print files on the downloads page.



J1 Base enclosure fan cover

-

This is the same 3D printed part that is used on the robot base.



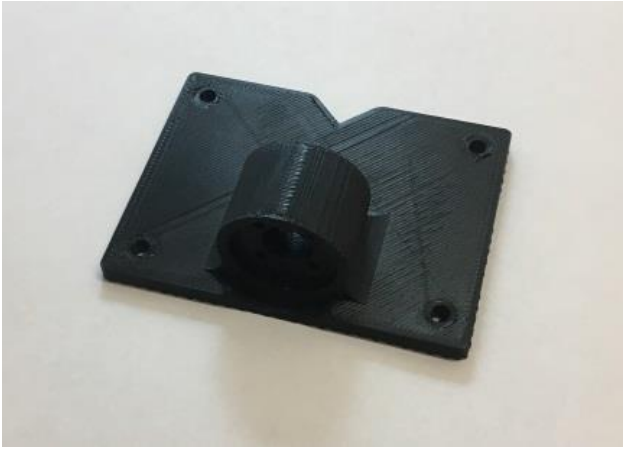

DRIVE MOUNT (x1)



BEARING SPACERS

You will need 2 spacers:

- (1) 13mm spacer
- (1) 15mm spacer

(They look identical except for the height)

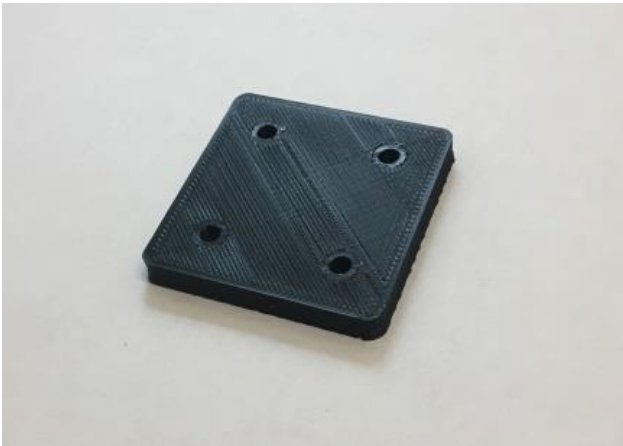

BLOCK SPACER (x4)

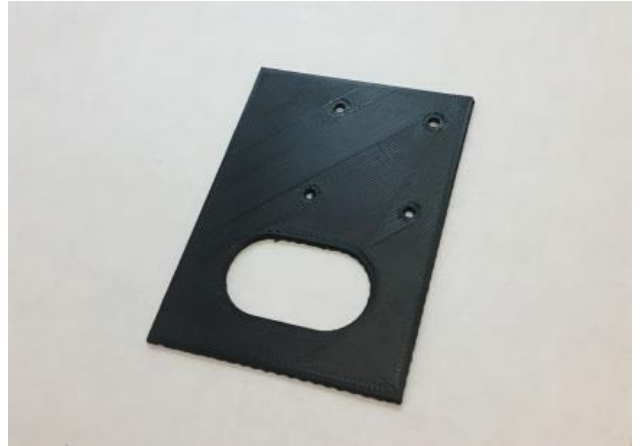

TEMPLATE (x1)





Nema 17 Bipolar 59Ncm (84oz.in) 2A 42x48mm 4 Wires w/ 1m Cable & Connector

★★★★★ 19 reviews | Write a review

SKU: 17HS19-2004S1

\$11.14 ~~\$14.71~~

Bulk quantity price break:

Qty	3	10	30	100
Price	\$10.70	\$9.81	\$9.36	\$8.47
Save	27%	33%	36%	42%

Availability: 8126

* Ship from

[China](#) [United States](#) [Germany](#) [United Kingdom](#) [Australia](#) [Russian Federation](#)

- 1 + [ADD TO CART](#) [♡](#)

[Report error](#) / [Notify inventory](#) / [Request bulk price](#)

NEMA 17 stepper motor

SKU: 17HS19-2004S1



Nema 17 Bracket for Stepper Motor and Geared Stepper Motor Alloy Steel Bracket

★★★★★ 8 reviews | Write a review

SKU: ST-M1

\$2.44

Bulk quantity price break:

Qty	3	10	30	100
Price	\$2.28	\$2.12	\$1.96	\$1.79
Save	6.67%	13.33%	20%	26.67%

Availability: 471

* Ship from

[China](#) [United States](#) [Germany](#) [United Kingdom](#) [Australia](#) [Russian Federation](#)

- 1 + [ADD TO CART](#) [♡](#)

[Report error](#) / [Notify inventory](#) / [Request bulk price](#)

[Like](#) [Twitter](#) [Pinterest](#) [Share](#)

NEMA 17 bracket

SKU: ST-M1



SFU1204 12mm 500mm End Machine Ball Screw Single Flange BallNut US Stock



Price: **\$22.80** & **FREE Shipping**

New (1) from **\$22.80** + FREE Shipping

Specifications for this item

Part Number	1SBA1733140VQ0G409
UPC	190459164566
Brand Name	CHUANGNENG

Qty.(1) SFU1204 Ball Screw. In this build we are using 500mm long screw and guides but you can use any length you like. This item is typically available from Amazon, AliExpress or other online bearing suppliers – There are a number of brands out there but any SFU1204 will work.

CNC Linear Guide Way Rail Kit Set --- 2pcs Fully Support SBR 12-500mm 12mm Ball Bearing Linear Slide Rail Shaft + 4pcs SBR12UU Blockbearing

[Be the first to review this item](#)

Price: **\$61.29** & **FREE Shipping**

Note: Not eligible for Amazon Prime.

In Stock.

Get it as soon as March 28 - April 18 when you choose **Standard Shipping** at checkout.

Ships from and sold by [nineone](#).

- Metal linear bearing rail and blocks with pre-drilled holes for ease of mounting
- Durable construction for long-lasting performance
- Can be used in automatic industry machines such as robot, calculator, automatic recorder, accurate printer, etc.
- This set included 2pcs SBR12-500mm Linear Bearing Rail and 4pcs SBR12UU Block Bearing.
- This linear bearing is durable and sturdy, which can prolong the transmission life span of your machines.



Qty.(1) SBR-12 12mm linear slide with bearings. In this build we are using 500mm long screw and guides but you can use any length you like. This item is typically available from Amazon, AliExpress or other online bearing suppliers.



PGN - KP08 Pillow Block Ball Bearing - 8mm Bore - P08 Base (2 Pack)



Price: \$6.45 ✓prime

New (1) from \$6.45 ✓prime FREE Shipping

Specifications for this item

Part Number	PB-KP08/2
UPC	760655001042
Measurement System	Metric
Specification Met	Iso 9001 , Aisi 52100
Bore Diameter	8.00 millimeters

Qty.(1) KP08 – 8mm bore pillow block bearing. These are typically sold in pairs of 2 so you will have 1 extra. This item is typically available from Amazon, AliExpress or other online bearing suppliers.

PGN - KP000 Pillow Block Ball Bearing - 10mm Bore - P000 Base (2 Pack)



★★★★★ 1 rating

Price: \$7.45 ✓prime

New (1) from \$7.45 ✓prime FREE Shipping

Specifications for this item

Part Number	PB-KP000/2
UPC	760655001028
Measurement System	Metric
Specification Met	Iso 9001 , Aisi 52100
Bore Diameter	10.00 millimeters

Qty.(1) KP000 – 10mm bore pillow block bearing. These are typically sold in pairs of 2 so you will have 1 extra. This item is typically available from Amazon, AliExpress or other online bearing suppliers.



4 Pin Metal Male Female Panel Connector 10 GX16-4 Silver Aviation Plug of 10 pcs

★★★★☆ 1 customer review

Note: This item is only available from third-party sellers (see all offers)

Available from these sellers.

- Product Name : Aviation Connector Plug;Model : 16-4;Type : Male Female
 - Contacts Pin Number : 4
 - Rated : 125V/5A;WorkingVoltage : AC 200V;Withstand Voltage : AC
 - Total Size : 4.7 x 1.9cm/ 1.8" x 0.7" (Lx Max.W);
 - Material&Package: Metal;10 Pairs Aviation Connector Plug
- › See more product details

Compare with similar items

New (1) from \$12.99 + \$5.27 shipping

GX-16 aviation plug (x2)

6061 Aluminum Sheets, Bars, and Cubes



Bars

Wd.	Temperature Range, °F		1 ft. Lg.
1/4" Thick. (-0.012" to 0.012" Tolerance)			
6"	-320° to 300°	8975K437	\$13.37

6061 Aluminum, 1/4" Thick x 6" Wide, 1 Foot Long

Each

ADD TO ORDER

In stock

12" x 6" x 1/4" aluminum plate (x1)- McMaster Carr

Additional Axis Assembly

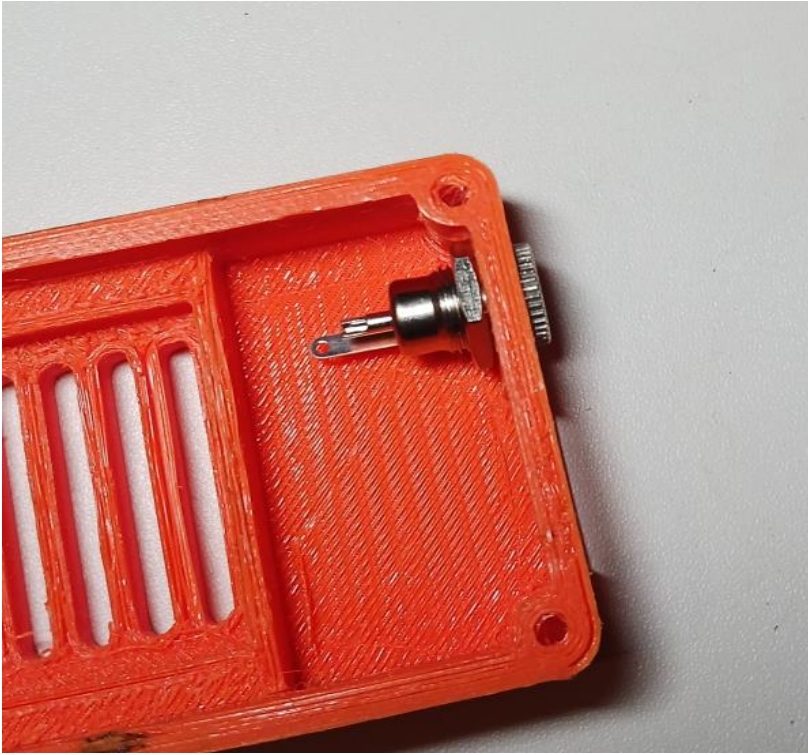

Remove all build structure from 3D printed Base Enclosure Fan Cover then install the 5.5mm power jack as shown.

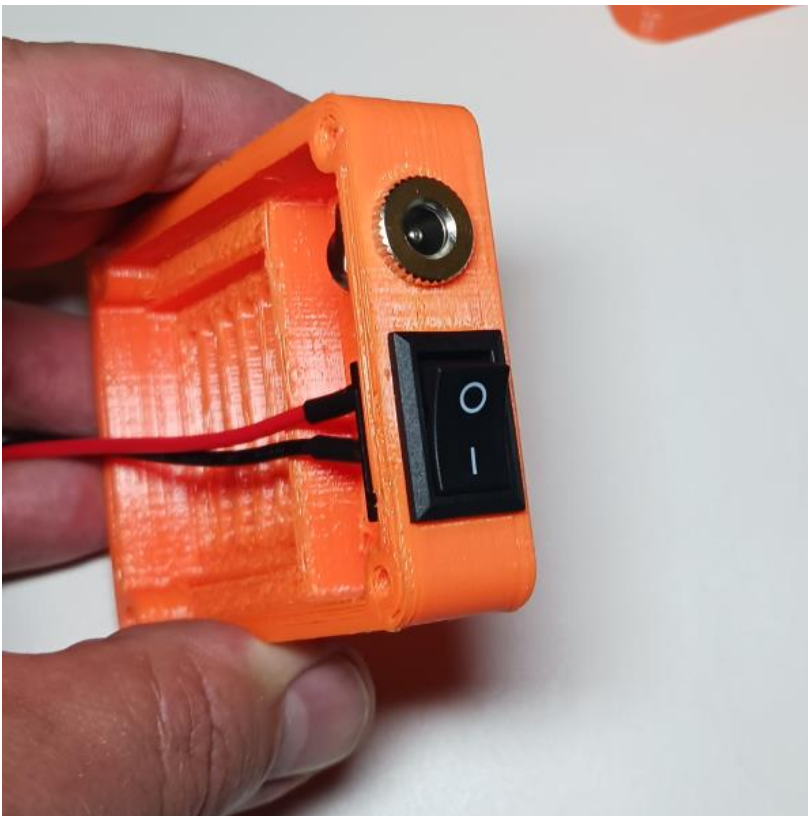

Install rocker switch as shown. Rocker switch will snap into position.

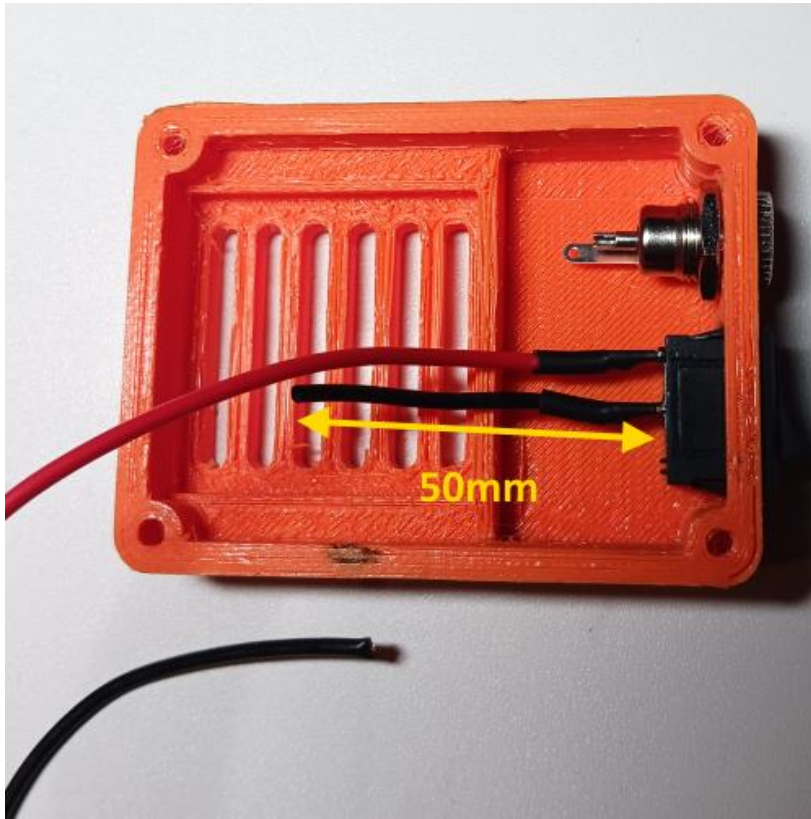

Cut the rocker switch black wire as shown leaving 50mm of wire extended from the rocker switch.

Save the remainder black wire for the next step.

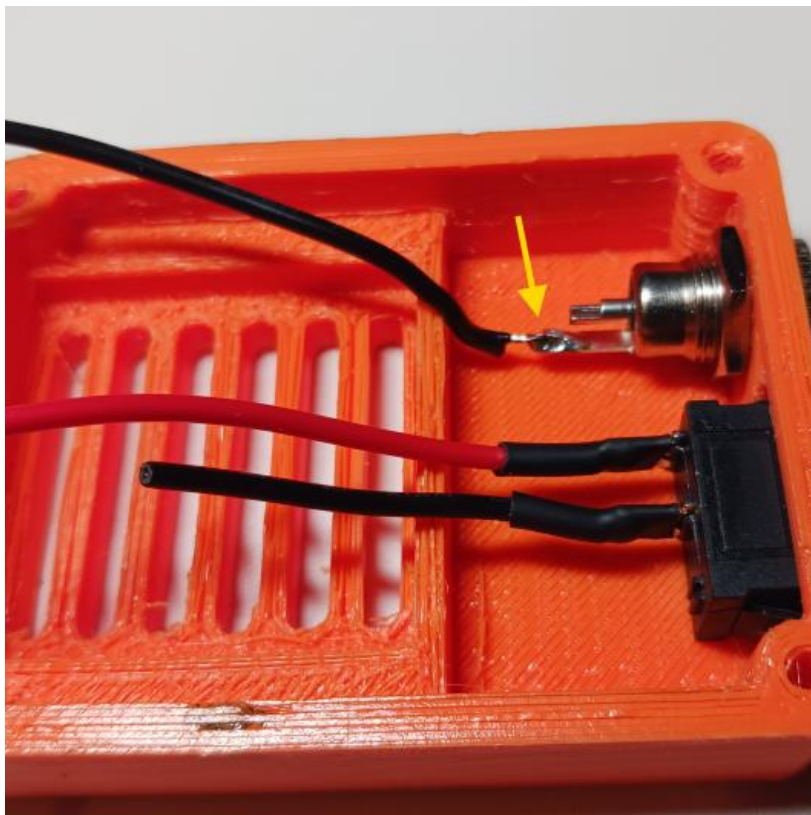

Strip 3mm of sheathing from the end of the black remainder wire and then solder the wire to the 5.5mm power sockets ground connection tab as shown.

NOTE: The ground connection tab is the longer tab coming from the socket outer housing as shown.

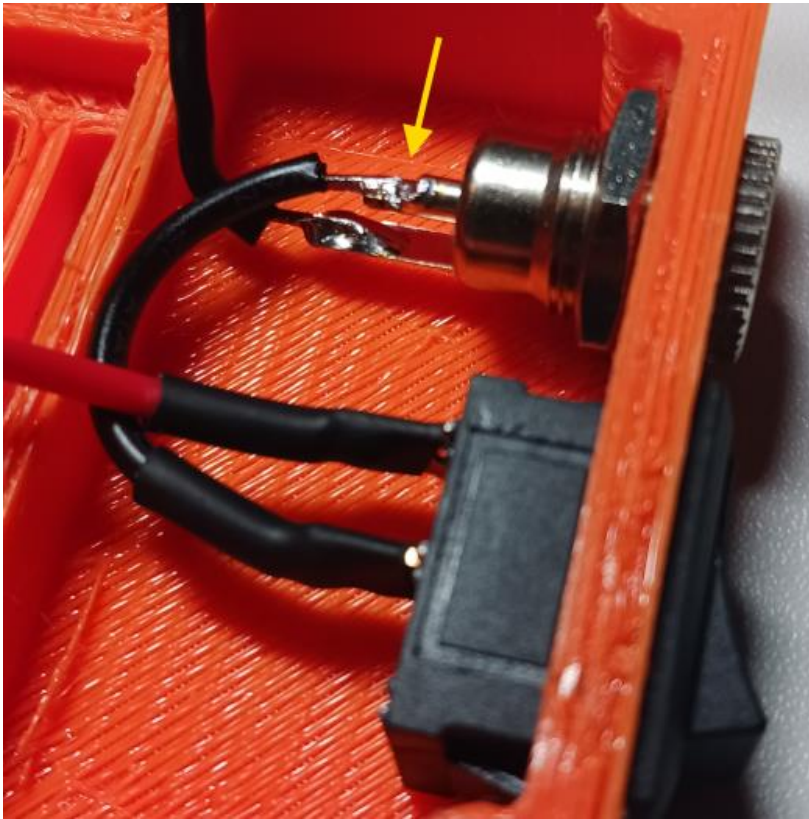

Remove 3mm of sheathing from the rocker switch black wire and then solder the rocker switch black wire to the positive center terminal on the 5.5mm power jack as shown.

NOTE: the positive terminal is the one in the center of the power jack. Make sure solder connections to each of the power jack terminals are solid and that there are no stray strands of wire and that there are no possibilities of a short between the power jack terminals.

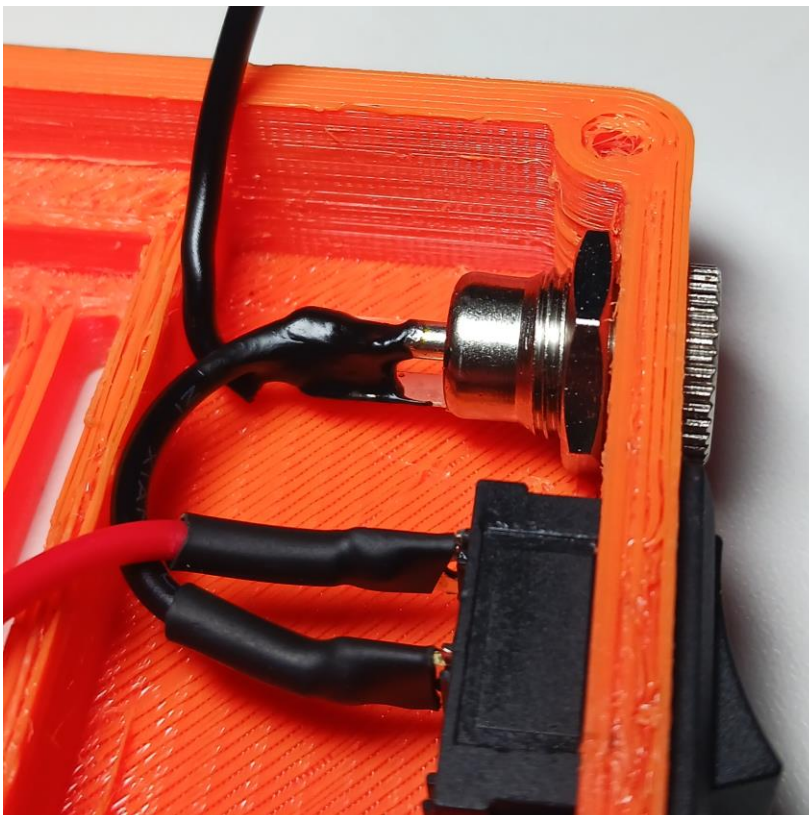

Apply liquid electrical tape to the power jack terminals ensuring there is possibility of a short between the power jack terminals.

NOTE: allow liquid electrical tape to dry and harden completely before moving to the next step.



Insert 40mm cooling fan into housing as shown. The fan label should be facing out.

NOTE: The fan is a snug slip fit into housing and is not secured with any fasteners.



Feed the red and black power wires as well as the cooling fan wires through the auxiliary enclosure access hole as shown.



Secure fan switch cover to the auxiliary enclosure using (4) #6 thread form screws.

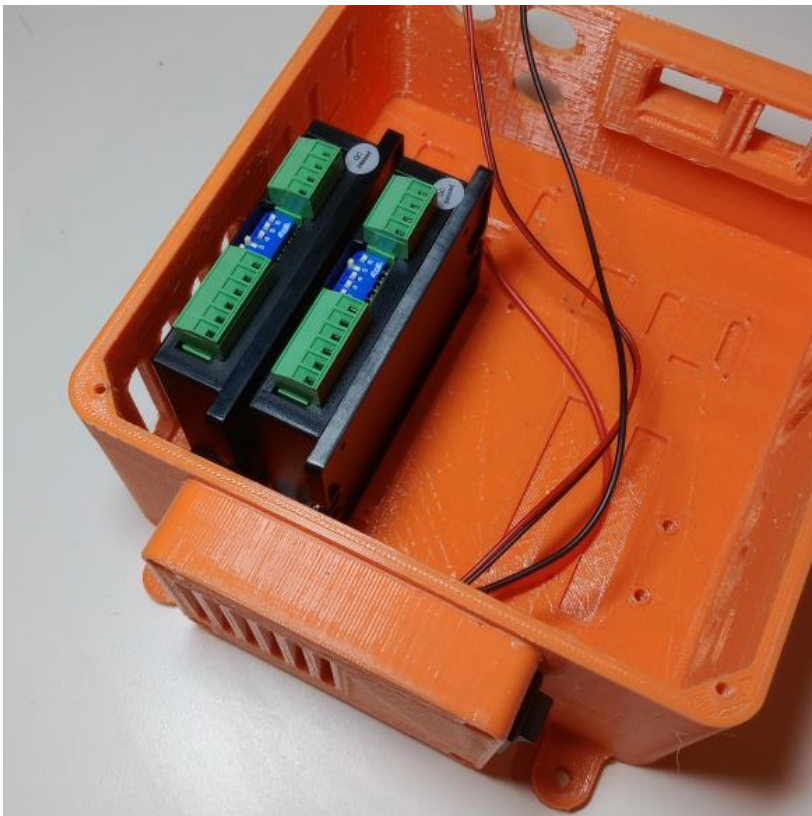

Install the 7th axis and 8th axis drive as shown and secure with #6 thread form screws.

If a 9th axis is desired you can install the next drive just to the right of the 8th axis drive shown.

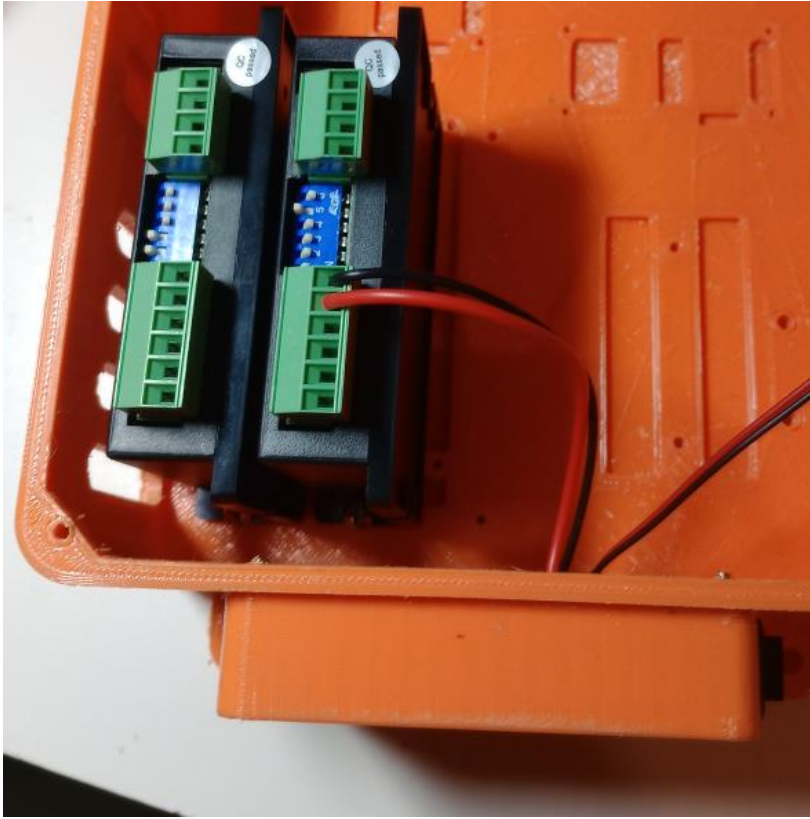

Trim red and black power wires to length shown and then connect the red wire to the +Vdc input, connect the black wire to the GND input on the driver shown.

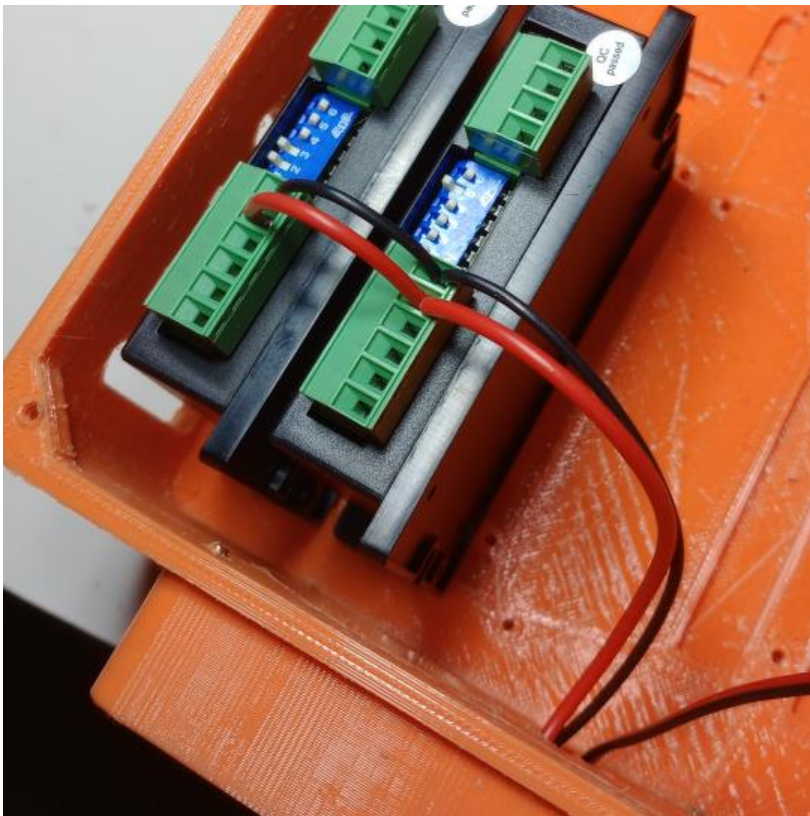

Use the remainder red and black wires to jumper power from the first driver across to the other driver.

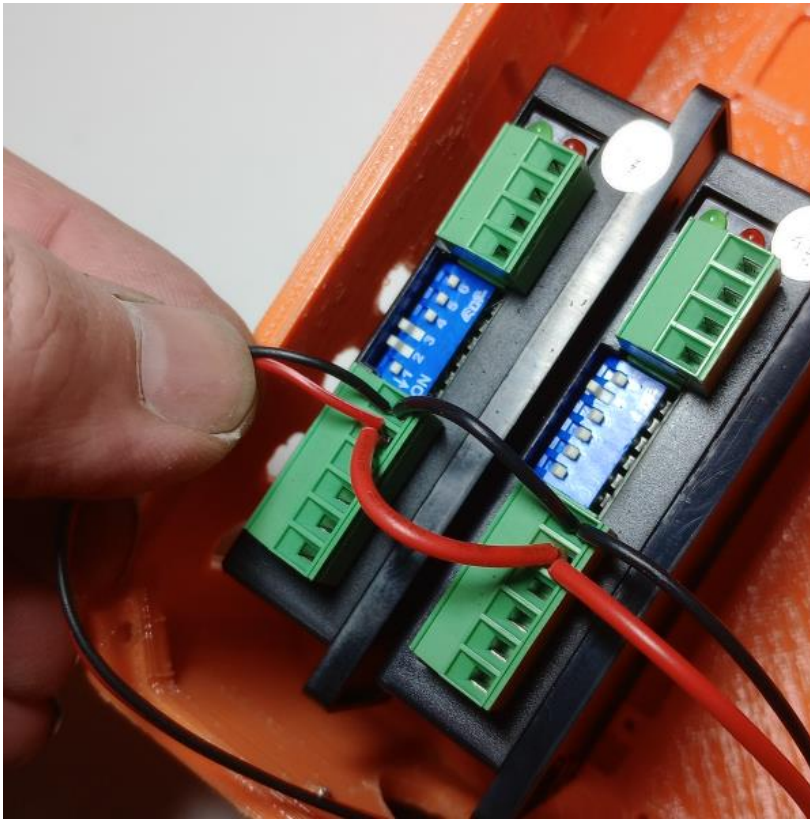

Trim the fan wires to the length shown and then connect the red wire to the +Vdc input and the black wire to the GND input on the last drive as shown.



Cut length of 18awg 4 conductor cable to a length of 20cm long.

You will need one length of cable for each driver.



Remove 3cm of cable jacket on one end and 6cm of jacket from the other end.

Strip all wire ends.

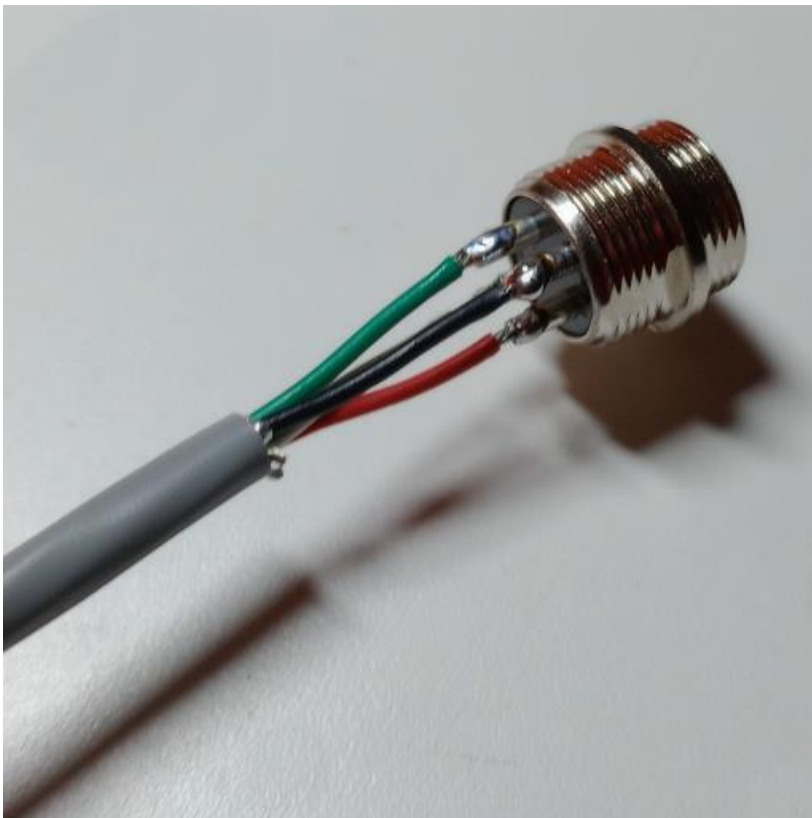

Solder the short end wires to the GX16 terminals as follows:

- #1 – BLACK
- #2 – RED
- #3 – WHITE
- #4 – GREEN

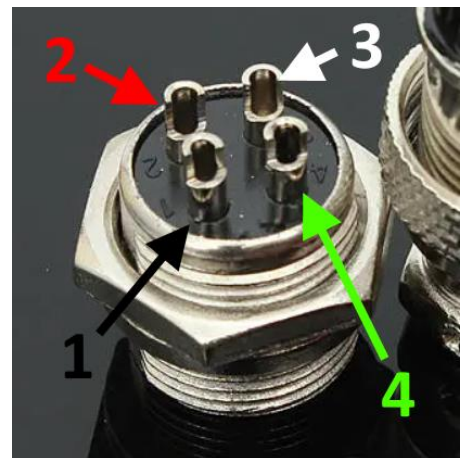

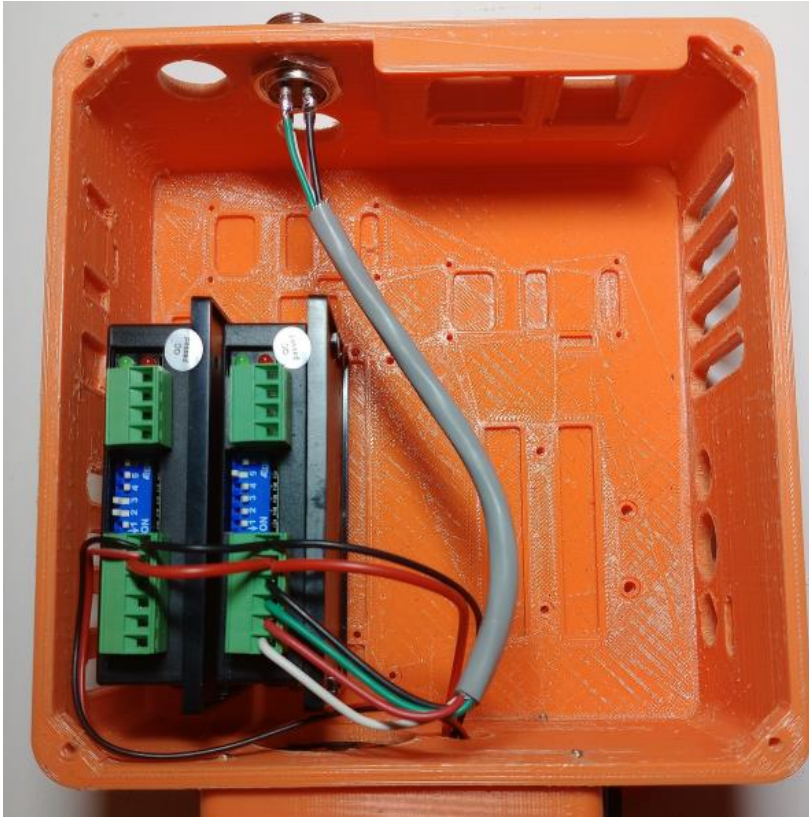

Install the GX16-4 plug into the enclosure as shown.

Connect the (4) J2 motor wires to the first driver terminals as follows:

A+ BLACK

A- GREEN

B+ RED

B- WHITE

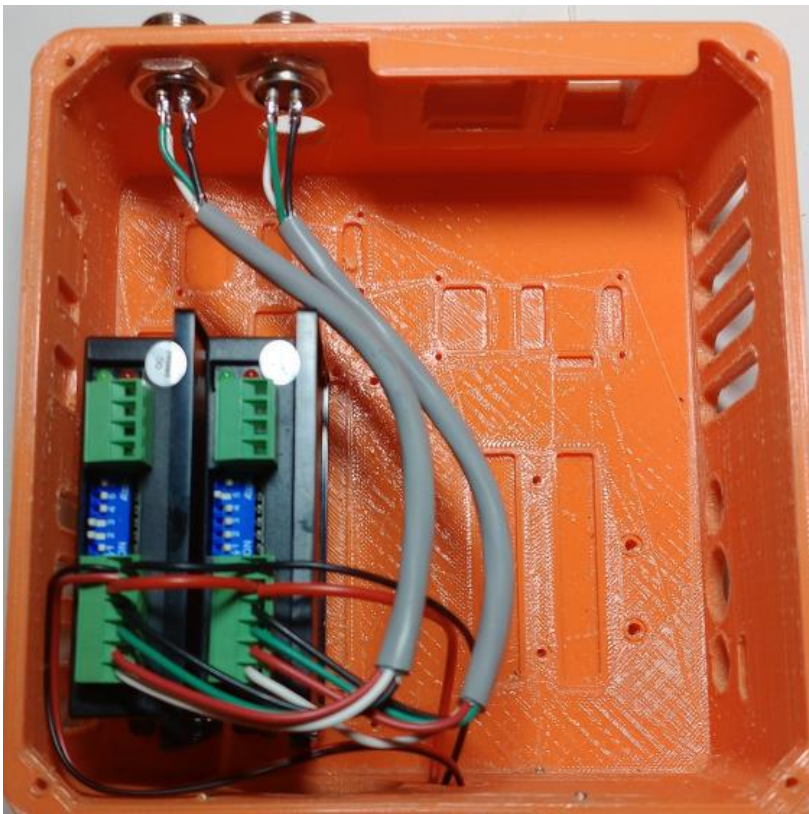

Repeat the last 3 steps and install GX16-4 plug for the 2nd drive.

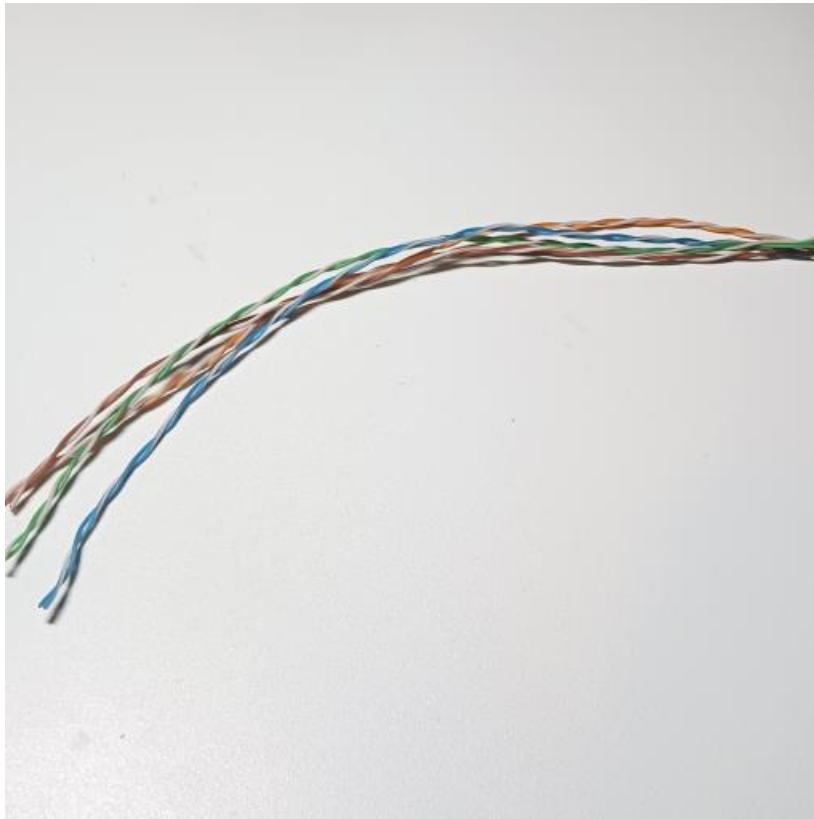

Cut Cat5 cable to length of 15cm and remove outer sheathing from cable.

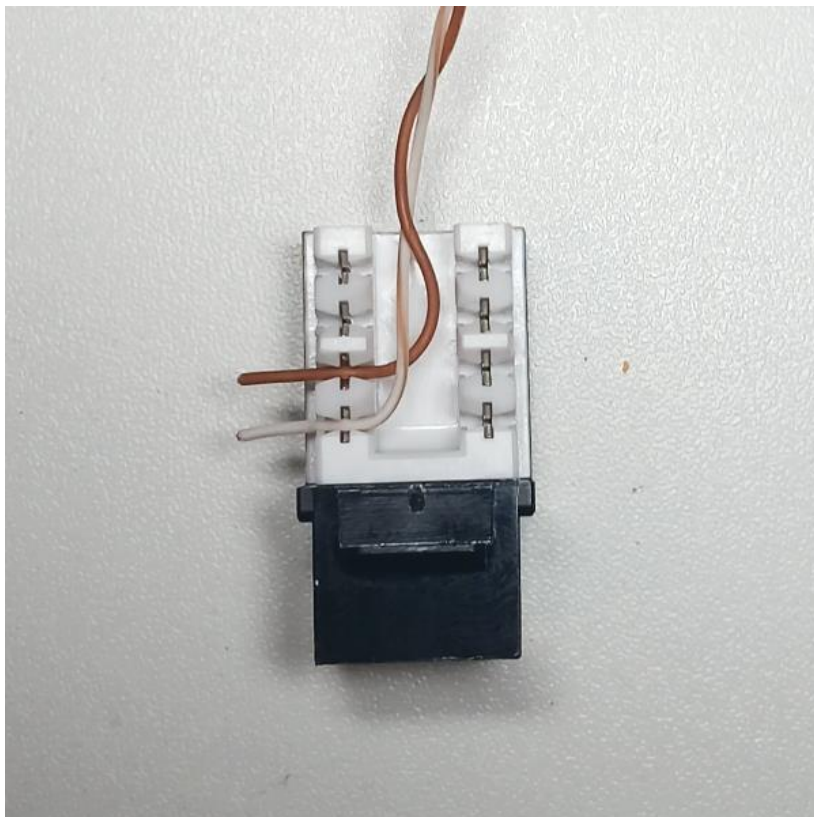

Insert the brown stripe wire into terminal #7 of the CAT6 Keystone Jack.

Insert the solid brown wire into terminal #8 of the CAT6 Keystone Jack.

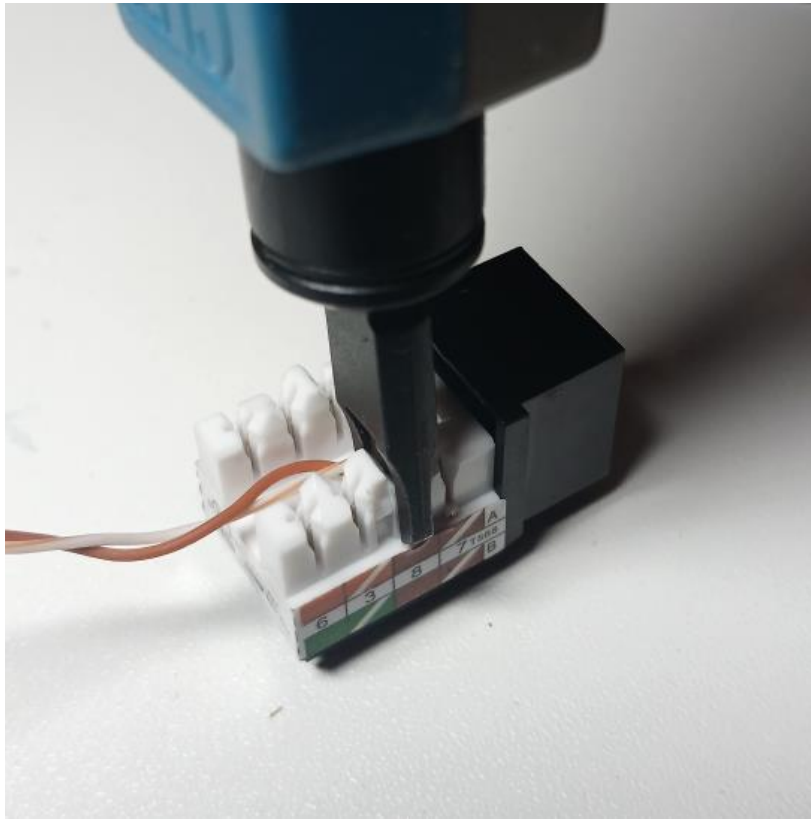

Use a keystone punch down tool to seat and trim both wires into the CAT6 Keystone Jack.

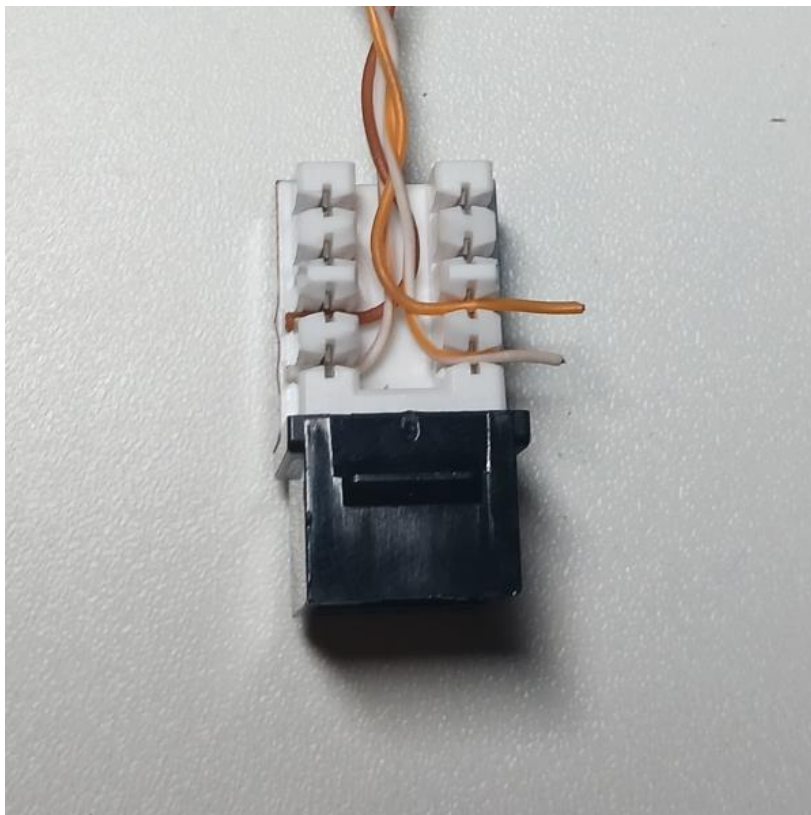

Insert the orange stripe wire into terminal #1 of the CAT6 Keystone Jack.

Insert the solid orange wire into terminal #2 of the CAT6 Keystone Jack.

Then use a keystone punch down tool to seat and trim both wires into the CAT6 Keystone Jack.

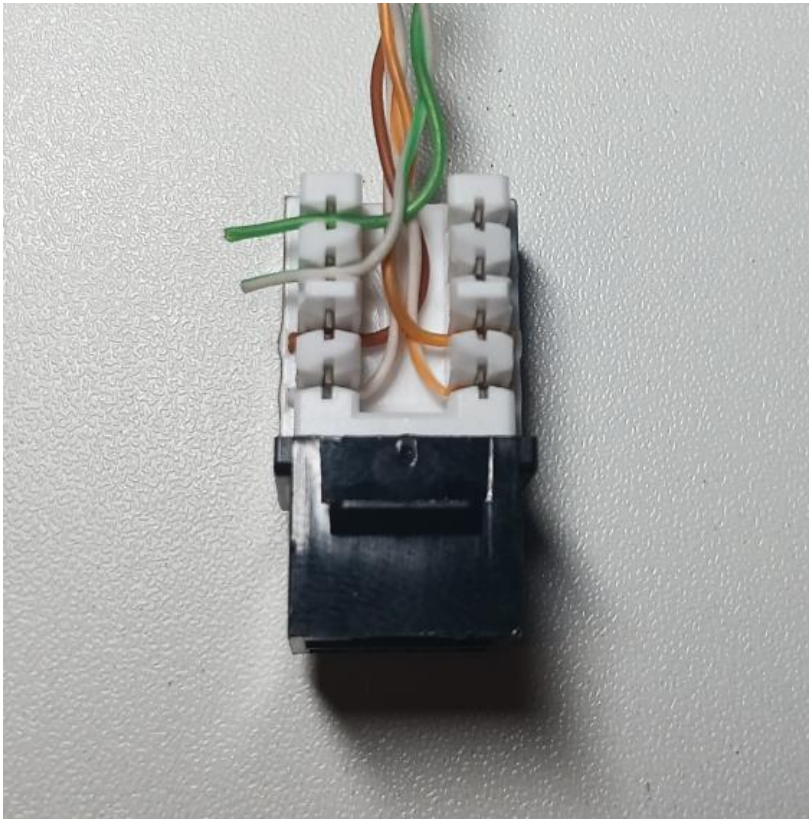

Insert the green stripe wire into terminal #3 of the CAT6 Keystone Jack.

Insert the solid green wire into terminal #6 of the CAT6 Keystone Jack.

Then use a keystone punch down tool to seat and trim both wires into the CAT6 Keystone Jack.

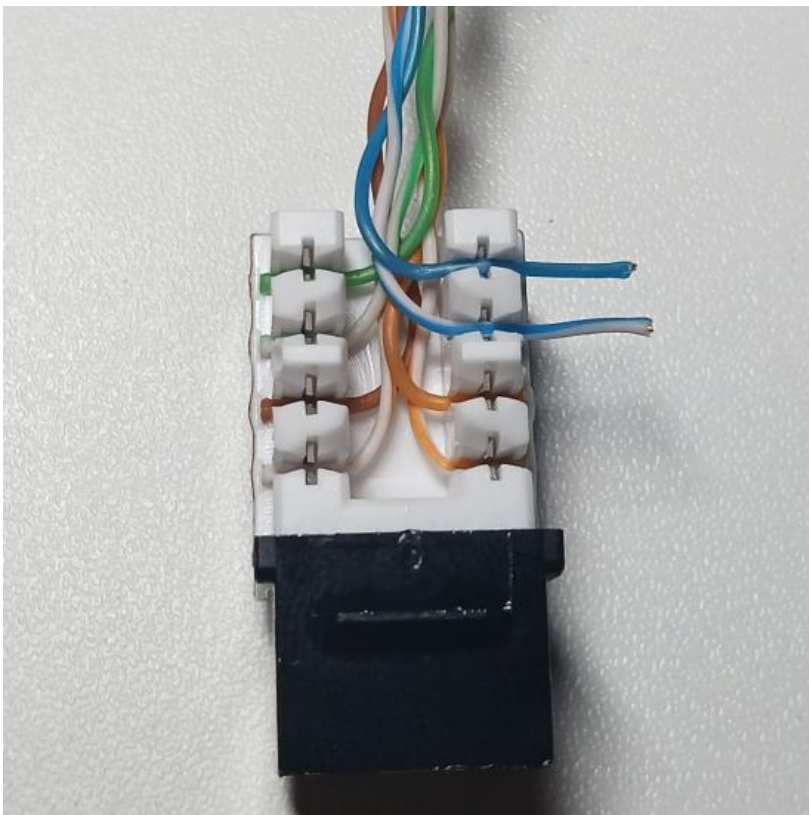

Insert the blue stripe wire into terminal #5 of the CAT6 Keystone Jack.

Insert the solid blue wire into terminal #4 of the CAT6 Keystone Jack.

Then use a keystone punch down tool to seat and trim both wires into the CAT6 Keystone Jack.



Install keystone jack into left socket in enclosure as shown.

Connect the green wire to the OPTO input on the J7 driver, then jumper a green wire from the J7 driver to the J8 driver.

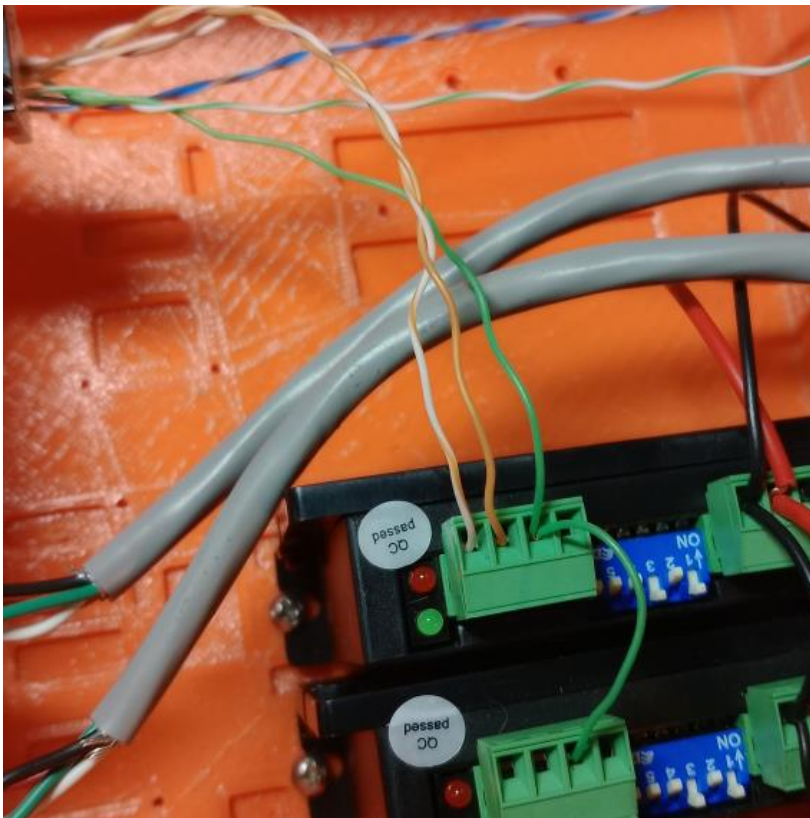

Connect the solid orange wire to the DIR input on the J7 driver.

Connect the orange stripe wire to the PUL input on the J7 driver.

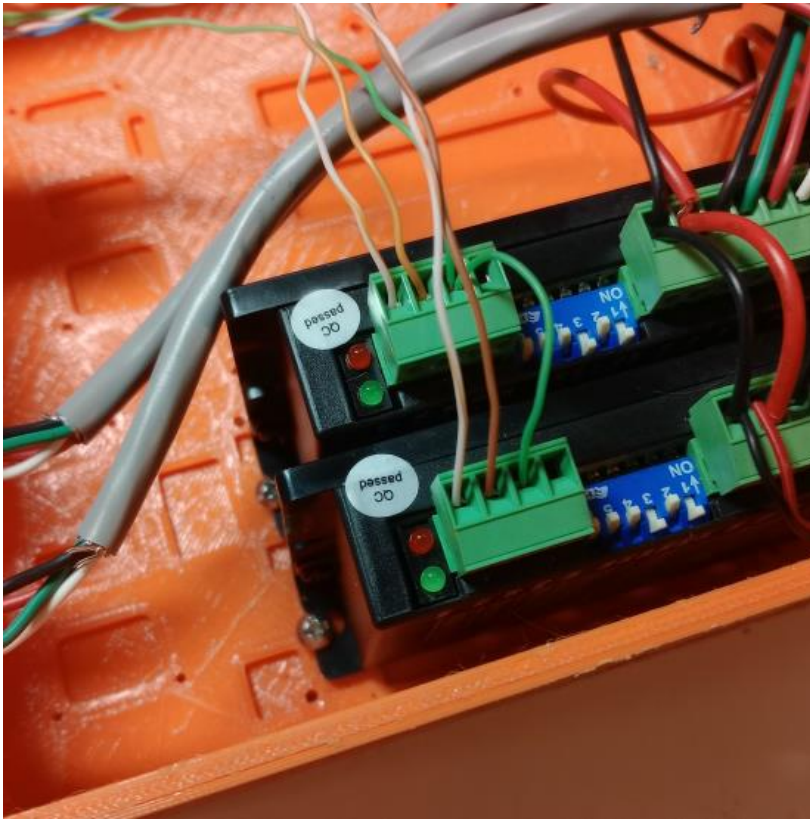

Connect the solid brown wire to the DIR input on the J8 driver.

Connect the orange stripe wire to the PUL input on the J8 driver.

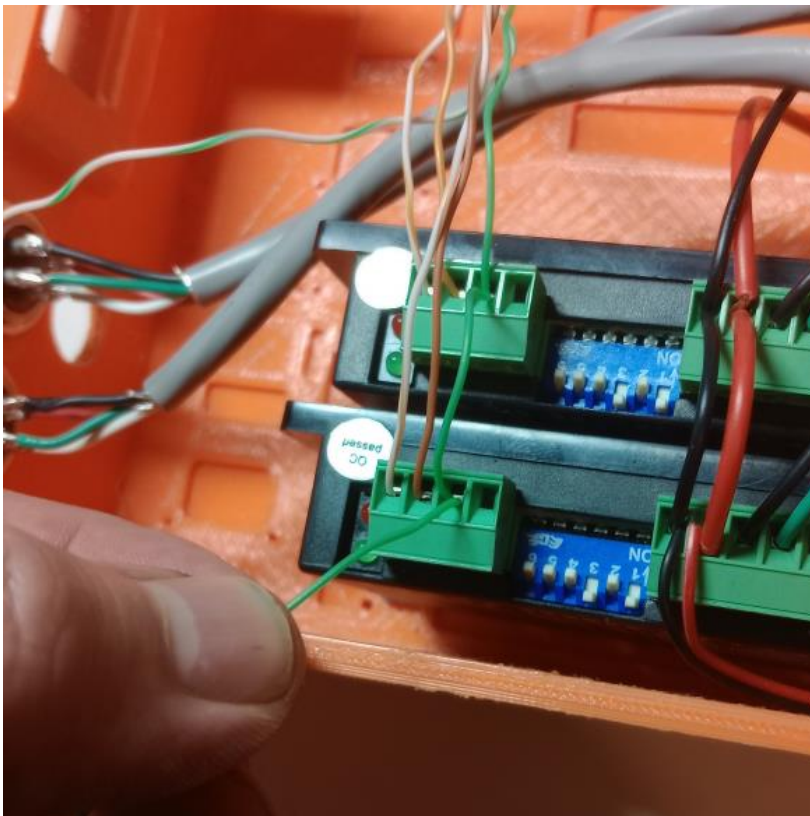

Connect 15cm long green jumper wire to the J

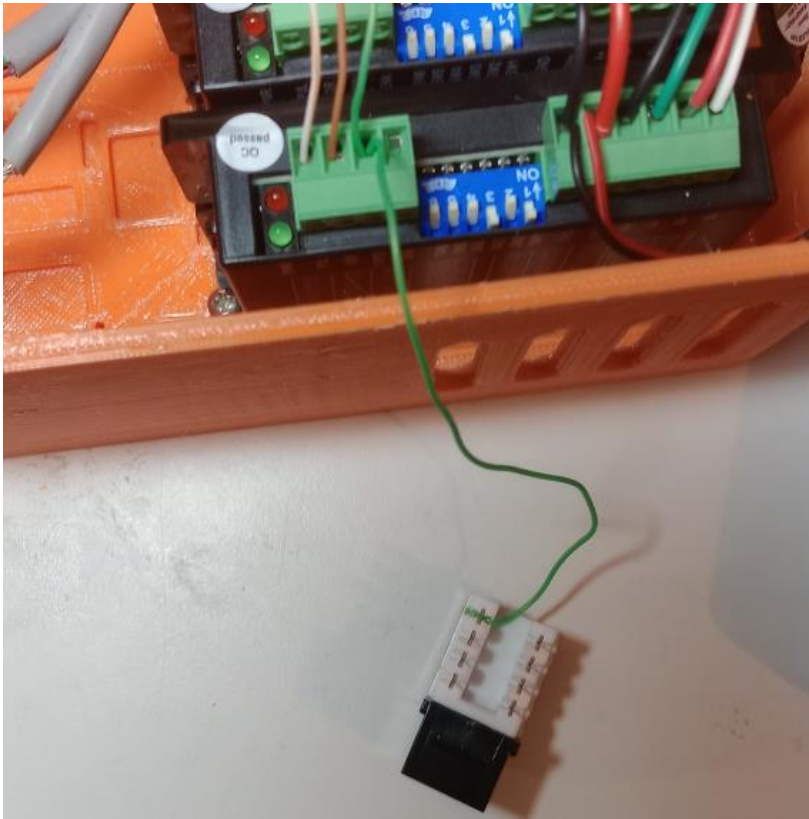

Use keystone punch down tool to secure the solid green jumper wire to terminal #6 on keystone jack.

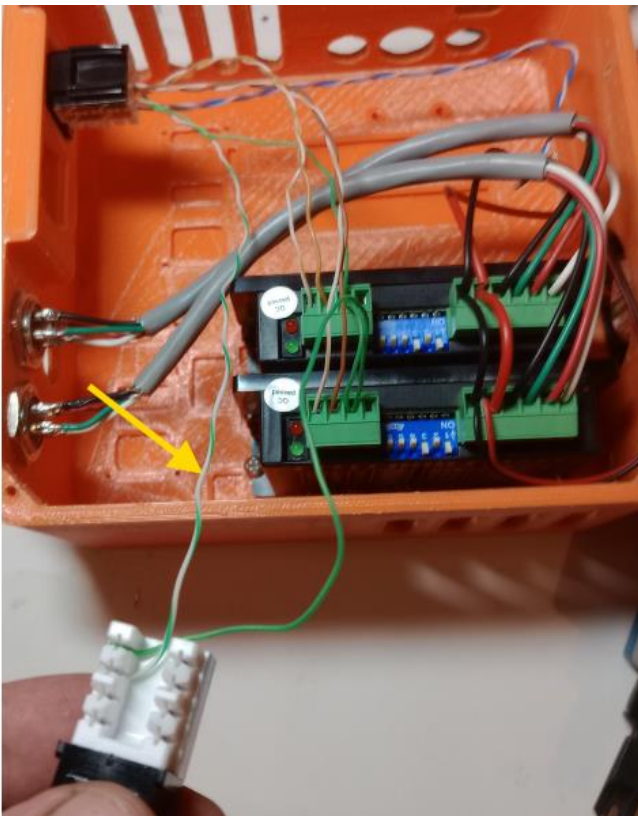

Use keystone punch down tool to secure the green stripe wire from the first keystone jack to terminal #3 on the second keystone jack.

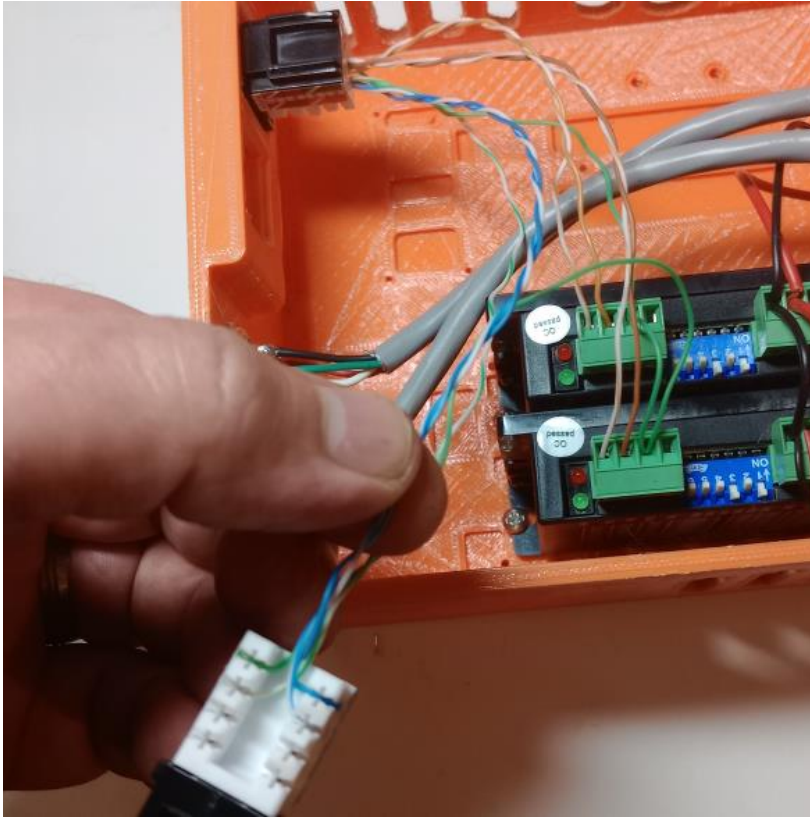

Use keystone punch down tool to secure the solid blue wire from the first keystone jack to terminal #4 on the second keystone jack.

Secure the blue stripe wire from the first keystone jack to terminal #5 on the second keystone jack.

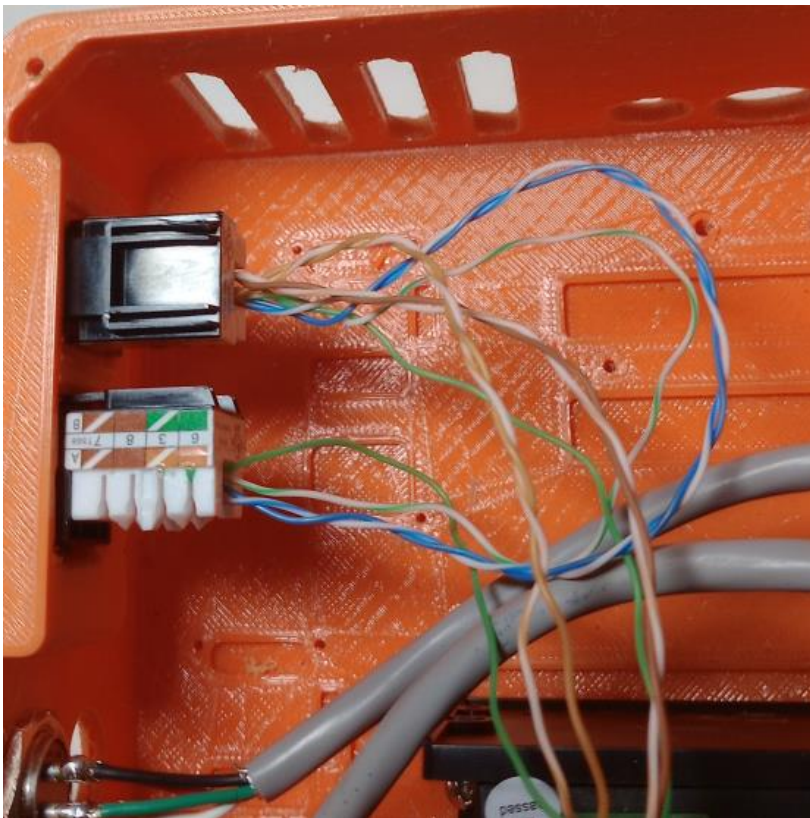

Install second keystone jack in enclosure as shown.

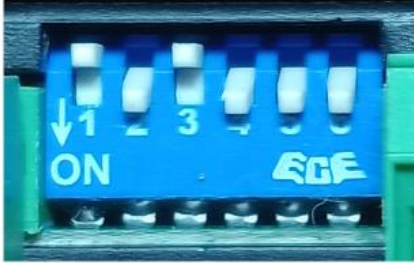

NEMA 17 SETTING FOR DM332T

You will need to set the drives dip switch settings. If your 7th or 8th axis is a nema 17 motor as shown in this chapter then use the same driver settings as the robot uses for joint 1 or joint 3. If you have selected a different motor for your additional axis you will need to consult the motors manual to determine the correct settings.



Install enclosure lid and secure with (4) #6 thread form screws.



Place template on corner of aluminum plate as shown and then use spring loaded center punch to mark the 4 holes. Rotate and flip template to each corner and repeat until all 16 holes are marked.



Drill all 16 holes to clearance 5mm screw.



Countersink all 16 holes.



Draw centerline on aluminum plate as shown.





Place drive mount on plate aligned on centerline. Use spring loaded center punch to mark (x4) holes.



Drill and tap (x4) M4 holes as shown.



Center J1 base enclosure as shown and mark (x4) mounting holes.

(note this is an older picture from the AR2 base)

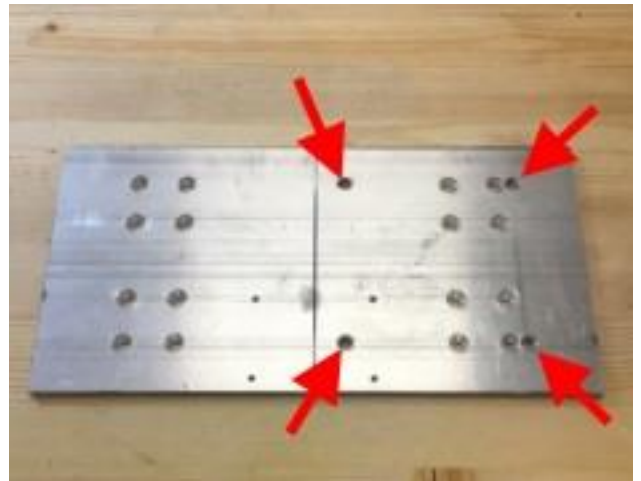

Drill and tap (x4) M8 holes as shown.



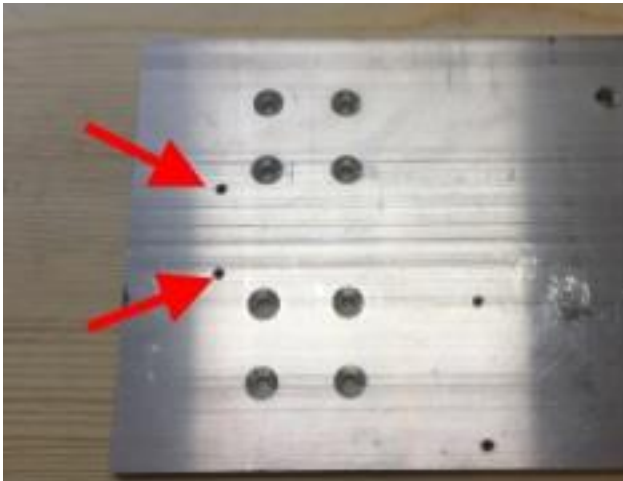

Drill and tap (x2) M4 holes centered 30mm apart and 30mm from edge as shown.

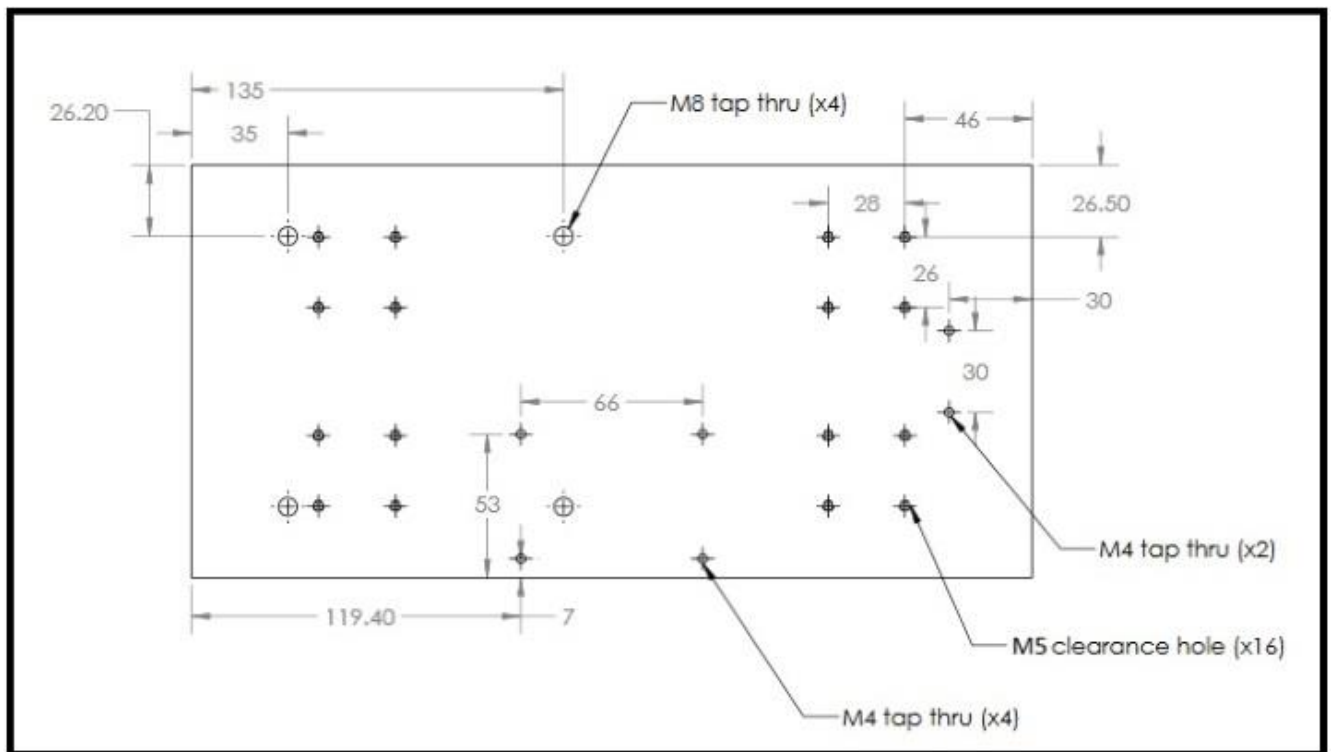

When complete aluminum plate should be drilled as shown in this drawing.





Install (x4) linear bearings with block spacers between aluminum plate and bearing as shown. Secure with (x16) M5x20 flat head screws. (do not fully tighten M5 screws yet)



Secure drive mount assembly to aluminum plate as shown using (x4) M4x20 socket head cap screws.

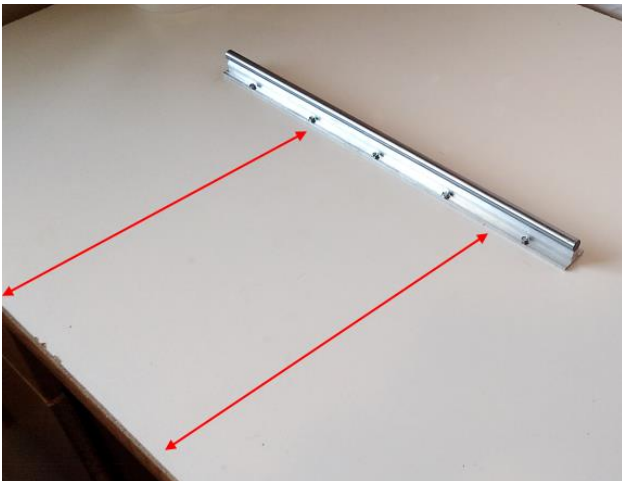

Mount the first rail to your table or workspace. Make sure rail is parallel to table (red arrows) and positioned where you want it. Secure rail with screws in each mounting hole using wood screws or cap screws depending on the surface you are mounting to.



Slide 2nd rail into rear pair of linear bearings as shown.



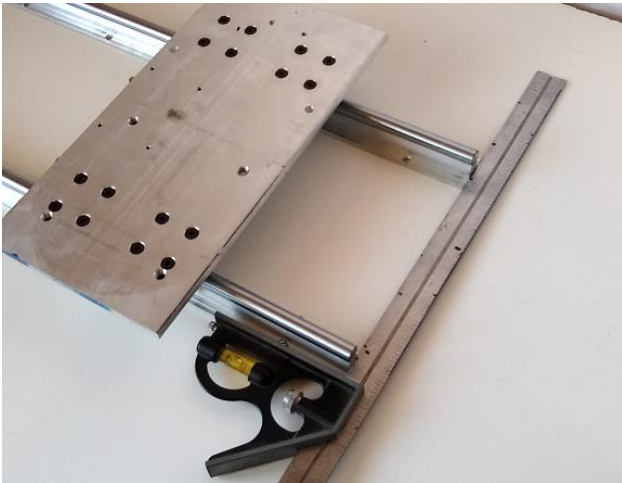

Slide aluminum plate & front pair of linear bearing onto the front rail which is secured to table. The rear rail is still free – use square to make sure rear rail is aligned with front rail.

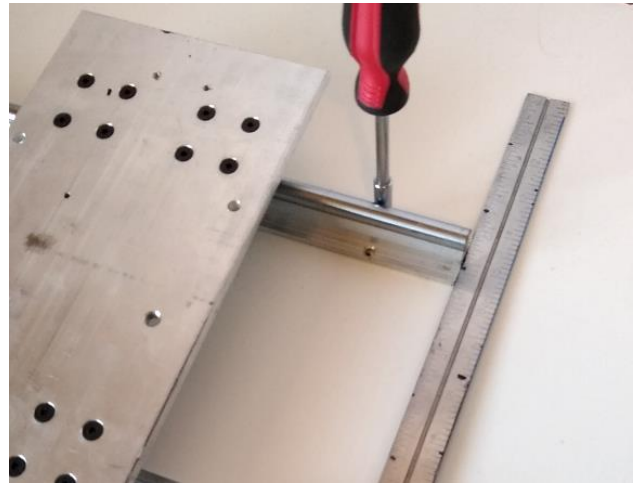

Secure rear rail with screws in each mounting hole using wood screws or cap screws depending on the surface you are mounting to.



Install T8 screw, bearing and motor coupler as shown.





With platform at maximum travel to the left side secure lead screw bearing and bearing spacer to work table as shown.

Tighten bearing and coupler set screws.



Turn screw manually and drive platform to far end. Secure opposite lead screw bearing and bearing spacer as shown at very end of screw.

Tighten bearing set screws.



Note that the drive mount should bottom out against the bearing and not allow the platform to go off the end of the rails.

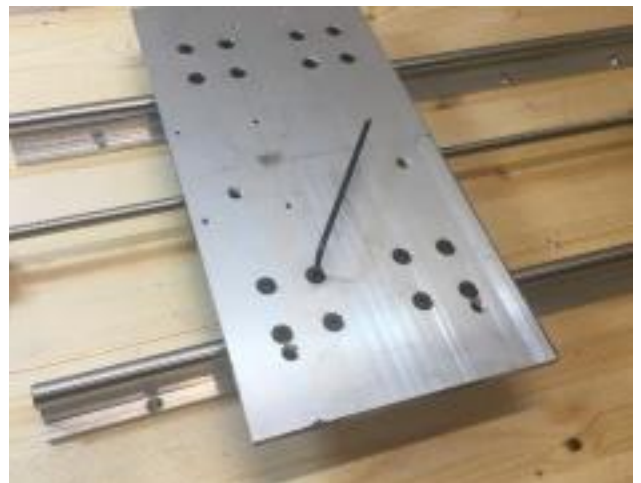

Make sure platform moves smoothly and easily down rails and then tighten the (x16) M5 screws securing platform to rail bearings.





Temporarily install motor and bracket and use pencil to mark motor mount location.



Remove motor and secure motor mount to work table as shown.



Reinstall motor using (x4) M3x10 socket head cap screws.

Tighten shaft coupler set screws.

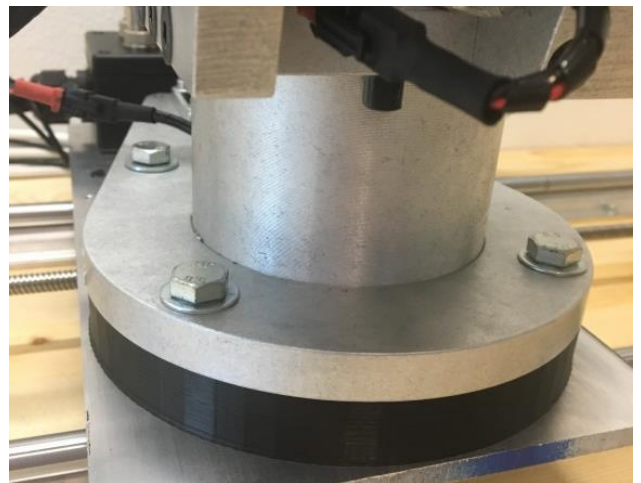

Secure robot to platform using (x4) M8x35 metric bolts.



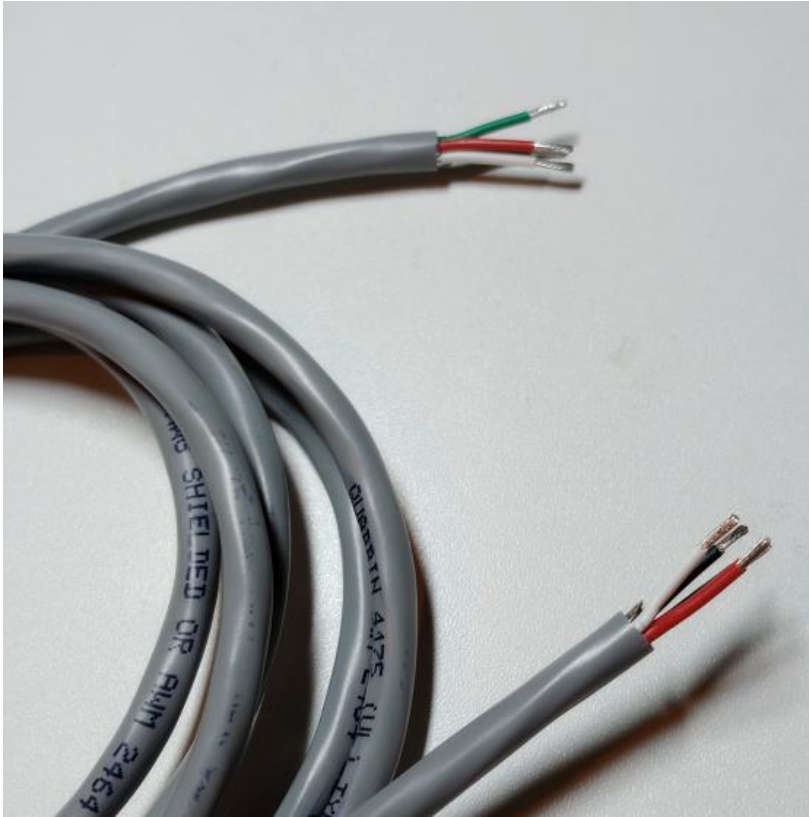

Remove 1.5cm of the jacket from each end of the remaining 175cm long 4 conductor cable.

Next strip the end of each individual wire as shown.

Remove the screw and cover from (1) female GX16-4 connectors.

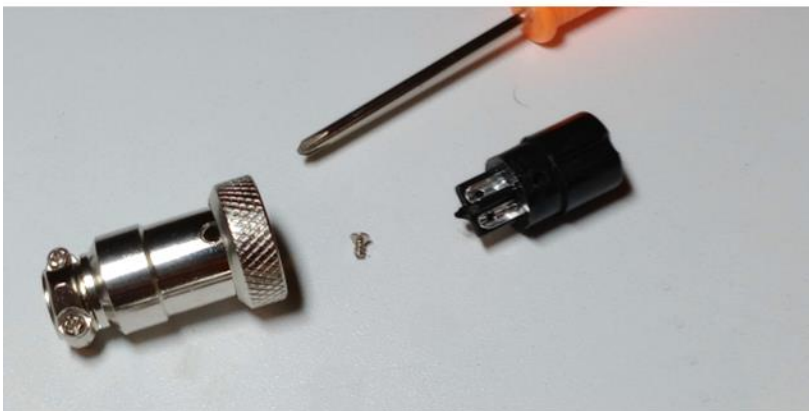

Slide GX16 connector cover over the end of the cable as shown.

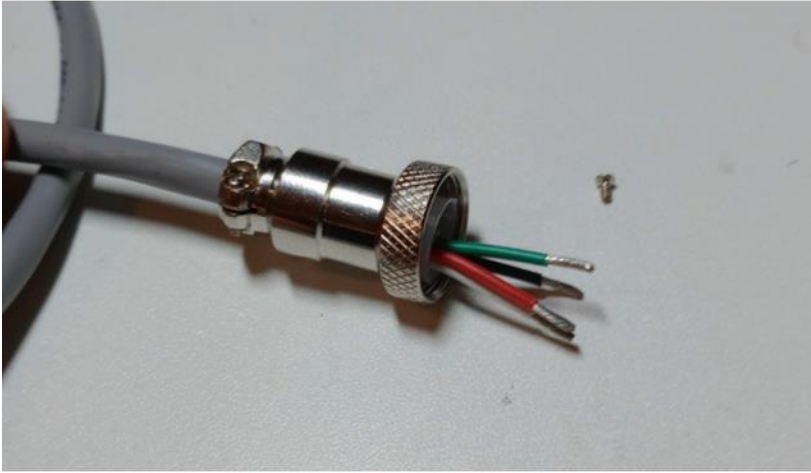

Solder the cable wire to the GX16 terminals as follows:

- #1 – BLACK
- #2 – RED
- #3 – WHITE
- #4 – GREEN

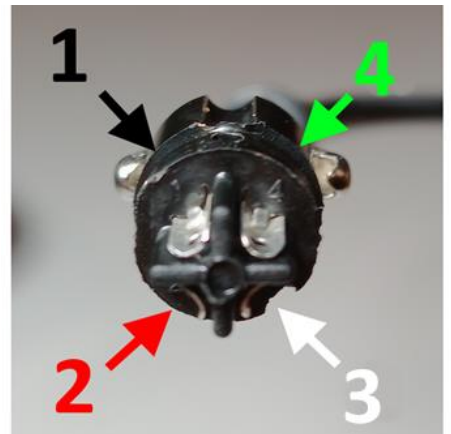



Reinstall connector cover, install retaining screw and tighten the cable clamp.



Slide a 6 to 8cm long piece of 6mm heat shrink tubing over the other end of the cable.

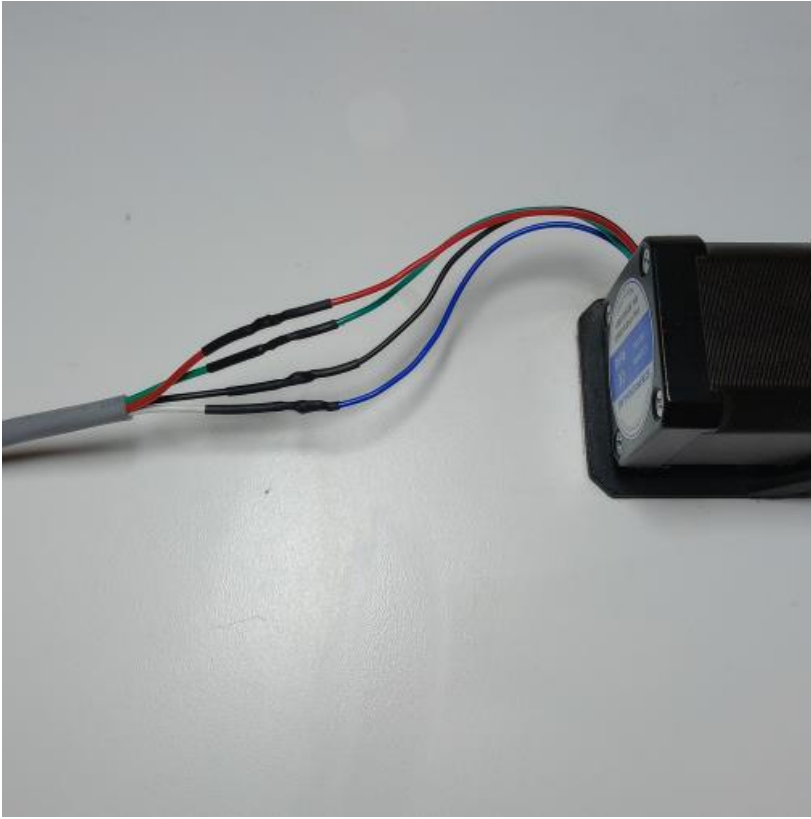

Solder and heat shrink the cable wires to the motor wires as follows:

- **Motor Red to cable Red**
- **Motor Green to cable Green**
- **Motor Black to cable Black**
- **Motor Blue to cable White.**



Slide larger 6mm heat shrink tube over the individual connections and apply heat to shrink tubing.

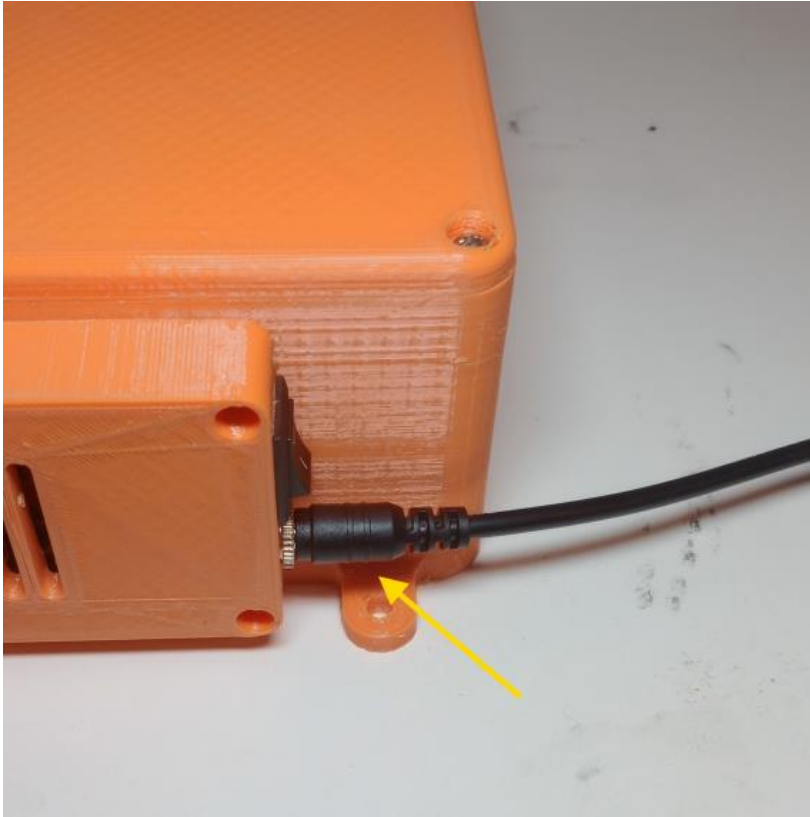

Connect 24vdc power supply to auxiliary enclosure.



Connect Ethernet cable from left jack to the robot.

With the robot powered on and the auxiliary enclosure powered on you should now be able to jo

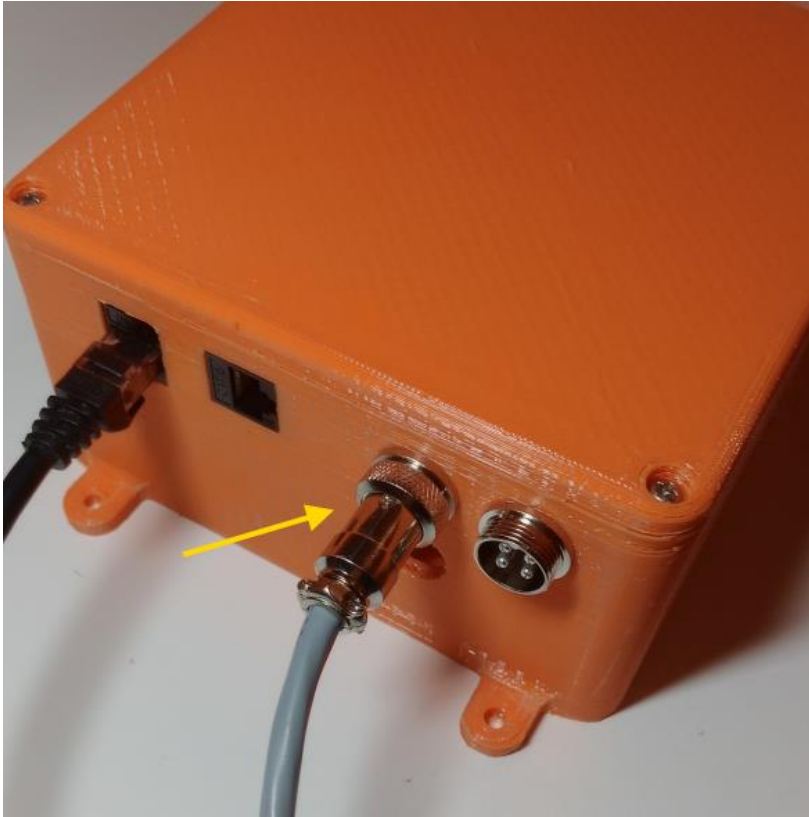

Connect motor cable to auxiliary enclosure GX14 socket for axis 7.

With the robot and auxiliary enclosure both powered on you should now be able to jog the 7th or 8th axis from the robot control software.

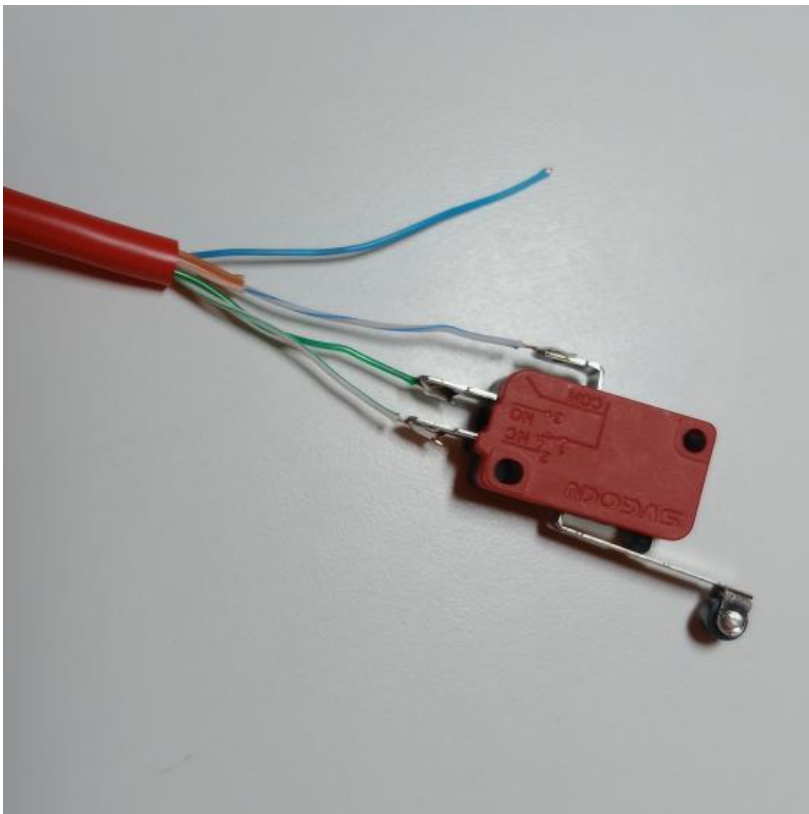

If you would like to add a homing switch or calibration switch to your auxiliary axis you will need to either fabricate an ethernet cable or just cut the end off of an inexpensive cable then solder connections as follows:

- Green stripe wire to NC terminal
- Solid green wire to NO terminal
- Blue stripe wire to COM terminal

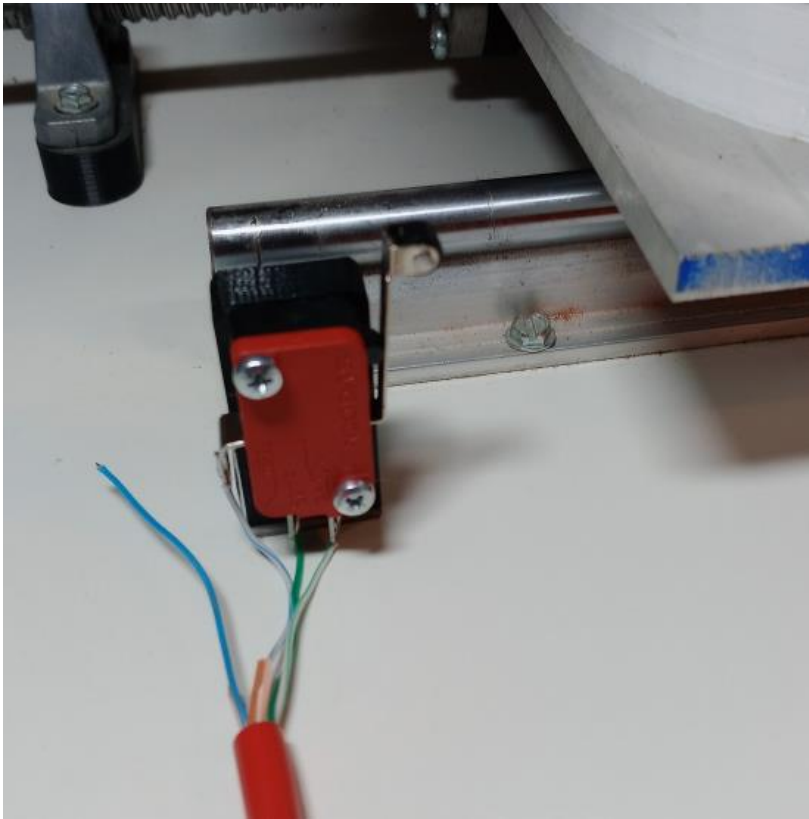

Mount the limit switch in whatever position you need for your additional axis.

Note the blue wire is for a limit switch for axis 8. You will need to jumper or extend the solid and stripe green wires to any additional limit switches.

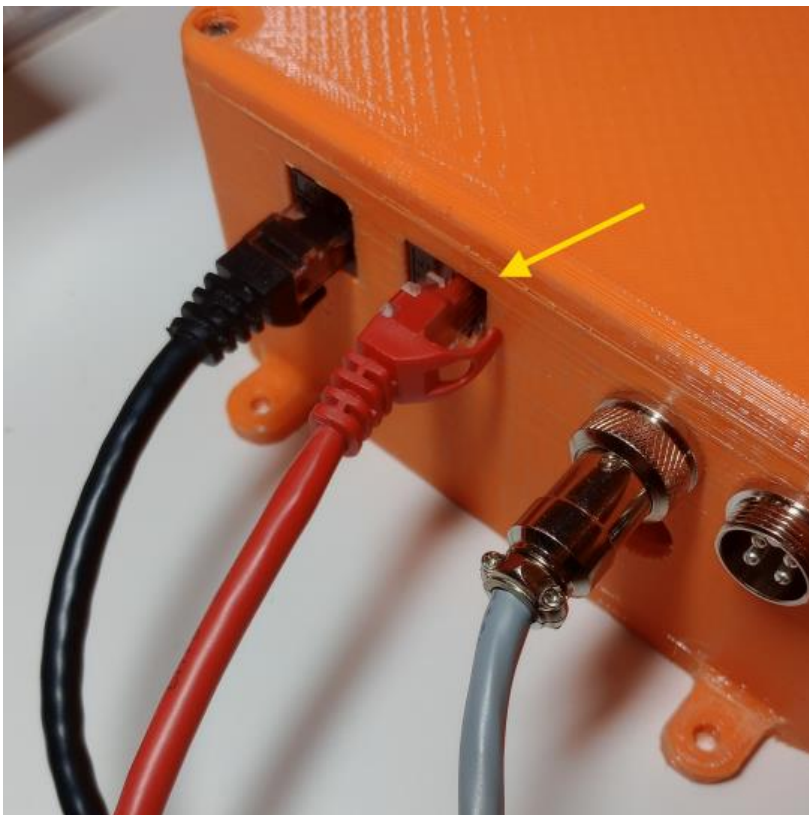

Plug the limit switch ethernet cable into the second jack in the auxiliary enclosure.

You should now be able to home or calibrate your additional axis.

Note: If you need a 9th axis you will need to run separate wires for the step and direction signals as the left keystone jack only has capacity for the 7th and 8th axis.

CHAPTER 7

ROBOT SPECIFICATIONS & DIAGRAMS



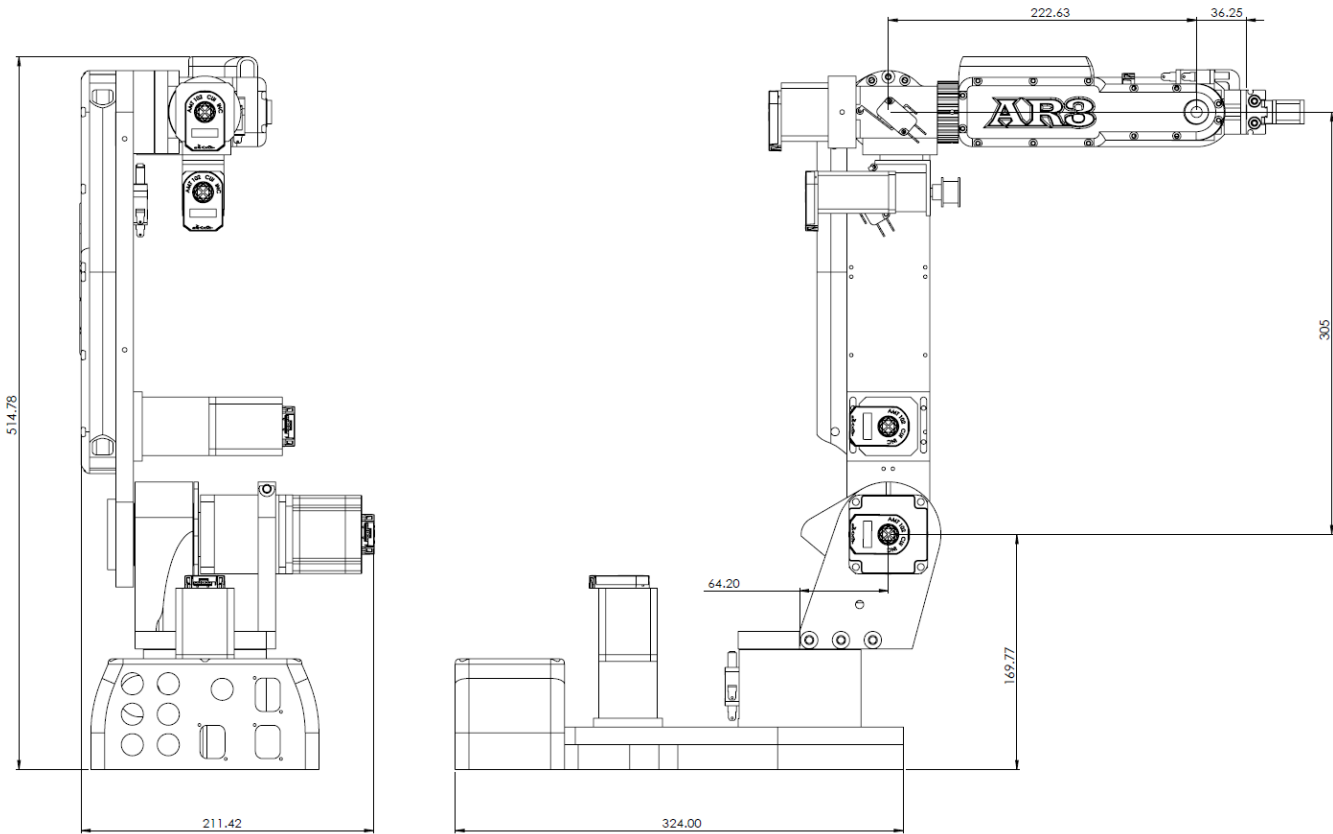

Reach – 24.75 inches (62.9cm)

Payload – 4.15 lbs (1.9kg)

Repeatability - .2mm

Robot weight (aluminum) – 27lbs (12.25kg)

Max Power Consumption – 8.25amp (198 watts)

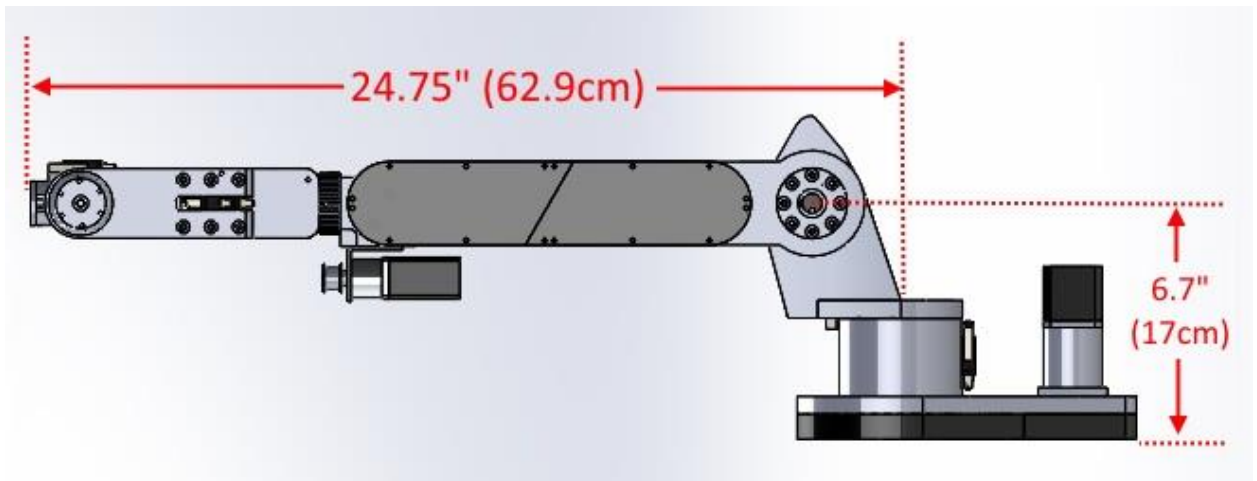

AR4-MK3 TEENSY 4.1 WIRING SCHEMATIC

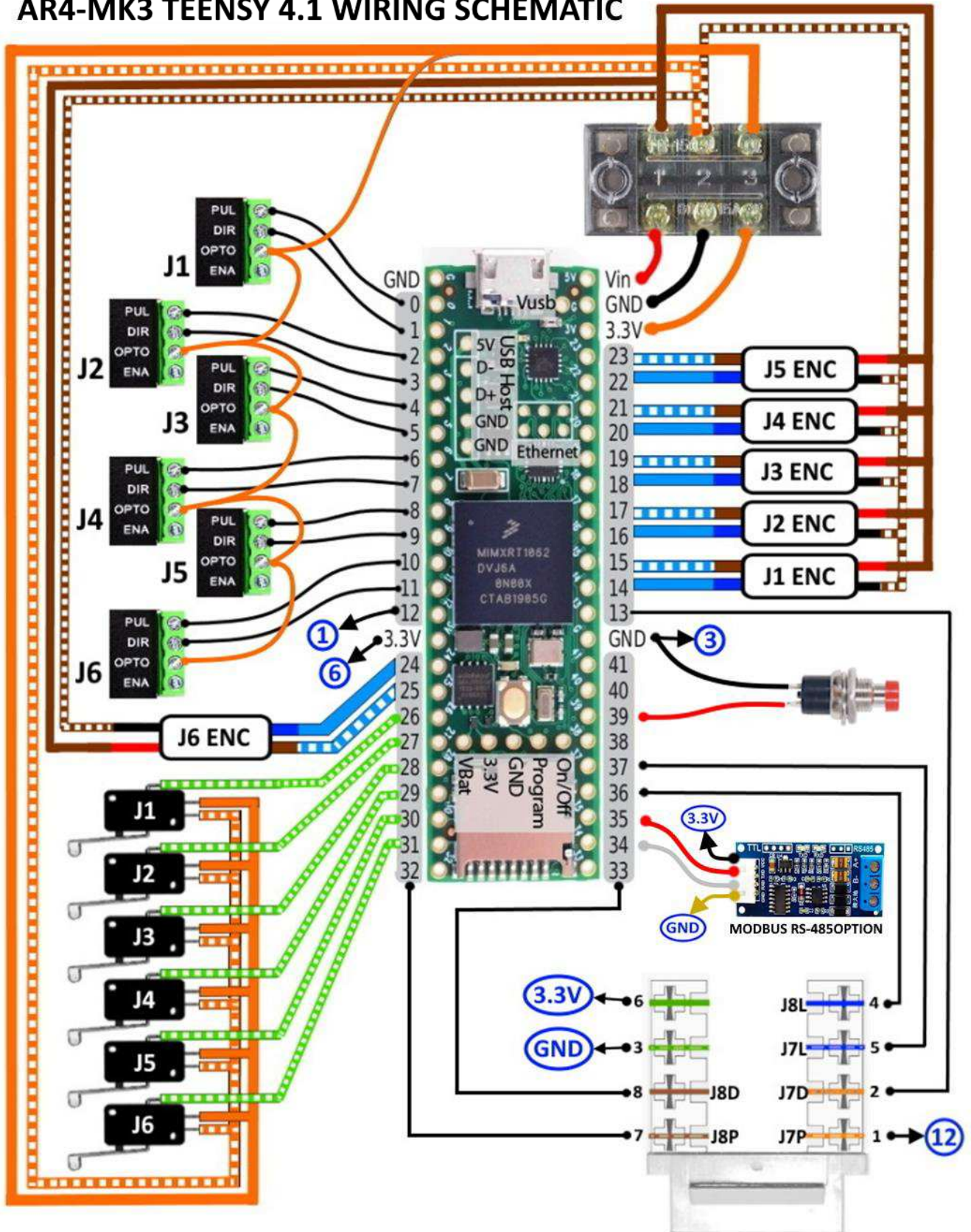

NANO WIRING FOR PERIPHERAL INPUT OUTPUTS AND GRIPPER CONTROL

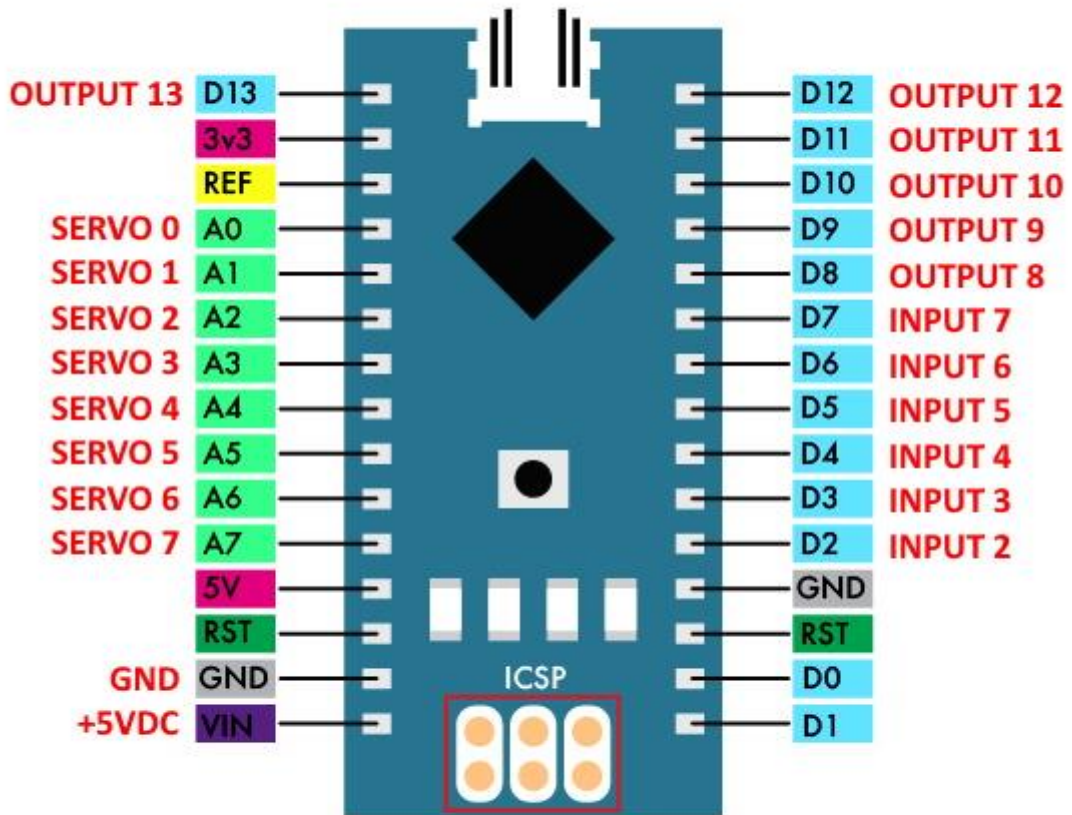

CHAPTER 8

STARTUP PROCEDURE

Please see the AR4 startup tutorial video:

<https://youtu.be/OL6lXu8VU4s>

If you have any issues connecting your teensy board to the software please also review the Teeny troubleshooting page here:

<https://www.pjrc.com/teensy/troubleshoot.html>

Before powering up your robot double check all connections per the wiring schematic. Check continuity on all wires and connectors for each motor, encoder and limit switch. It is imperative that all wire connectors are crimped or soldered carefully and checked with a volt meter.



- Review the AR4 software startup video found on the tutorials page at www.anninrobotics.com and install the AR4 teensy 4.1 sketch on your teensy board (*You will need to install the ModbusMaster library in the Arduino IDE*) and load the AR4 control software on your computer or laptop.
- After starting up the AR4 control software verify the log screen shows the message “**COMMUNICATIONS STARTED WITH TEENSY 4.1 BOARD**” and the system message at the top of the main control screen says “**SYSTEM READY**”.
- The first step is to check that each motor runs and jogs in both directions. At this point we do not yet want to troubleshoot any encoder issue or have any potential encoder issues cause confusion when checking the motors. For now select the checkboxes on the Config Settings tab to disable all the encoders:

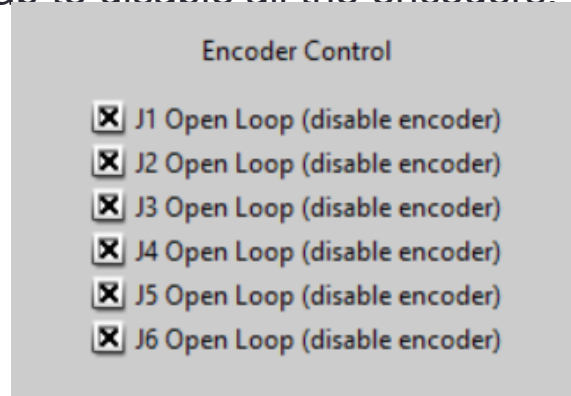

- On the Main Control screen jog each motor a small amount in each direction – set the jogging step value to 10 and press the + and – button for each joint.

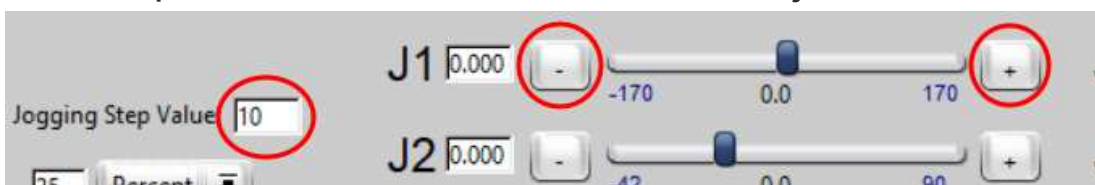

- If any of the motors do not move at all there are generally 2 things to look for, first check the motor power wiring for the A+A-B+B- wires, this includes checking the wiring between the drivers and the sockets, checking the cables, try swapping motor cables with a known good cable, check the plug wiring in the base of the robot. The second thing to check is the pulse wire from the teensy to the affected driver – if the driver is not getting the pulse signal it will not move in either direction.
- If one of the motors only jogs in one direction this is typically an issue with the dir wire from the teensy to the affected driver – check that this wire is properly connected.
- After it is verified that all motors can jog in each direction it is important to check that each motor is jogging in the correct directions for the positive and negative directions, it is possible for miswiring of the A+A-B+B- to cause the motors to turn in the incorrect directions. Refer to the following diagram and verify each joint is jogging in the correct direction. If any of the motors are not jogging in the correct direction check the motor wiring and verify if you are using a different driver that is doesn't have a direction dip switch set incorrectly.



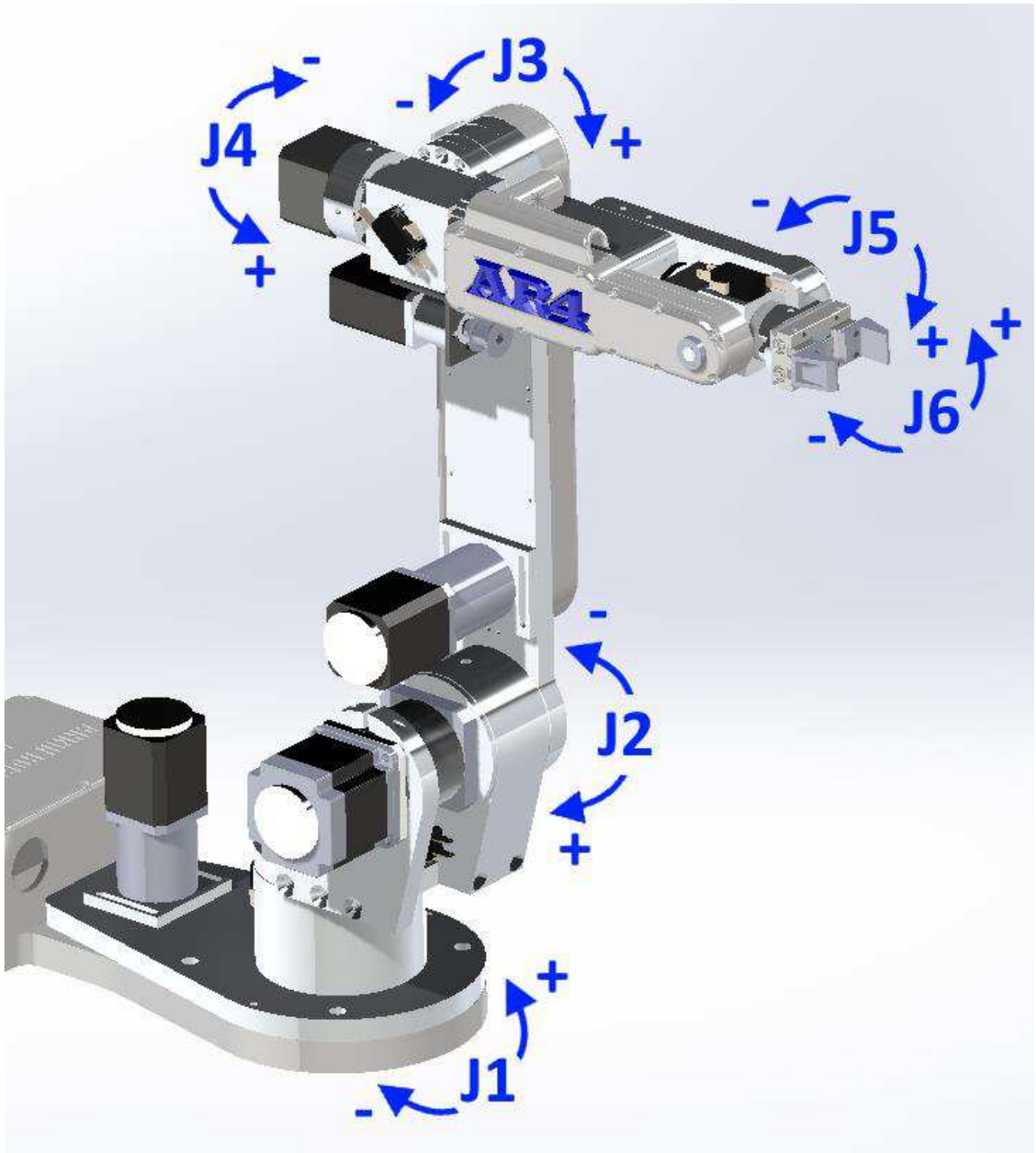

- After verifying each joint is jogging in the correct direction the next task is to verify each joint is jogging the correct distance. You can use a mechanical angle gauge but a digital angle gauge such as the one shown in the general assembly notes. Place the angle gauge on a flat surface of each joint and then verify when jogging that joint 10 degrees that it actually moves 10 degrees. For example on joint 3 place the gauge on the upper arm as shown – at this point it doesn't matter what position the joint is currently in, press the zero button – the gauge should read zero, now jog the joint down 10 degrees and verify it actually moves ten degrees.



- If you find a joint is not moving the correct distance the primary thing to check is the micro step settings on the driver, if the settings are incorrect the joint will not move the correct distance. The other mistake that I have seen is when the motors for J1 and J3 get mixed up and installed on the wrong joint.
- The next thing to check is each of the limit switches. Load the limit switch testing program: enter “test limit switches” in the program window and click the Load Program button.

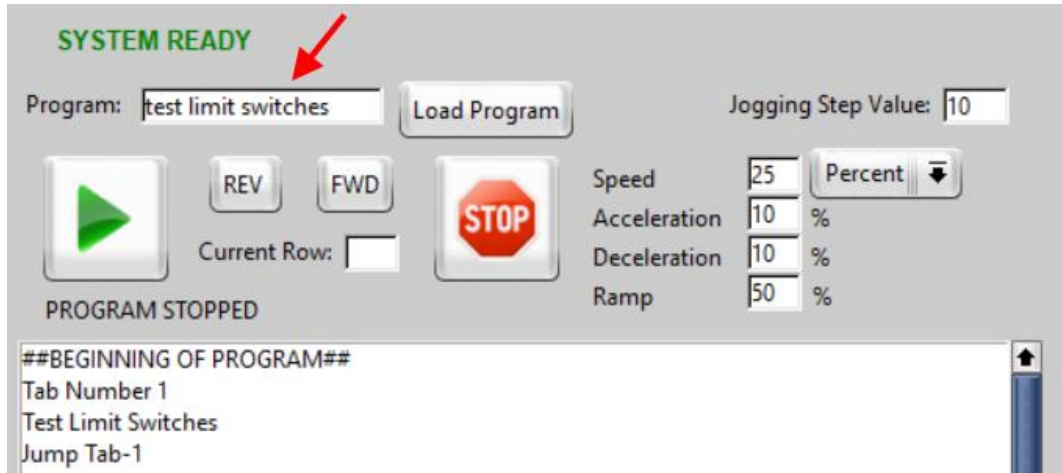

- Press the play button to run the program. When the program is running the manual entry field at the bottom of the screen will display a 0 or 1 value for each joint. You can now manually press each limit switch and verify it is working – the value should display 0 when the switch is not made and a 1 when the switch is made. NOTE: to test the J5 limit switch you will need a paper clip or small need nose pliers to reach in and pull on the switch lever arm. See example on next page checking the limit switch for Joint 1.

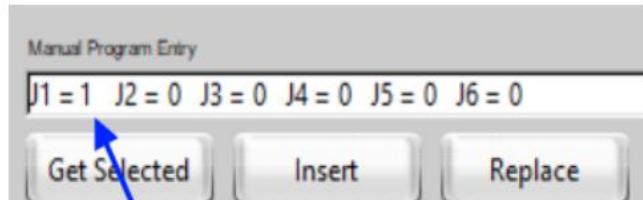

- If you find any of the limit switches are not responding first use a meter to verify that you are getting 5v on the left and center terminals of the distribution block in the base of the robot, then check that you are getting 3.3v on the right and center terminals of the distribution block. (the center terminal is GND, the right is +5 and the right is +3.3)
- Next check continuity from the switch terminals to the pins on the keystone jacks.
- The most common issue I see is the connection where the wires are punched down into the keystone jack – if you have bad signal or connection, I recommend removing the wire from the keystone jack, strip the end of that wire, tin the wire with solder and then re punch the soldered end into the keystone jack.
- Note that each limit switch should return GND to the respective teensy terminal when the switch is not made and return +3.3 to the teensy when the switch is made.



- The J4 timing screw may need to be adjusted so that it contacts the limit switch when joint 4 is rotated. Make sure the 24vdc power to the robot is turned off and then rotate J4 until the M3x6 button head screw contacts the limit switch. Turn the screw in or out appropriately so that the switch is contacted and verify that the J4 limit switch signal in the test limit switch program goes high when J4 is manually rotated.

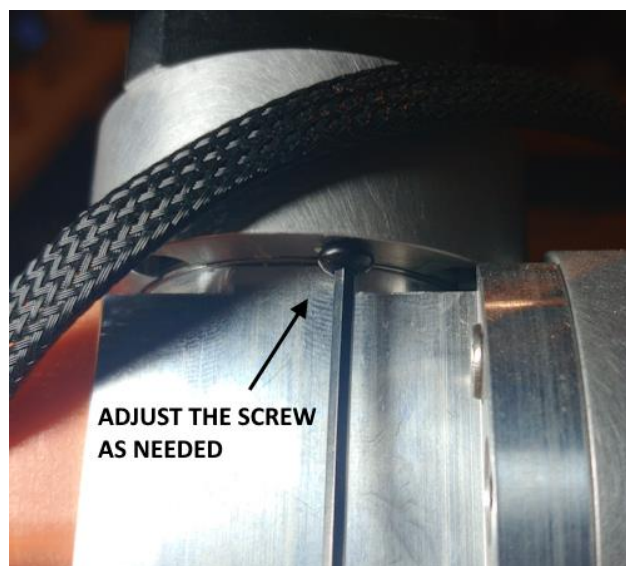
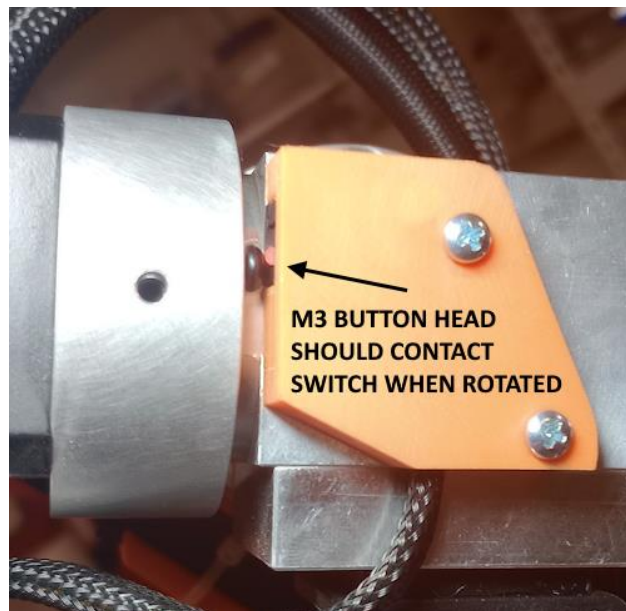

- Next we will check all the encoders, on the Config Settings tab uncheck the check boxes for disabling the encoders:

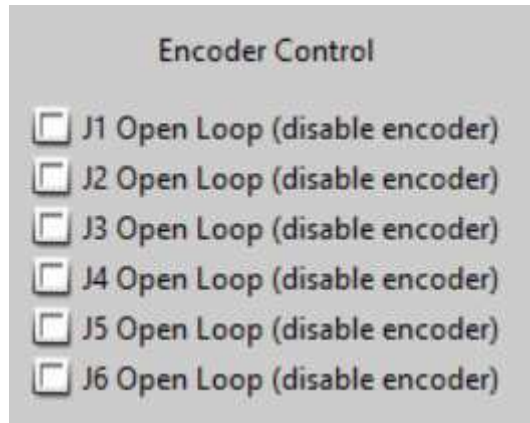

- Load the encoder testing program. Press the play button to run the program. When the program is running the system message in the manual entry field at the bottom of the screen will display a value of 1000 for each joint. Turn of power to your control enclosure to remove power from the robot motors (don't unplug the USB to your teensy board only shut off driver power). You can now manually manipulate each motor in both directions and verify the value shown for each encoder goes up or down depending on which direction you are moving each joint. See picture on next page to see what the screen should look like when testing the encoders.



- When testing the encoders the 1000 number and the number of counts it shows are arbitrary and only meant to show you a display of the encoder functioning.

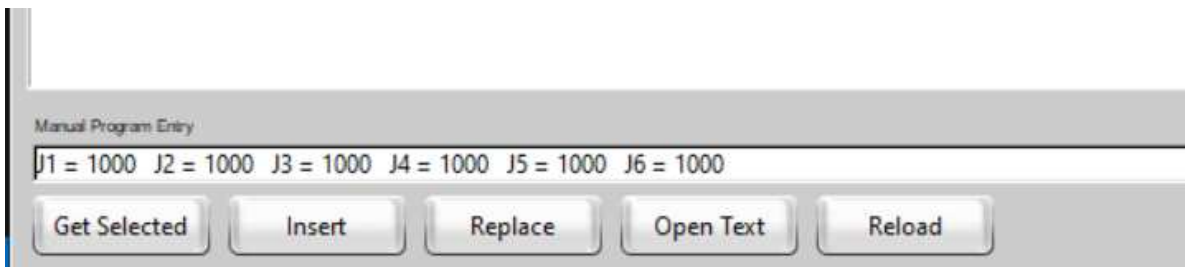

- If you find any of the encoders are not responding in either direction double check all of the wiring including the wiring of the keystone jacks as outlined in the previous section on checking the limit switch wiring.
- Next power your control enclosure back on and test jogging each joint – verify you do not get a joint collision or out of position alarm and that each joints position is reporting appropriately.



- If you jog a joint and you get a joint collision alarm check and see which direction the joint value is displaying – for example if you jog joint number one 10 degrees in the **positive** direction but the encoder corrects the display to show it actually moved 10 degrees in the **negative** direction you will need to reverse the AB phase being read in on the teensy. For example if you are having this issue on joint 1 open the teensy4.1 sketch and reverse the encoder pin values as shown in this example:

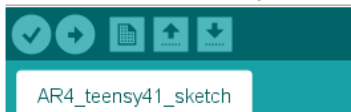

```
//set encoder pins
Encoder J1encPos(14, 15);
Encoder J2encPos(17, 16);
Encoder J3encPos(19, 18);
Encoder J4encPos(20, 21);
Encoder J5encPos(23, 22);
Encoder J6encPos(24, 25);
```

If you find you have this issue reverse the order of the encoder pins in the teensy 4.1 sketch and then reload the sketch on to your teensy board



```
//set encoder pins
Encoder J1encPos(15, 14);
Encoder J2encPos(17, 16);
Encoder J3encPos(19, 18);
Encoder J4encPos(20, 21);
Encoder J5encPos(23, 22);
Encoder J6encPos(24, 25);
```

- The last step is to check your robots calibration. From the Config Settings tab click the Calibrate joint only button for each joint. The joint will travel to its limit switch, it will calibrate that joint to its limit and then travel back to zero. If you find a joint is off or not at zero after the calibration enter the amount the joint is off in the calibration offsets window for that joint, click the save button and then retry the calibration. See example on the next page.



- This example is for joint #3, in the picture below I have properly calibrated joints 1 and 2 first so that joint 2 is at a perfect 90 degrees, then I ran the calibration for joint 3 and then placed a digital level on the upper robot arm. You can see in this picture the joint is at an angle of 2.8°



- I then enter -2.8 in the calibration offset window and click save.

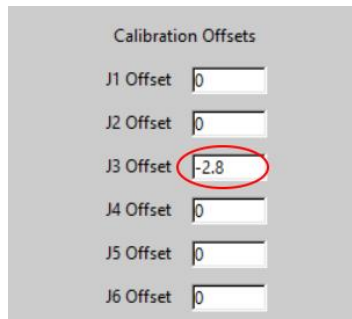

- Then after re-running the calibration the joint now calibrates correctly to a zero value.



This concludes the startup procedure, please review all the setup and programming videos on the tutorials page at www.anninrobotics.com



CHAPTER 9

ROBOT PROGRAMMING

Please see the AR4 programming tutorial video:

<https://youtu.be/GInNh6MS-Gc>

1. COMMUNICATION
2. SPEED / ACCELERATION /
DECELERATION
3. JOGGING
4. PROGRAMMING
5. CALIBRATION



I. COMMUNICATION

Determine which com port your Teensy 4.1 and Arduino is communicating on, you can find this Using Windows device manager, or you can open the Arduino sketch and click on the tools menu and then click on Port. Enter this in the "COM PORT" entry field for the device and click "Set Com". You should only have to do this once as the software will remember which com port the next time you open it.



2. SPEED / ACCELERATION / DECELERATION

The robots speed is set as a percentage of max speed. If you set the speed to 100 this will be the fastest the robot can move. Typical speed for jogging is between 10% and 25%. The acceleration and deceleration settings each have 2 parameters: a duration and a percentage. The duration is the percentage of the move you want the robot to accelerate or decelerate through, for example if you have a move that is 100mm long and you want the robot to quickly accelerate for only the first 5mm (or 5% of the move) you could set the Dur setting to 5 and then if you wanted the robot to come to a more gradual stop over the last 25mm (or 25% of the move) you could set the deceleration duration setting to 25. The second value which is percentage is a measure of amplitude, for example if you set the "speed %" setting to 10% it will accelerate or decelerate within 10% of whatever the speed setting is. For example, if your overall speed is 25% and your deceleration is 10% the robot will decelerate from 25% down to 2.5%. The Speed, Acc and Dec setting apply both to jogging and are applied to any positions you teach.



3. JOGGING

In the degrees to jog box enter the number of degrees you wish the robot to move and then press the corresponding "-" or "+" button to move each joint..The second row of jog buttons allow you to jog the robot in Cartesian coordinates; enter the distance in millimeters you wish the robot to move and press the corresponding "-" or "+" to jog the robot.The third row of jog buttons allow you to jog the robot in tool coordinates; enter the distance in millimeters you wish the robot to move and press the corresponding "-" or "+" to jog the robot - this jogs the robot according to the gripper: think of it as jogging the gripper around depending on whatever direction it is oriented.

You can also jog the robot using an Xbox controller. Install the Xbox software per the windows PC Xbox controller adapter directions.To test it In the Windows start menu type joy.cpl and then click on the menu option for the Xbox controller, this will bring up a window that you can verify all the buttons are working. In this AR2 software click the Xbox button, the indicators on the screen should turn green and allow you to jog the robot per the button list in the next section.When you turn on Xbox control all jog distances are set to start at 5.All jogging is done with the D pad (analog sticks are not used).There are 3 modes for Xbox jogging - joint, Cartesian and reorient.The controller starts in joint mode where the D pad will start out controlling J1 and J2, you can then press the X button to shift to control J3 and J4, then press X again to shift to J5 and J6.



Press the A button to shift to Cartesian jogging, you then can jog axis X and Y using the D pad. Press the X button again to shift to axis Z. Press the B button to control orientation directions.

- jog distance up / down (L & R trigger buttons)
- speed up / down (L & R bumper buttons)
- shift joint mode (X button)
- shift Cartesian mode (A button)
- shift reorient mode (B button)
- jog track (back button)
- jog directions (use D pad)
- teach position (Y button) *this will implement whichever move type you have selected from the dropdown.
- first DO on/off assignment on Input Output tab (start button)
*typical use for open close gripper



3. PROGRAMMING

a. Teaching Positions

Always select row in program window where you want the next move or instruction to be placed. From the move type drop down button select the move type you wish to insert and then press the "Teach New Position" button to insert the position into your program. All moves will apply the speed, acceleration and deceleration setting you have set to the move. Position move types are as follows:

- Move J - Move J is a joint move where all joints work together to complete the move, this will not necessarily be a straight line but a sweeping motion with all joints working together. This is the simplest and most common move to use.
- OFFS J - this is a joint move that is offset by the values of a stored position. this move will apply whatever stored position number you have set in the stored position field that is just above the "Teach New Position" button. (stored positions are explained in further detail below in the entry for Move SP).
- Move L - Move L is a linear move, this will execute a perfectly straight line to the position you teach. This program must send a series of waypoints that form the line to the Arduino, there is a couple second delay before any Move L while all waypoints are being transmitted.



- Move A - Move A is an arc move. You must teach 3 points to form an arc. First select "Move A beg" and teach the start point for your arc - the speed and orientation values for this first point will be applied to the entire arc move. Second you need to teach any mid-point on the arc - select "Move A Mid" and teach the second point. Finally select "Move A End" and teach the point you want at the end of your arc. Your command window will now have 3 lines of code in a row for each of the 3 points. When a "Move A Beg" line of code is executed the program will automatically run the next 2 lines of code to calculate the arc. The move will not work if these are out of order. There is a couple second delay before the Move A will execute while all waypoints to form the arc are being transmitted to the Arduino.

- Move C - Move C is a circle move. You must teach 3 points to form a circle. First select "Move C center" and teach the center point for your circle - the speed and orientation values for this first point will be applied to the entire circle move. Second you need to teach the start point on the circumference of the circle where you want the robot to begin and end the circle - select "Move C Start" and teach the second point. Finally select "Move C Plane" and teach a point anywhere on the same plane you want your circle, this point is only used to know which direction you want the circle to go and this third point defines the plane - in other words just teach another point on the circles circumference - it doesn't really matter where it is, it's not an executed point and only used for calculation



. Your command window will now have 3 lines of code in a row for each of the 3 points. When a "Move C Start" line of code is executed the program will automatically run the next 2 lines of code to calculate the circle. The move will not work if these are out of order. There is a couple second delay before the Move C will execute while all waypoints to form the arc are being transmitted to the Arduino.



- Move SP - SP stands for stored position. In the registers tab there are 16 stored positions you can set. You can set or save the X,Y,Z,Y,P,R for any position you want to execute later or multiple places in your program. When you teach a Move SP the robot will move to the position you have entered for the stored position on the register tab. *Stored positions can also be used for offsets - for example if you want the robot to come in above your part you may want to use an offset move with a stored position 25mm up in the Z direction - example: (0,0,-25,0,0,0).

- OFFS SP - this moves the robot to a stored position and then offsets that position by the value in another stored position. This is useful for stacking and placing parts in rows. This move will use the value in the stored position field that is just above the "Teach New Position" button for the primary move to execute, then for the stored position that it will be offset by it automatically picks the next stored position - but you can use the manual entry field to edit which stored position the move will be offset by (see section below on editing).



- Teach SP - this move command will insert 6 lines into your program which when executed will store the robots current position into a stored position register of your choice. This makes it easier to populate stored positions as you need.

The Stored Position button will allow you to enter lines of code that set individual elements of the X,Y,Z,Y,P,R in a stored position.

The modify position button is only used with Move J and allow you to modify the Move J line in your program that is currently highlighted.

The Delete button allows you to delete any line of code that is currently selected.

b. Pausing

- The wait time button inserts a line that will pause the program for the amount of time entered in seconds.

- The wait input on button will wait for the Arduino input entered in the entry field to come on before moving forward in the program. This can be used as a way to make the robot wait for something else to happen before proceeding or it can be placed at the beginning of a program as a way to have an automated start signal.

- The wait input off button will wait for the Arduino input entered in the entry field to turn off before moving forward in the program.



c. IO

- The set output on or set output off buttons allow you to insert a line of code that will turn Arduino IO of your choice on or off (see bottom on input outputs tab for available IO pins on the Arduino Mega). For example, if you have a pneumatic gripper you would hook up your solenoid per the wiring harness manual to output Arduino pin #38 and enter a line of code "Out On = 38" to control your gripper.

d. Navigation

You can create as many program routines as you like. Enter the name of the program you would like to create in the program field and press "load program", if the program does not already exist it will be created, if you have already created a program of that name it will be loaded. Programs are created in your software folder and can be deleted from that file location if no longer needed.

- The "Call Program" button allows you to insert a line of code that calls a program.

- The "Return" button inserts a line of code that will allow the called program to return to the program it came from. *note you cannot call another program from within a program that has already been called, you must return to the main program before calling another program. For example, you will likely want to create a program called "Main" from that program you might call a program called "Pickup Part" at the end of pickup part you will want to insert a "Return" line to get back to the "Main" program, then you can do other things or call other programs. You cannot call another program from "Pickup Part" you must first return to the main program.



- the "Create Tab" button allows you to create markers in your program that you can jump or navigate to based on conditions. *note you cannot have 2 tabs with the same number - each tab needs a new number. This functionality is very similar to basic programming.

- The "Jump to Tab" button allows you to jump to a tab, for example you could put "Tab 1" at the top of your program and at the bottom put a "Jump to Tab 1" and then your program would loop indefinitely.

The "If Register Jump" button allows you to jump to a tab based on the condition of a register. For example you could have a looping program as previously described but then add a line into your program that increments a register and then add a line prior to "Jump to Tab 1" that says "If Register 1 = 5 Jump to Tab 2" and then place a "Tab 2" at the very bottom after "Jump to Tab 1" so that the program will run 5 times and then jump to Tab 2 and stop.



e. Registers

The "Register" button allows you to set a register to a static value or you can add a "++" before the number and the register will then be incremented by the amount. For example, if you just enter a "1" it will always set that register to a value of 1 but if you enter "++1" it will then increment that register by 1 every time the line is run so that you can use this for counting. You can enter any number, for example you could enter "++3" and count by 3's if you like. The same is true for counting down or decrementing - just place a "--" before the number.

f. Servos

The Servo button allows you to control external servos - it's not for the robot itself, it's for use if you have a servo gripper or a servo actuator that you want the robot program to control. For example, if you had a servo gripper that you had hooked up to Arduino pin A0 per the wiring harness manual you could then insert a line of code "Servo number 0 to position: 180" to open the gripper and "Servo number 0 to position: 0" to close your gripper.



g. Editing lines of code

You can select a line of code in your command window and then press the "get selected" button, this will copy that line into the manual entry field. You can now edit the line of code in the manual entry field, some examples might be: changing the stored position number, changing a position, changing the robot speed or acceleration. Now with your edited line of code you can reselect the original line of code in your command window and then press the "replace" button and the old line of code will be replaced with the new edited line. The "insert" button will insert the text from the manual entry field into your program without replacing - you can use this to insert comments or hand written lines of code using the insert button, this can be used to copy a line of code from the program and then paste or insert in numerous places in the program.



4. CALIBRATION

a. Auto Calibration

Pressing the auto calibration button will auto calibrate all axis. The robot will run to its full limit in the default directions and set each of the joint values accordingly. You can also use the individual buttons to calibrate each axis one at a time.

b. Force to midrange Calibration

This button allows you to force each axis to be calibrated at its mid-point. This is only used when setting up your robot - for example if your robot is not yet calibrated and you are trying to jog a joint around and you hit an axis limit this button will allow you to do what you need to do before you can auto calibrate your robot. Only use this button during construction and setup.



5. IO TAB

The buttons on the IO tab are simply a shortcut for you to quickly toggle servos or outputs. For example, if your gripper was wired to Arduino output #38 you could enter 38 into one of the "DO ON / OFF" fields and quickly open and close your gripper without having to execute a line of code from the program console.

ALSO, PLEASE REFER TO ALL OF THE PROGRAMMING AND CALIBRATION VIDEOS FOR FURTHER INFORMATION:

<https://www.anninrobotics.com/tutorials>



Version Log:

- 1.0 3/24/24 – original issue
- 1.1 6/15/24 – fixes several typos and updated J3 spindle pic on page 123
- 1.2 7/22/24 – fixed screw count on BOM & typo on page 57
- 1.3 2/5/25 – added Modbus option
- 1.4 3/19/25 – updated to HTD J3 belt and pulleys
- 1.5 7/21/25 – added teensy troubleshooting link and fixes typos.
- 1.6 8/30/25 – change drive microsteps
- 1.7 11/13/25 – changed J5 limit switch

